

# Design of fault-tolerant on-board networks with variable switch sizes

Olivier Delmas, Frédéric Havet, Mickaël Montassier, Stéphane Pérennes

► **To cite this version:**

Olivier Delmas, Frédéric Havet, Mickaël Montassier, Stéphane Pérennes. Design of fault-tolerant on-board networks with variable switch sizes. Theoretical Computer Science, Elsevier, 2015, 562, pp.75-89. 10.1016/j.tcs.2014.09.034 . hal-01111370

**HAL Id: hal-01111370**

**<https://hal.inria.fr/hal-01111370>**

Submitted on 13 Nov 2017

**HAL** is a multi-disciplinary open access archive for the deposit and dissemination of scientific research documents, whether they are published or not. The documents may come from teaching and research institutions in France or abroad, or from public or private research centers.

L'archive ouverte pluridisciplinaire **HAL**, est destinée au dépôt et à la diffusion de documents scientifiques de niveau recherche, publiés ou non, émanant des établissements d'enseignement et de recherche français ou étrangers, des laboratoires publics ou privés.

# Design of fault-tolerant on-board networks with variable switch sizes

O. Delmas\*, F. Havet<sup>†</sup>, M. Montassier<sup>‡</sup> and S. Pérennes<sup>†</sup>

October 23, 2016

## Abstract

An  $(n, k, r)$ -network is a triple  $N = (G, \text{in}, \text{out})$  where  $G = (V, E)$  is a graph and  $\text{in}, \text{out}$  are non-negative integer functions defined on  $V$  called the *input* and *output* functions, such that for any  $v \in V$ ,  $\text{in}(v) + \text{out}(v) + \text{deg}(v) \leq 2r$  where  $\text{deg}(v)$  is the degree of  $v$  in the graph  $G$ . The total number of inputs is  $\text{in}(V) = \sum_{v \in V} \text{in}(v) = n$ , and the total number of outputs is  $\text{out}(V) = \sum_{v \in V} \text{out}(v) = n + k$ .

An  $(n, k, r)$ -network is *valid*, if for any *faulty* output function  $\text{out}'$  (that is such that  $0 \leq \text{out}'(v) \leq \text{out}(v)$  for any  $v \in V$ , and  $\text{out}'(V) = n$ ), there are  $n$  edge-disjoint paths in  $G$  such that each vertex  $v \in V$  is the initial vertex of  $\text{in}(v)$  paths and the terminal vertex of  $\text{out}'(v)$  paths.

We investigate the design problem of determining the minimum number  $\mathcal{N}(n, k, r)$  of vertices in a valid  $(n, k, r)$ -network and of constructing minimum  $(n, k, r)$ -networks, or at least valid  $(n, k, r)$ -networks with a number of vertices close to the optimal value.

We first give some upper bounds on  $\mathcal{N}(n, k, r)$ . We show  $\mathcal{N}(n, k, r) \leq \left\lceil \frac{k+2}{2r-2} \right\rceil \left\lceil \frac{n}{2} \right\rceil$ . When  $r \geq k/2$ , we prove a better upper bound:  $\mathcal{N}(n, k, r) \leq \frac{r-2+k/2}{r^2-2r+k/2}n + O(1)$ .

Next, we establish some lower bounds. We show that if  $k \geq r$ , then  $\mathcal{N}(n, k, r) \geq \frac{3n+k}{2r}$ . We improve this bound when  $k \geq 2r$ :  $\mathcal{N}(n, k, r) \geq \frac{3n + 2k/3 - r/2}{2r - 2 + \lfloor \frac{3r}{k} \rfloor}$ .

Finally, we determine  $\mathcal{N}(n, k, r)$  up to additive constants for  $k \leq 6$ .

**Keywords** Fault tolerance, switching networks, flow networks, vulnerability.

## 1 Introduction

Modern telecommunication satellites are very complex to design, and one of the most important industrial issues is to provide robustness at the lowest cost possible. Alcatel Space Industries is a major provider of telecommunication satellites. A key component of their satellites is an interconnection network which allows the redirection of signals received by the satellite to a set of amplifiers from which the signals are retransmitted (a detailed overview on the model and the motivations can be found in [6, 3]). For reliability convenience, wave guide technology has been chosen by Alcatel Space Industries to build these on-board networks (for background information see [8, 12]). So this interconnection network consists of expensive four-port switches, of wave guides linking these switches, of inputs (where the signals enter the network) and of outputs (where the signals leave the network). Before being transmitted downwards, the signals must be amplified, so the outputs are amplifiers based on *Travelling Wave Tube Amplifier* technology [8, 12]. However, amplifiers are prone to failure. Switches are also prone to failure, but due to the wave guide technology, the probability that a fault appears on a switch is much smaller than the probability that a fault appears on an amplifier. For this reason, only faults on amplifiers are considered [3]. In the past,

\*Univ. Bordeaux, LaBRI, UMR 5800, F-33400 Talence, France • CNRS, LaBRI, UMR 5800, F-33400 Talence, France.

<sup>†</sup>COATI Project, I3S (CNRS/UNSA) & INRIA, 2004 route des Lucioles BP 93, 06902 Sophia-Antipolis Cedex, France. Partially supported by the ANR project Gratel

<sup>‡</sup>Univ. Montpellier 2, France • CNRS - LIRMM 161 rue Ada, 34095 Montpellier Cedex 5, France

an important number of techniques have been proposed to increase the reliability and the fault-tolerance of multistage interconnection networks or switching networks (see [1, 11, 7]). These techniques consider networks with switches (or links between switches) subject to failure and do not consider faulty outputs. This previous work focused on aspects such as deadlock and adaptive routing schemes that are not relevant to our problem.

In this paper, following [3], [5] and [10], we focus on designing networks that are able to reroute the input signals to operational output ports in the presence of faulty output ports. Since the components of a satellite cannot be repaired, redundant amplifiers are added and the interconnection network satisfies the following fault tolerance property: the network connects the set of input ports with the set of output ports, and for any set of at most  $k$  output port failures, there exists a set of edge-disjoint paths connecting the input ports to the non-faulty output ports. Since each switching device induces a high cost, these interconnection networks are constructed with the fewest switches possible, or at least with a number of switches close to the minimum value. The considered networks are controlled centrally from Earth. Each time some used amplifiers become faulty, this controller sends messages to the switches to make them change position so that the inputs are still connected to non-faulty amplifiers.

Other variations of the initial problem have been considered in which there are two kinds of inputs in order to guarantee a certain quality of service [4, 10], but they will not be considered in this paper.

The existing switches currently have four ports. The problem was initially studied for such switches in [3] ( $k \leq 4$  failures), and then in [5] (up to 12 failures). For this, the cheapest type of switch, all wave guides are drawn in the plane and due to technological constraints, they should not cross. For four-port switches, this was not problematic since there is a 2-dimensional switch which is as powerful as the one realizing all possible matchings of ports (see [3]). However, for a larger number of ports, the types of switches that can be built in the plane under this non-crossing constraint are not very powerful and do not allow the construction of networks with sufficiently few vertices. For this reason, in this paper we seek to design on-board networks with more powerful switches, that is 3-dimensional switches with more than four ports. In practice, such a switch will be expensive. Hence less powerful but cheaper switches are also envisioned. For sake of simplicity, we consider here a simple model in which every switch has  $2r$  ports and can realize all matchings among them. The aim is to provide elements to determine the number of ports minimizing the cost of the network (this will depend on the cost of construction of  $2r$ -port switches). Obviously, the larger the number of ports, the more expensive the switches will be, but fewer are required. So the cost of such a network involves a trade-off between the total number of switches and the cost of a switch. In this paper, we give some bounds on the minimum number of  $2r$ -port switches in interconnection networks with  $n$  inputs and  $n + k$  outputs.

Generalizing the definition of  $(n, k)$ -networks introduced in [3] and [5], we define  $(n, k, r)$ -networks as follows: An  $(n, k, r)$ -network is a triple  $N = (G, \text{in}, \text{out})$  where  $G = (V, E)$  is a graph and  $\text{in}, \text{out}$  are non-negative integer functions defined on  $V$  called *input* and *output* functions, such that for any  $v \in V$ , its number of ports  $\text{por}(v)$  defined by  $\text{por}(v) = \text{in}(v) + \text{out}(v) + \text{deg}(v)$  is at most  $2r$ . ( $\text{deg}(v)$  denotes the degree of  $v$  in the graph  $G$ , that is the number of edges of  $G$  incident to  $v$ .) Let  $i$  and  $o$  be two non-negative integers. An  $(i|o)$ -switch or *switch of type  $i|o$*  is a switch  $s$  with  $i$  inputs and  $o$  outputs, i.e. with  $\text{in}(s) = i$  and  $\text{out}(s) = o$ . The total number of inputs is  $\text{in}(V) = \sum_{v \in V} \text{in}(v) = n$  and the total number of outputs is  $\text{out}(V) = \sum_{v \in V} \text{out}(v) = n + k$ .

Any integer function  $\text{out}'$  defined on  $V$  such that  $0 \leq \text{out}'(v) \leq \text{out}(v)$  for any  $v \in V$ , and  $\text{out}'(V) = n$  is called a *faulty output function*. Note that  $\text{out}(v) - \text{out}'(v)$  is the number of faults at vertex  $v$ . An  $(n, k, r)$ -network is *valid*, if for any faulty output function  $\text{out}'$ , there are  $n$  edge-disjoint paths in  $G$  such that each vertex  $v \in V$  is the initial vertex of  $\text{in}(v)$  paths and the terminal vertex of  $\text{out}'(v)$  paths.

Let us denote the minimum number of vertices in a valid  $(n, k, r)$ -network by  $\mathcal{N}(n, k, r)$ . A valid  $(n, k, r)$ -network with exactly  $\mathcal{N}(n, k, r)$  vertices is called a *minimum  $(n, k, r)$ -network*. The design problem consists of determining  $\mathcal{N}(n, k, r)$  and of constructing minimum  $(n, k, r)$ -networks, or at least valid  $(n, k, r)$ -networks with a number of vertices close to the optimal value.

Let us present an example: We would like to construct valid  $(4, 4, 2)$ -networks. A first solution is depicted in Figure 1. The network  $N_1$  is composed of eight switches  $u_i, v_i$  for  $1 \leq i \leq 4$ . The associated graph  $G = (V, E)$  is the  $4 \times 2$  grid. The input and output functions are defined as follows:  $\text{in}(v_i) = 1$ ,

$\text{in}(u_i) = 0$  for  $1 \leq i \leq 4$ , and  $\text{out}(v_2) = \text{out}(v_3) = 0$ ,  $\text{out}(v_1) = \text{out}(u_2) = \text{out}(u_3) = \text{out}(v_4) = 1$ ,  $\text{out}(u_1) = \text{out}(u_4) = 2$ .

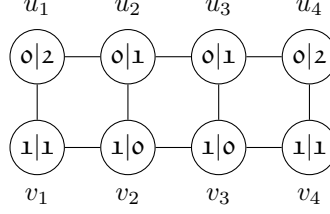

Figure 1: A first solution: the network  $N_1$ .

For any faulty output function  $\text{out}'$ , it is easy to see that there are four edge-disjoint paths in  $G$  such that each vertex  $v \in V$  is the initial vertex of  $\text{in}(v)$  paths and the terminal vertex of  $\text{out}'(v)$  paths. This implies that this network is valid. It follows that  $\mathcal{N}(4, 4, 2) \leq 8$ . But this solution is not the best possible. The network depicted in Figure 2 is valid and contains only five switches. Moreover we can prove that  $\mathcal{N}(4, 4, 2) = 5$ .

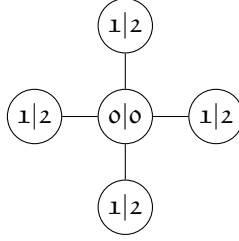

Figure 2: A better solution: the network  $N_2$ .

In this paper, we first give some general lower and upper bounds on  $\mathcal{N}(n, k, r)$ . We then give optimal values up to additive constants when  $k \leq 6$  and exhibit (almost) minimum networks. We prove the following bounds:

1. For any  $n, k, r$ ,  $\mathcal{N}(n, k, r) \leq \left\lceil \frac{k+2}{2r-2} \right\rceil \frac{n}{2}$ .
2. For  $k \geq 3$  and  $r \geq k/2$ ,  $\mathcal{N}(n, k, r) \leq \frac{r-2+k/2}{r^2-2r+k/2}n + O(1)$ .
3. For  $k \geq r$ ,  $\frac{3n+k}{2r} \leq \mathcal{N}(n, k, r)$ .
4. For  $k \geq 2r$ ,  $\frac{3n + 2k/3 - r/2}{2r - 2 + \lfloor \frac{k}{r} \rfloor} \leq \mathcal{N}(n, k, r)$ .
5. For  $k \in \{1, 2\}$  and  $r \geq 1$ ,  $\mathcal{N}(n, k, r) = \left\lceil \frac{n}{r-1} \right\rceil$ .
6. For  $k \in \{3, 4\}$  and  $r \geq 3$ ,  $\mathcal{N}(n, k, r) = \frac{r}{r^2-2r+2}n + \Theta(1)$ .
7. For  $k \in \{5, 6\}$  and  $r \geq 7$ ,  $\mathcal{N}(n, k, r) = \frac{r+1}{r^2-2r+3}n + \Theta(1)$ .

## 2 Properties of minimum networks and Cut Criterion

Obviously, if  $2n + k = \text{in}(V) + \text{out}(V) \leq 2r$ , then a network with one switch connected to all inputs and outputs is valid, and thus  $\mathcal{N}(n, k, r) = 1$ . Hence in the following, we will assume that  $2r < 2n + k$ .

If  $k \leq k'$ , we can easily obtain a valid  $(n, k, r)$ -network from a valid  $(n, k', r)$ -network by removing an arbitrary set of  $k' - k$  outputs.

**Proposition 1** *If  $k \leq k'$ , then  $\mathcal{N}(n, k, r) \leq \mathcal{N}(n, k', r)$ .*

Before we proceed with the lower and upper bounds on  $\mathcal{N}(n, k, r)$ , we make an observation on the structure of valid  $(n, k, r)$ -networks. We are free to add an edge between two unused ports as long as there are two of them. Hence we can assume that in an  $(n, k, r)$ -network all switches have  $2r$  ports, with an exception of one having  $2r - 1$  ports, if  $k$  is odd. Let  $\epsilon(k) = 1$  if  $k$  is odd, and  $\epsilon(k) = 0$  otherwise.

**Proposition 2** *There is a minimum  $(n, k, r)$ -network in which all switches have  $2r$  ports except exactly  $\epsilon(k)$  which have  $2r - 1$  ports.*

A switch with  $2r - 1$  ports is called *defective*. In the remainder of this paper, we assume that all switches of an  $(n, k, r)$ -network have  $2r$  ports except  $\epsilon(k)$  which are defective.

All the results that will be proved in this paper rely on Lemma 3, which gives a necessary and sufficient condition, called the *Cut Criterion*, for an  $(n, k, r)$ -network to be valid. It extends a result of [5] for  $r = 2$  and easily follows from the Ford-Fulkerson Theorem [9] (Theorem 1.1 p.38).

Let  $W$  be a set of switches of an  $(n, k, r)$ -network. Its number of inputs and outputs  $\text{in}(W) = \sum_{v \in W} \text{in}(v)$  and  $\text{out}(W) = \sum_{v \in W} \text{out}(v)$ , respectively. Denote by  $\Gamma(W)$  the set of edges with one endvertex in  $W$  and the other in  $\overline{W} = V \setminus W$  and set  $\text{deg}(W) = |\Gamma(W)|$ .

The *excess* of  $W$ , denoted  $\text{exc}(W)$ , is defined by  $\text{exc}(W) = \text{deg}(W) - \text{in}(W) + \text{out}(W) - \min\{\text{out}(W), k\}$ . Intuitively,  $\text{in}(W) - \text{out}(W) + \min\{\text{out}(W), k\}$  is the difference between the number of inputs in  $W$  and the minimum number of outputs in  $W$  over all possible faulty output functions. Hence it corresponds to (a lower bound of) the number of paths with input in  $W$  and terminal vertex in  $\overline{W}$  in the worst case. Those signals paths use distinct edges of  $\Gamma(W)$ . Thus, if the network is valid,  $\text{deg}(W)$  must be at least  $\text{in}(W) - \text{out}(W) + \min\{\text{out}(W), k\}$ , that is  $\text{exc}(W) \geq 0$ . We now show that this necessary condition is also sufficient.

**Lemma 3 (Cut Criterion)** *An  $(n, k, r)$ -network is valid if and only if every set of vertices  $W \subset V$  has non-negative excess.*

The proof of this lemma is identical to the proof for  $(n, k, 2)$ -networks given in [5].

**Proof** Let  $\text{out}'$  be a fixed faulty output function, then a supply/demand flow problem is defined by an integer (not necessarily positive) demand at each vertex  $v$ . In our case, the demand of a vertex  $v \in V$  is  $\text{demand}(v) = \text{out}'(v) - \text{in}(v)$ . Note that  $\text{demand}(V) = 0$ , which is always the case for supply/demand problems. A variant of the Ford-Fulkerson Theorem states that the supply/demand problem is feasible if and only if

$$\forall W \subset V : \text{deg}(W) \geq \text{demand}(\overline{W}) = \text{out}'(\overline{W}) - \text{in}(\overline{W}) = \text{in}(W) - \text{out}'(W).$$

The  $(n, k, r)$ -network is valid if all supply/demand flow problems defined by the possible faulty output functions are feasible. Therefore the  $(n, k, r)$ -network is valid if and only if

$$\forall W \subset V : \text{deg}(W) \geq \text{in}(W) - \min\{\text{out}'(W) \mid \text{out}' \text{ faulty output function}\}. \quad (1)$$

By definition,  $\min\{\text{out}'(W) \mid \text{out}' \text{ faulty output function}\}$  is the minimum number of non-faulty outputs in  $W$ . This minimum is attained either by choosing all outputs in  $W$  to be faulty when  $\text{out}(W) \leq k$ , or by choosing  $k$  outputs in  $W$  to be faulty when  $\text{out}(W) \geq k$ .

Hence,  $\min\{\text{out}'(W) \mid \text{out}' \text{ faulty output function}\} = \text{out}(W) - \min\{\text{out}(W), k\}$ . The property follows then from Equation (1).  $\square$

Using the Cut Criterion, we shall show some properties of minimum  $(n, k, r)$ -networks.

**Proposition 4**

- (i) *In a valid  $(n, k, r)$ -network, there is no switch with more than  $r$  outputs.*
- (ii) *In a minimum  $(n, k, r)$ -network, there is no switch with  $r$  (or more) inputs.*

**Proof** Let  $N$  be a valid  $(n, k, r)$ -network.

(i) Suppose for a contradiction that  $N$  contains a switch  $s$  with  $\text{out}(s) \geq r + 1$ . Let  $W = V \setminus \{s\}$ . As  $2n + k > 2r$ , the set  $W$  is not empty. Then  $\text{deg}(W) = \text{deg}(s) \leq 2r - \text{in}(s) - \text{out}(s)$ ,  $\text{in}(W) = n - \text{in}(s)$  and  $\text{out}(W) = n + k - \text{out}(s)$ . If  $k \leq \text{out}(W)$ , then  $\text{exc}(W) \leq 2r - 2\text{out}(s) \leq -2$  which contradicts the Cut Criterion. If  $k > \text{out}(W)$  then  $\text{exc}(W) \leq 2r - n - \text{out}(s) < r - n < 0$  because  $2n + k > 2r$ . Again this contradicts the Cut Criterion.

(ii) Suppose that  $N$  contains a switch  $s$  with  $\text{in}(s) \geq r$ . If  $\text{in}(s) > r$  or  $\text{in}(s) = r$  and  $\text{out}(s) \geq 1$ , then  $\{s\}$  has negative excess which contradicts the Cut Criterion. If not,  $s$  is incident to  $r$  links  $e_1, \dots, e_r$ . Now the  $(n, k, r)$ -network obtained from  $N$  by removing  $s$  and adding one input to the endvertex of each  $e_i$  is also valid and so  $N$  is not minimum.  $\square$

Proposition 4-(ii) asserts a switch has at most  $r - 1$  inputs in a minimum  $(n, k, r)$ -network. As observed in [5] for  $r = 2$ , switches with  $r - 1$  inputs, called *block switch*, play a special role. Non-block switches are called *S-switches*. We define *blocks* as maximum connected subgraphs made of block switches.

**Proposition 5** Let  $N$  be a minimum  $(n, k, r)$ -network for  $k \geq 3$ . Then the following hold:

- the blocks of  $N$  are trees and contain at most 2 outputs;
- for any block  $B$  of  $N$ ,  $\text{deg}(B) = \text{in}(B) + 2 - \text{out}(B)$  unless it contains the defective vertex in which case  $\text{deg}(B) = \text{in}(B) + 1 - \text{out}(B)$ .

**Proof** Set  $N = (G, \text{in}, \text{out})$ .

Suppose for a contradiction that there is a cycle  $C$  of  $q$  switches in a block  $B$ . Then  $\text{in}(C) = (r - 1)q$ . Moreover, there are  $q$  edges between switches of the cycle. So  $\text{deg}(C) \leq 2rq - 2q - \text{in}(C) - \text{out}(C) \leq (r - 1)q - \text{out}(C)$ . Hence  $\text{exc}(C) \leq \min\{\text{out}(C), k\}$ . Since  $\text{exc}(C) \geq 0$  by the Cut Criterion,  $\text{out}(C) = 0$  and  $\text{deg}(C) = (r - 1)q$ . Consider the network  $N'$  obtained by removing  $C$  and adding one input to a vertex  $v$  per edge from  $v$  to  $C$ . Formally  $N' = (G - C, \text{in}', \text{out})$  with  $\text{in}'(v) = \text{in}(v) + |\{e = vu \mid e \in E(G), u \in V(C)\}|$ . It is simple matter to see that  $N'$  is a valid  $(n, k, r)$ -network, because in  $N$ ,  $(r - 1)q$  paths must leave  $C$ . This contradicts the minimality of  $N$ . Hence the blocks are acyclic and so are trees since they are connected by definition.

Consider a block  $B$  with  $q$  switches. Then there are  $q - 1$  edges between switches of  $B$  and  $\text{in}(B) = (r - 1)q$ . So  $\text{deg}(B) \leq 2rq - 2q + 2 - \text{in}(B) - \text{out}(B) \leq (r - 1)q + 2 - \text{out}(B)$ . Hence  $\text{exc}(B) \leq 2 - \min\{\text{out}(B), k\}$ . By the Cut Criterion,  $\text{exc}(B) \geq 0$ , so  $\text{out}(B) \leq 2$  as  $k \geq 3$ .

Note that if  $B$  has no defective vertex, then the inequality above is an equality so  $\text{deg}(B) = (r - 1)q + 2 - \text{out}(B) = \text{in}(B) + 2 - \text{out}(B)$ . Similarly, if  $B$  contains the defective vertex, then  $\text{deg}(B) = \text{in}(B) + 1 - \text{out}(B)$ .  $\square$

In order to prove that a network is valid, by Lemma 3, we need to prove that every set of switches has non-negative excess. We now prove that it is in fact sufficient to prove it for connected sets.

**Lemma 6** If  $W$  is not connected and  $\text{exc}(W) < 0$ , then  $W$  has a connected component  $W_1$  such that  $\text{exc}(W_1) < 0$ . Hence a network is valid if and only if every connected subset has non-negative excess.

**Proof** Let  $W_i$ ,  $1 \leq i \leq l$ , be the connected components of  $W$ . Then  $\text{exc}(W) = \sum_{i=1}^l \text{exc}(W_i)$ . Thus, if  $\text{exc}(W) < 0$ , then there is at least one  $W_i$  which has also negative excess.  $\square$

We now strengthen Lemma 6 by showing that establishing whether an  $(n, k, r)$ -network is valid or not only requires to check the Cut Criterion for some special sets of vertices, called *essential*. Let  $N$  be an  $(n, k, r)$ -network and let  $X$  be a set of  $S$ -switches, and denote by  $\mathcal{B}(X)$  the set of blocks adjacent to  $X$ . A set  $W$  of vertices of  $N$  is *essential* if there exists a proper subset  $X$  of  $S$  (i.e.  $X \neq \emptyset$  and  $X \neq S$ ) such that  $W = X \cup \bigcup_{B \in \mathcal{B}(X)} B$  and  $W$  is connected.

**Lemma 7** An  $(n, k, r)$ -network is valid if and only if every essential set of vertices has non-negative excess.

**Proof** Since an essential set is connected, by Lemma 6, if an  $(n, k, r)$ -network is valid, then all its essential sets of vertices have non-negative excess.

Let us now prove the opposite. We need the following claim:

**Claim 7.1** *Let  $W$  be a set of vertices of an  $(n, k, r)$ -network. If  $W$  is adjacent to a vertex  $v \notin W$  such that  $\deg(v) \leq \text{in}(v) - \text{out}(v) + 2$ , then  $\text{exc}(W \cup \{v\}) \leq \text{exc}(W)$ .*

*Proof.* Since there is an edge between  $v$  and  $w$ , we have  $\deg(W \cup \{v\}) \leq \deg(W) + \deg(v) - 2$ . By definitions,  $\text{in}(W \cup \{v\}) = \text{in}(W) + \text{in}(v)$  and  $\text{out}(W \cup \{v\}) = \text{out}(W) + \text{out}(v)$ . So  $\min\{\text{out}(W \cup \{v\}), k\} \geq \min\{\text{out}(W), k\}$ . Hence

$$\begin{aligned} \text{exc}(W \cup \{v\}) &= \deg(W \cup \{v\}) - \text{in}(W \cup \{v\}) + \text{out}(W \cup \{v\}) - \min\{\text{out}(W \cup \{v\}), k\} \\ &\leq \deg(W) + \deg(v) - 2 - \text{in}(W) - \text{in}(v) + \text{out}(W) + \text{out}(v) - \min\{\text{out}(W), k\} \\ &\leq \text{exc}(W) + \deg(v) - \text{in}(v) + \text{out}(v) - 2 \leq \text{exc}(W) \end{aligned}$$

◇

Let us now prove that, if every essential set has non-negative excess, then every connected subset has non-negative excess. Together with Lemma 6, this yields the result.

Let  $W$  be a connected subset. Let  $X$  be the set of  $S$ -switches in  $W$  and  $W' = X \cup \bigcup_{B \in \mathcal{B}(X)} B$ . Clearly,  $W'$  is essential,  $W \subset W'$  and every vertex in  $W' \setminus W$  is a block switch. Now every block switch  $v$  has  $r - 1$  inputs so  $\deg(v) \leq 2r - \text{in}(v) - \text{out}(v) = r + 1 - \text{out}(v) \leq \text{in}(v) - \text{out}(v) + 2$ . Hence applying Claim 7.1 for every vertex of  $W' \setminus W$  one after another, we get that  $\text{exc}(W) \geq \text{exc}(W') \geq 0$ . □

### 3 Upper bounds

In this section, we present two constructions that combine two valid networks with certain properties into a larger valid network.

#### 3.1 First construction

We distinguish two cases according to the parity of  $k$ .

##### 3.1.1 First construction for even $k$

Let  $k$  be even. For  $i = 1, 2$ , let  $N_i = (G_i, \text{in}_i, \text{out}_i)$  be an  $(n_i, k, r)$ -network with a set  $A_i = \{v_i^1, \dots, v_i^{k/2}\}$  of  $k/2$  switches having at least two outputs each (i.e.  $\text{out}_i(v_i^j) \geq 2$  for  $1 \leq j \leq k/2$ ). We construct the  $(n_1 + n_2, k, r)$ -network  $N_1 \oplus N_2 = (G, \text{in}, \text{out})$  from  $N_1$  and  $N_2$  as follows: we remove one output from each  $v_i^j$  ( $\text{out}(v_i^j) = \text{out}_i(v_i^j) - 1$ ), and we add a link between  $v_1^j$  and  $v_2^j$  for  $1 \leq j \leq k/2$ . Let  $M = \{v_1^j v_2^j : 1 \leq j \leq k/2\}$  be the set of added links.

The following theorem is an extension of Theorem 9 of [3].

**Theorem 8** *Let  $k$  be even. Let  $N_1$  be a valid  $(n_1, k, r)$ -network with  $s_1$  switches and let  $N_2$  be a valid  $(n_2, k, r)$ -network with  $s_2$  switches both containing at least  $k/2$  switches having at least two outputs each. Then,  $N_1 \oplus N_2$  is a valid  $(n_1 + n_2, k, r)$ -network with  $s_1 + s_2$  switches.*

**Proof** By construction,  $N_1 \oplus N_2$  has  $s_1 + s_2$  switches.

Let us now show that it is valid. By Lemma 3, we need to prove that any set  $W$  of switches of  $N$  has non-negative excess.

Let  $W$  be a set of switches, and for  $i = 1, 2$  set  $W_i = V(G_i) \cap W$ . Denote by  $e$  the number of links of  $M$  between  $W_1$  and  $W_2$ , and denote by  $e_1$  (resp.  $e_2$ ) the number of links of  $M$  between  $W_1$  (resp.  $W_2$ ) and the switches of  $N_2$  (resp.  $N_1$ ) not in  $W_2$  (resp.  $W_1$ ). See Figure 3.

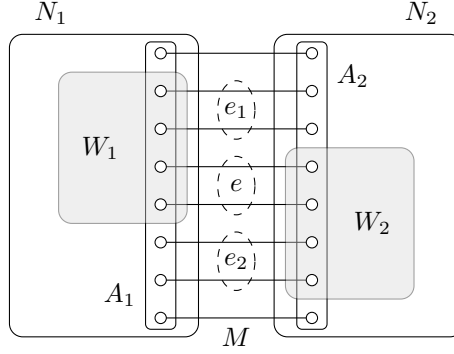

Figure 3: The first construction for even  $k$ .

By construction, we have:

$$\text{out}(W) = \text{out}_1(W_1) + \text{out}_2(W_2) - e_1 - e_2 - 2e; \quad (2)$$

$$\text{in}(W) = \text{in}_1(W_1) + \text{in}_2(W_2); \quad (3)$$

$$\text{deg}(W) = \text{deg}_1(W_1) + \text{deg}_2(W_2) + e_1 + e_2. \quad (4)$$

Since  $N_i$  is valid, the Cut Criterion yields

$$\text{deg}_i(W_i) \geq \text{in}_i(W_i) - \text{out}_i(W_i) + \min\{\text{out}_i(W_i), k\}$$

where  $\text{deg}_i(W_i)$  is the degree of  $W_i$  in  $N_i$ . We distinguish the following cases based on the value of  $\min\{\text{out}_i(W_i), k\}$ .

**Case 1.** Suppose that  $\text{out}_1(W_1) \geq k$  and  $\text{out}_2(W_2) \geq k$ . Hence by the Cut Criterion, for  $i = 1, 2$ ,  $\text{deg}_i(W_i) \geq \text{in}_i(W_i) + k - \text{out}_i(W_i)$  and so,

$$\text{deg}_1(W_1) + \text{deg}_2(W_2) \geq \text{in}_1(W_1) + \text{in}_2(W_2) + 2k - \text{out}_1(W_1) - \text{out}_2(W_2).$$

Hence, by (2), (3) and (4), we obtain

$$\text{deg}(W) \geq \text{in}(W) - \text{out}(W) + 2k - 2e \geq \text{in}(W) - \text{out}(W) + k.$$

**Case 2.** Suppose that  $\text{out}_1(W_1) < k$  and  $\text{out}_2(W_2) < k$ . For  $i = 1, 2$ , we have  $\text{deg}_i(W_i) \geq \text{in}_i(W_i)$ , so

$$\text{deg}_1(W_1) + \text{deg}_2(W_2) \geq \text{in}_1(W_1) + \text{in}_2(W_2).$$

So, by (3) and (4),  $\text{deg}(W) \geq \text{in}(W) \geq \text{in}(W) - \text{out}(W) + \min\{\text{out}(W), k\}$ .

**Case 3.** Suppose that  $\text{out}_1(W_1) < k$  and  $\text{out}_2(W_2) \geq k$ . Then,  $\text{deg}_1(W_1) \geq \text{in}_1(W_1)$  and  $\text{deg}_2(W_2) \geq \text{in}_2(W_2) + k - \text{out}_2(W_2)$ . So,

$$\text{deg}_1(W_1) + \text{deg}_2(W_2) \geq \text{in}_1(W_1) + \text{in}_2(W_2) + k - \text{out}_2(W_2).$$

By (2), (3), et (4), we obtain:

$$\text{deg}(W) \geq \text{in}(W) + k - \text{out}(W) + \text{out}_1(W_1) - 2e.$$

Moreover, by construction,  $\text{out}_1(W_1) \geq 2e$  since each vertex of  $W_1$  incident to an edge of  $M$  satisfies  $\text{out}_1 \geq 2$ . Hence,

$$\text{deg}(W) \geq \text{in}(W) - \text{out}(W) + k.$$

In all three cases,  $W$  satisfies the Cut Criterion.  $\square$



### 3.1.2 First construction for odd $k$

Let  $k = 2p + 1$  be odd. For  $i = 1, 2$ , let  $N_i = (G_i, \text{in}_i, \text{out}_i)$  be an  $(n_i, k, r)$ -network with a set  $A_i = \{v_i^1, \dots, v_i^p\}$  of  $p$  switches having at least two outputs each (i.e.  $\text{out}_i(v_i^j) \geq 2$  for  $1 \leq j \leq p$ ). Let  $w_1$  be a switch of  $V(G_1) \setminus A_1$  with an output ( $\text{out}_1(w_1) \geq 1$ ) or a vertex of  $A_1$  with at least 3 outputs ( $\text{out}_1(w_1) \geq 3$ ). Let  $z_2$  be the unique switch of  $N_2$  with  $2r - 1$  ports. We construct the  $(n_1 + n_2, k, r)$ -network  $N_1 \oplus N_2$  from  $N_1$  and  $N_2$  as follows: we remove on each  $v_i^j$  one output and we add a link between  $v_1^j$  and  $v_2^j$  for  $1 \leq j \leq k/2$ . Moreover we remove an output to  $w_1$  and connect  $w_1$  to  $z_2$ . See Figure 4.

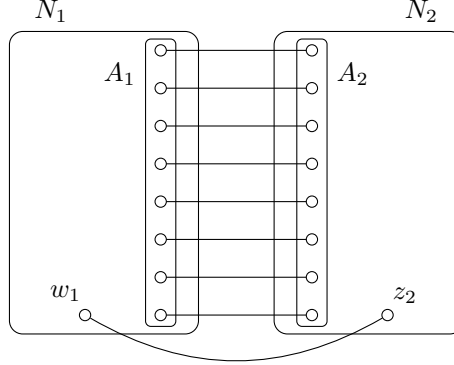

Figure 4: The first construction for odd  $k$ .

We will now prove an analogue to Theorem 8 for odd  $k$ . Therefore, we need the following well-known lemma:

**Lemma 9 (folklore)** *Let  $u$  and  $v$  be two vertices of a graph  $G$ . If  $u$  and  $v$  have both odd degree and all other vertices have even degree, then there is a path in  $G$  with endvertices  $u$  and  $v$ .*

**Theorem 10** *Let  $k = 2p + 1$  be odd. Let  $N_1$  be a valid  $(n_1, k, r)$ -network with  $s_1$  switches and let  $N_2$  be a valid  $(n_2, k, r)$ -network with  $s_2$  switches containing both at least  $p$  switches with at least two outputs. Then  $N_1 \oplus N_2$  is a valid  $(n_1 + n_2, k, r)$ -network containing  $s_1 + s_2$  switches.*

**Proof** By construction,  $N_1 \oplus N_2$  has  $s_1 + s_2$  switches.

Let us now show that it is valid. Let  $\text{out}'$  be a faulty output function such that  $\text{out}'(N_1 \oplus N_2) = n_1 + n_2$ .

Note that our construction is very close to the one of Theorem 8 and in most of the cases, the paths may be found by removing one output of  $N_1$  and one output of  $N_2$  to obtain two networks satisfying the conditions of Theorem 8.

In fact, one can see  $N_1$  as a valid  $(n_1, k - 1, r)$ -network, with one output less at  $w_1$ . Rigorously, the network  $M_1 = (G_1, \text{in}_1, \text{sor}_1)$ , defined by  $\text{sor}_1(v) = \text{out}_1(v)$  if  $v \in V(G_1) \setminus \{w_1\}$  and  $\text{sor}_1(w_1) = \text{out}_1(w_1) - 1$  otherwise, is a valid  $(n_1, k - 1, r)$ -network. Moreover, by the choice of  $w_1$ , every vertex  $v$  of  $A_1$  satisfies  $\text{sor}_1(v) \geq 2$ . For any vertex  $s_2$ , the  $(n_2, k - 1, r)$ -network  $M_2 = (G_2, \text{in}_2, \text{sor}_2)$ , defined by  $\text{sor}_2(v) = \text{out}_2(v)$  if  $v \in V(G_2) \setminus \{s_2\}$  and  $\text{sor}_2(s_2) = \text{out}_2(s_2) - 1$  otherwise, is valid. However, to apply Theorem 8 to  $M_1 \oplus M_2$ , we need the condition  $\text{sor}_2(v) \geq 2$  for all  $v \in A_2$ . This condition is only verified when  $s_2$  is not in  $A_2'$ , the set of vertices  $v$  of  $A_2$  such that  $\text{out}_2(v) = 2$ . Therefore, we distinguish two cases depending on whether there is a switch  $s_2$  of  $V(G_2) \setminus A_2'$  such that  $\text{out}'(s_2) < \text{out}(s_2)$ .

If there is a switch  $s_2$  of  $V(G_2) \setminus A_2'$  such that  $\text{out}'(s_2) < \text{out}(s_2)$ , then the networks  $M_1$  and  $M_2$  define above fulfill the conditions of Theorem 8, and so  $M_1 \oplus M_2$  is valid. Hence we can find  $n_1 + n_2$  edge-disjoint paths in  $M_1 \oplus M_2$  such that each vertex  $v \in V$  is the initial vertex of  $\text{in}(v)$  paths and the terminal vertex of  $\text{out}'(v)$  paths. Since the graph of  $M_1 \oplus M_2$  is the one of  $N_1 \oplus N_2$  minus the edge  $w_1 z_2$ , these paths are the desired ones in  $N_1 \oplus N_2$ .

Suppose now that every vertex  $v$  such that  $\text{out}'(v) < \text{out}(v)$  is in  $A'_2$ . Note that for such a  $v$ ,  $\text{out}'(v) = \text{out}(v) - 1 = 0$  because  $\text{out}(v) = \text{out}_2(v) - 1 = 1$ . The proof can be sketched as follows. We apply the validity of  $N_1$  and  $N_2$  to some well-chosen faulty output functions  $\text{out}'_1$  and  $\text{out}'_2$ . Doing so, we will obtain a set of  $n_1 + n_2$  edge-disjoint paths,  $n_1$  in  $N_1$  and  $n_2$  in  $N_2$ , which is very close to the desired one. The problems are the following: for some vertices of  $A_1$  and for  $w_1$ , the number of paths ending in the vertex exceeds by 1 its faulty output function, while for some vertices of  $A_2$  and for one specific vertex  $w_2 \in A_2$  (to be defined later), the faulty output function exceeds by 1 the number of paths ending in the vertex. Using the edges between vertices of  $A_1$  and  $A_2$ , we solve the problems at vertices in  $A_1$  and  $A_2$ . It then remains to find a path from  $w_1$  to  $w_2$  that is edge-disjoint from the previously constructed paths. This is done using Lemma 9. We now give the detailed proof.

Let  $p_2 = \text{out}(V(G_2)) - \text{out}'(V(G_2))$ ,  $J_2 = \{j, 1 \leq j \leq p \text{ and } \text{out}'(v_2^j) < \text{out}(v_2^j)\}$ . Clearly  $|J_2| = p_2$ . Set  $J_1 = \{1, 2, \dots, p\} \setminus J_2$ . Let us define  $\text{out}'_1$  by  $\text{out}'_1(v) = \text{out}'(v) + 1$  if  $v \in \{v_1^j, j \in J_1\} \cup \{w_1\}$  and  $\text{out}'_1(v) = \text{out}'(v)$  if  $v \in V(G_1) \setminus (\{v_1^j, j \in J_1\} \cup \{w_1\})$ . Let  $w_2$  be an arbitrary vertex of  $V(G_2) \setminus A'_2$  such that  $\text{out}_2(w_2) \geq 1$ . (Such a vertex exists as the total number of outputs in  $A_2$  is at most  $2k$ .) Let us define  $\text{out}'_2$  by  $\text{out}'_2(v) = \text{out}'(v) - 1$  if  $v \in \{v_2^j, j \in J_1 \setminus \{w_2\}\}$ ,  $\text{out}'_2(v) = \text{out}'(v)$  if  $v \in V(G_2) \setminus (\{v_2^j, j \in J_1\} \cup \{w_2\})$  and  $\text{out}'_2(w_2) = \text{out}(w_2) - 2$  if  $w_2 \in \{v_2^j, j \in J_1\}$  and  $\text{out}'_2(w_2) = \text{out}(w_2) - 1$  otherwise.

For  $i = 1, 2$ , the function  $\text{out}'_i$  is a faulty output function of  $N_i$ . Since  $N_i$  is valid, one can find a set  $\mathcal{P}_i$  of  $n_i$  edge-disjoint paths in  $N_i$  such that each vertex  $v \in V(G_i)$  is the initial vertex of  $\text{in}(v)$  paths and the terminal vertex of  $\text{out}'_i(v)$  paths.  $\mathcal{P}_1 \cup \mathcal{P}_2$  is almost the set of desired paths. The only problems are that each vertex of  $\{v_1^j, j \in J_1\} \cup \{w_1\}$  is the end of one path too many and each vertex of  $v \in \{v_2^j, j \in J_1\} \cup \{w_2\}$  is the end of one path too few. (If  $w_2 \in \{v_2^j, j \in J_1\}$ , then  $w_2$  is the end of two paths too few.) For any  $j \in J_1$ , let  $P_j$  be a path  $\mathcal{P}_1$  ending in  $v_1^j$  and  $Q_j = P_j v_1^j v_2^j$  and let  $P$  be a path of  $\mathcal{P}_1$  ending in  $w_1$ .

Consider the graph  $H_2$  obtained from  $G_2$  by removing all the edges of the paths in  $\mathcal{P}_2$ . Let us show that  $H_2$  has exactly two vertices with odd degree  $z_2$  and  $w_2$  unless  $z_2 = w_2$ . Let  $v$  be a vertex of  $V(G_2) \setminus \{w_2, z_2\}$ . If  $v \in \{v_2^j, j \in J_2\} \setminus \{z_2\}$ , then  $\text{out}_2(v) = 2$  and  $v$  is the end of no paths of  $\mathcal{P}_2$ . So the number  $e(v)$  of edges incident to  $v$  in paths of  $\mathcal{P}_2$  has the same parity as  $\text{in}_2(v)$ . Hence  $\deg_{H_2}(v) = 2r - \text{out}_2(v) - \text{in}_2(v) - e(v)$  is even. If  $v \in \{v_2^j, j \in J_1\}$ , then  $v$  is the end of  $\text{out}_2(v) - 2$  paths of  $\mathcal{P}_2$ . So the number  $e(v)$  of its incident edges in paths of  $\mathcal{P}_2$  has the same parity as  $\text{in}_2(v) + \text{out}_2(v)$ . Hence  $\deg_{H_2}(v)$  is even. If  $v \in V(G_2) \setminus A_2$ , then  $v$  is the end of  $\text{out}_2(v)$  and the start of  $\text{in}_2(v)$  paths of  $\mathcal{P}_2$ . Thus the number  $e(v)$  of edges incident to  $v$  in paths of  $\mathcal{P}_2$  has the same parity as  $\text{in}_2(v) + \text{out}_2(v)$ . It follows that  $\deg_{H_2}(v)$  is even. Analogously, one shows that the degrees of  $w_2$  and  $z_2$  in  $H_2$  are odd unless  $w_2 = z_2$ . Thus, by Lemma 9, there is a path  $Q$  from  $z_2$  to  $w_2$ . Now  $(\mathcal{P}_1 \cup \mathcal{P}_2) \setminus (\{P_j, j \in J_1\} \cup \{P\}) \cup (\{Q_j, j \in J_1\} \cup \{Q\})$  is the desired set of paths.  $\square$

### 3.1.3 Derived upper bound

Observe that if both  $N_1$  and  $N_2$  contains  $k$  switches with at least two outputs, then  $N_1 \oplus N_2$  contains also  $k$  such switches. In fact, in  $N_1$ ,  $k/2$  switches with two outputs lose one output to be linked to a switch of  $N_2$ . So at least  $k - k/2 = k/2$  switches of  $N_1$  have two outputs in  $N_1 \oplus N_2$ . Similarly, at least  $k/2$  switches of  $N_2$  have two outputs in  $N_1 \oplus N_2$ . Hence, in total,  $N_1 \oplus N_2$  contains at least  $k$  switches having at least two outputs each.

In particular, we can apply recursively Theorems 8 and 10 with  $N_1$ .

**Corollary 11** *Let  $k$  be an integer. Let  $N_1$  be a valid  $(n, k, r)$ -network with  $s$  switches,  $k$  of whom have at least two outputs. For any integer  $l$ ,  $N_l = N_1 \oplus N_{l-1}$  is a valid  $(ln, k, r)$ -network with  $l \cdot s$  switches.*

Havet [10] showed that  $\mathcal{N}(1, k, 2) = \lceil \frac{k}{2} \rceil$  and  $\mathcal{N}(2, k, 2) = \lceil \frac{k+2}{2} \rceil$ . Moreover there are optimum networks all switches of which have at least two outputs. We generalize these results for general  $r$ :

**Proposition 12**  $\mathcal{N}(1, k, r) = \lceil \frac{k}{2r-2} \rceil$  and  $\mathcal{N}(2, k, r) = \lceil \frac{k+2}{2r-2} \rceil$ . Moreover, there are optimum networks whose switches all have at least  $2r - 2$  outputs.

**Proof** Consider the network  $N_1$  (resp.  $N_2$ ) with  $s$  switches  $v_1, \dots, v_s$  such that  $v_1$  is a  $(0|2r-1)$ -switch (resp.  $(1|2r-2)$ -switch),  $v_s$  is a  $(1|2r-2)$ -switch, each  $v_i$ ,  $2 \leq i \leq s-1$ , is a  $(0|2r-2)$ -switch and  $(v_1, v_2, \dots, v_i)$  is a path. It is easy to check that  $N_1$  and  $N_2$  are a valid  $(1, (2r-2)s, r)$ -network and a valid  $(2, (2r-2)s-2, r)$ -network, respectively. It follows that  $\mathcal{N}(1, k, r) \leq \left\lceil \frac{k}{2r-2} \right\rceil$  and  $\mathcal{N}(2, k, r) \leq \left\lceil \frac{k+2}{2r-2} \right\rceil$  by Proposition 1.

Moreover, the above upper bounds are tight since a valid network must be connected.  $\square$

Corollary 11 and Proposition 12 yield:

**Corollary 13**

$$\text{If } n \text{ is even, } \quad \mathcal{N}(n, k, r) \leq \left\lceil \frac{k+2}{2r-2} \right\rceil \frac{n}{2}.$$

$$\text{If } n \text{ is odd, } \quad \mathcal{N}(n, k, r) \leq \left\lceil \frac{k+2}{2r-2} \right\rceil \frac{n-1}{2} + \left\lceil \frac{k}{2r-2} \right\rceil.$$

**3.2 Second construction**

Let  $k$  be an even integer and  $r \geq k/2$ . For  $i = 1, 2$ , let  $N_i = (G_i, \text{in}_i, \text{out}_i)$  be an  $(n_i, k, r)$ -network containing an  $(r - k/2|r)$ -switch  $u_i$ . We construct the  $(n_1 + n_2 - (r - k/2), k, r)$ -network  $N_1 \otimes N_2 = (G, \text{in}, \text{out})$  from  $N_1$  and  $N_2$  as follows: we identify  $u_1$  and  $u_2$  into a new vertex  $u^*$  and we set  $\text{in}(u^*) = \text{out}(u^*) = r - k/2$ . See Figure 5.

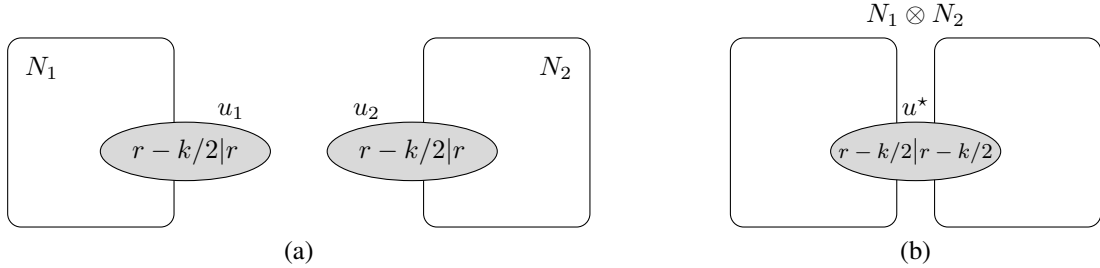

Figure 5: The second construction.

**Theorem 14** Let  $k$  be an even integer and  $r \geq k/2$ . Let  $N_1 = (G_1, \text{in}_1, \text{out}_1)$  be a valid  $(n_1, k, r)$ -network with  $s_1$  switches and let  $N_2 = (G_2, \text{in}_2, \text{out}_2)$  be a valid  $(n_2, k, r)$ -network with  $s_2$  switches both containing at least one  $(r - k/2|r)$ -switch. Then  $N_1 \otimes N_2 = (G, \text{in}, \text{out})$  is a valid  $(n_1 + n_2 - (r - k/2), k, r)$ -network containing  $s_1 + s_2 - 1$  switches.

**Proof** Let  $\text{out}'$  be a faulty output function on  $N_1 \otimes N_2$ . We shall exhibit a set  $\mathcal{P}$  of  $n_1 + n_2 - (r - k/2)$  edge-disjoint paths such that any vertex  $v$  of  $V(G)$  is the initial vertex of  $\text{in}(v)$  paths and the terminal vertex of  $\text{out}(v)$  paths. Let  $f_1$  be the number of faults on the vertices of  $V(G_1) \setminus \{u_1\}$  and  $f_2$  be the number of faults on the vertices of  $V(G_2) \setminus \{u_2\}$ . Let us define the faulty output function  $\text{out}'_1$  on  $N_1$  by  $\text{out}'_1(v) = \text{out}'(v)$  for any vertex  $v \in V(G_1) \setminus \{u_1\}$  and  $\text{out}'_1(u_1) = \text{out}(u_1) + f_2$ . Similarly, we define the faulty output function  $\text{out}'_2$  on  $N_2$  by  $\text{out}'_2(v) = \text{out}'(v)$  for any vertex  $v \in V(G_2) \setminus \{u_2\}$  and  $\text{out}'_2(u_2) = \text{out}(u_2) + f_1$ . Since for  $i = 1, 2$ ,  $N_i$  is valid, there exists a set  $\mathcal{P}_i$  of edge-disjoint paths such that any vertex  $v \in V(G_i)$  is the initial vertex of  $\text{in}_i(v)$  paths and the terminal vertex of  $\text{out}_i(v)$  paths. The set  $\mathcal{P} = \mathcal{P}_1 \cup \mathcal{P}_2$  is almost the desired set. The vertex  $u^*$  is the terminal vertex of  $r - k/2$  paths too many and the initial vertex of  $r - k/2$  paths too many. It suffices now to merge one to one  $r - k/2$  paths ending at  $u^*$  with as many paths beginning at  $u^*$  to obtain the desired set of paths.  $\square$

If  $N$  contains two  $(r - k/2|r)$ -switches, then  $N \otimes N$  contains also two such switches and we can apply recursively Theorem 14.

**Corollary 15** Let  $k$  be an integer. Let  $N_1$  be a valid  $(n, k, r)$ -network with  $s$  switches containing two  $(r - k/2|r)$ -switches. For any integer  $l \geq 2$ ,  $N_l = N_1 \otimes N_{l-1}$  is a valid  $(ln - (l-1)(r - k/2), k, r)$ -network with  $ls - (l-1)$  switches.

**Corollary 16** If  $r > \lceil k/2 \rceil$  then

$$\mathcal{N}(n, k, r) \leq \left\lceil \frac{n}{r - \lceil k/2 \rceil} \right\rceil.$$

**Proof** By Proposition 1, it suffices to prove the result for even  $k$ .

Suppose  $r > k/2$  and  $k$  is even, the  $(2r - k, k, r)$ -network consisting of two  $(r - k/2|r)$ -switches joined by  $k/2$  edges is trivially valid. Hence, by Corollary 15,  $\mathcal{N}(n, k, r) \leq \left\lceil \frac{n}{r - k/2} \right\rceil$ .  $\square$

However this upper bound may be improved for  $k \geq 3$  using better initial network.

**Theorem 17** For  $k \geq 3$  and  $r \geq \max\{3, k/2\}$ ,

$$\mathcal{N}(n, k, r) \leq \frac{r - 2 + \lceil k/2 \rceil}{r^2 - 2r + \lceil k/2 \rceil} n + O(1).$$

**Proof** By Proposition 1, it suffices to prove the result for even  $k$ .

Let  $H$  be the  $(r^2 - r, k, r)$ -network depicted in Figure 6 with  $r \geq k/2$ . It is composed of  $r - 1 + k/2$  switches:

- $k/2$  switches  $b_1, \dots, b_{k/2}$  of type  $r - 1|2$ , and
- $r - 1$  switches  $s_1, \dots, s_{r-1}$  of type  $r - k/2|r$ .

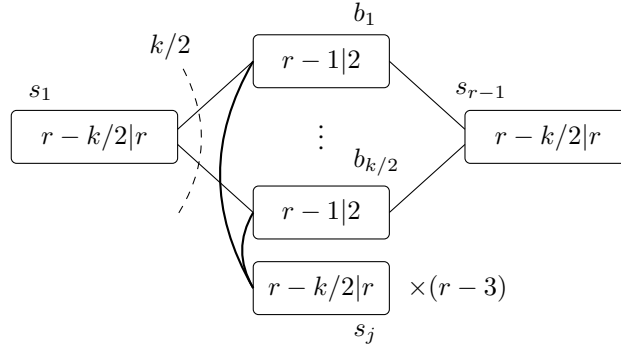

Figure 6: An  $(r^2 - r, k, r)$ -network with  $k \geq 2$  and  $r \geq \max\{3, k/2\}$ .

Each  $s_j$  is connected to all  $b_j$ .

Using Lemma 7, it is easy to check the validity of the network  $H$ . Let  $W$  be an essential set of vertices. Let  $S_W$  be the set of  $(r - k/2|r)$ -switches contained in  $W$ . Suppose that  $|S_W| = j$  ( $1 \leq j \leq r - 2$ ). By the observation made in the proof of Lemma 7, we can assume that  $W$  contains all  $b_i$  for  $1 \leq i \leq k/2$ . Now,  $\text{exc}(W) = \text{deg}(W) - \text{in}(W) + \text{out}(W) - \min\{\text{out}(W), k\} = (r - 1 - j)k/2 - ((r - k/2)j + (r - 1)k/2) + j \cdot r + k/2 \cdot 2 - \min\{\text{out}(w), k\} = k - \min\{\text{out}(W), k\} \geq 0$ . Hence, the network  $H$  is valid.

Corollary 15 applied to  $N_1 = H$  shows that the  $(n, k, r)$ -network depicted in Figure 7 is valid. Proposition 17 follows.  $\square$

**Remark 18** Theorem 17 does not hold for  $r = 2$ . The construction does not work since  $H$  has only one  $(r - k/2|r)$ -switch, and so  $H \otimes H$  has none. Bermond et al. [5] showed that  $\mathcal{N}(n, 6, 2) = \frac{5n}{4} + \sqrt{\frac{n}{8}} + \theta(1)$ .

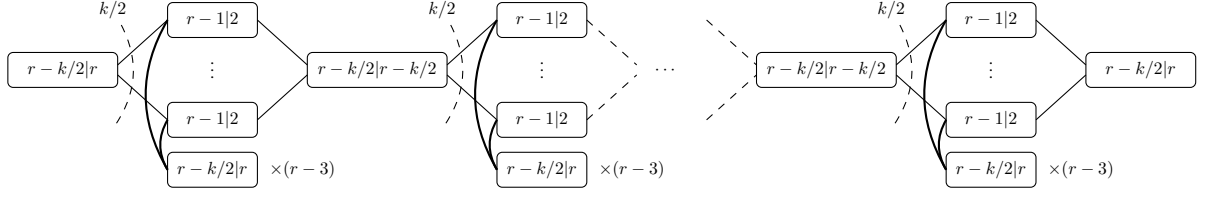

Figure 7: An  $(n, k, r)$ -network with  $k \geq 2$  and  $r \geq \max\{3, k/2\}$ .

## 4 Lower bounds

### 4.1 General lower bound

**Theorem 19** *If  $k \geq r$ , then  $\mathcal{N}(n, k, r) \geq \frac{3n + k}{2r}$ .*

**Proof** Let  $N = (G, \text{in}, \text{out})$  be a valid  $(n, k, r)$ -network with  $s$  switches. For any switch  $v$ ,  $\deg(v) \leq 2r - \text{in}(v) - \text{out}(v)$ . By Proposition 4, a switch has at most  $r$  outputs, so at most  $k$  outputs. Thus, by the Cut Criterion,  $\deg(v) \geq \text{in}(v)$ . Combining these two inequalities, we obtain  $2r \geq 2\text{in}(v) + \text{out}(v)$ . Summing such inequalities over all switches  $v$ , we obtain  $2r \cdot s \geq 3n + k$ . Hence  $s \geq \frac{3n+k}{2r}$ .  $\square$

In the remaining of this subsection, we prove a better upper bound on  $\mathcal{N}(n, k, r)$ , when  $k \geq 2r$ . Some preliminaries are required.

Let  $G = (V, E)$  be a graph and  $p$  is a positive integer: A  $p$ -quasi-partition of  $G$  is a set  $\{A_1, A_2, \dots, A_m\}$  of subsets of  $V$ , such that:

1. For every  $1 \leq i \leq m$ , the subgraph induced by  $A_i$ ,  $G[A_i]$ , is connected;
2. For every  $1 \leq i \leq m$ ,  $p/2 \leq |A_i| \leq p$ ;
3.  $V = \bigcup_{i=1}^m A_i$  and  $\sum_{i=1}^m |A_i| \leq |V| + |\{A_i, |A_i| \geq \frac{2p}{3} + 1\}| + p/6$ .

**Lemma 20** *Let  $p$  be a positive integer and let  $G$  be a connected graph of order at least  $p/2$ . Then  $G$  admits a  $p$ -quasi-partition.*

**Proof** Every connected graph  $G$  has a spanning tree  $T$ , and a  $p$ -quasi-partition of  $T$  is clearly a  $p$ -quasi-partition of  $G$ . Hence, it suffices to prove the result for the tree  $T$ . If  $p \leq 2$ , then the result is trivial, because the family of singleton  $\{v\}$ ,  $v \in V(T)$ , is a  $p$ -quasi-partition. Henceforth, we assume that  $p \geq 2$ . We prove it by induction on  $|V(T)|$  the result being trivial if  $|V(T)| \leq p$ .

For any positive real number  $q$ , let  $E_q$  be the set of edges of  $T$  such that each of the two components of  $T \setminus e$  has at least  $q$  vertices.

#### Claim 20.1

- (i) *If  $E_q \neq \emptyset$ , then the subgraph  $H_q$  induced by the edges of  $E_q$  is a subtree of  $T$ .*
- (ii) *If  $E_q = \emptyset$ , then there exists a vertex  $x$  such that all components of  $T - x$  have less than  $q$  vertices.*

*Proof.* (i) Let  $e_1$  and  $e_2$  be two edges of  $E_q$ . Since  $T$  is a tree, there is a unique path  $(x_1, \dots, x_p)$  in  $T$  such that  $x_1x_2 = e_1$  and  $x_{p-1}x_p = e_2$ . The forest  $T \setminus e_1$  has one component  $C_1$  containing  $x_1$  and one component containing  $x_2$  (and thus all the  $x_i$ ,  $i \geq 3$ ). Similarly,  $T \setminus e_2$  has one component  $C_2$  containing  $x_p$  and one component containing  $x_{p-1}$ . Since  $e_1$  and  $e_2$  are in  $E_q$ , both  $C_1$  and  $C_2$  have at least  $q$  vertices. Now for every  $2 \leq i \leq p-2$ ,  $T \setminus x_i x_{i+1}$  has one component  $C'_1$  containing  $x_i$  and another  $C'_2$  containing  $x_{i+1}$ . Clearly  $C'_1$  contains  $C_1$  because the path  $(x_1, \dots, x_i)$  is in  $C'_1$ . Similarly,  $C'_2$  contains  $C_2$ . Hence both  $C'_1$  and  $C'_2$  have at least  $q$  vertices, and so  $x_i x_{i+1} \in E_q$ .

Hence, the subgraph  $H_q$  is connected and thus is a tree.

(ii) Let us orient the edges of  $T$  as follows. Let  $e = uv$  be an edge of  $T$ . Because  $E_q$  is empty, we have  $e \notin E_q$ . Thus, at least one component of  $T \setminus e$  has size less than  $q$ . Without loss of generality, this component is the one containing  $v$ . Orient the edge  $e$  from  $u$  to  $v$ . Now every orientation of a tree contains a vertex  $x$  with outdegree 0. Consider a component  $C$  of  $T - x$ . It contains exactly one neighbour  $y$  of  $x$ , and it is precisely the component of  $T \setminus xy$  containing  $y$ . Thus  $|C| < q$  because the edge is oriented from  $x$  to  $y$ . Hence all components of  $T - x$  have less than  $q$  vertices.  $\diamond$

In view of Claim 20.1, we define the  $q$ -heart of  $T$ , denoted  $H_q$ , as follows: if  $E_q$  is not empty, then  $H_q$  is the subtree induced by the edges of  $E_q$ ; if  $E_q$  is empty, then  $H_q$  is a tree reduced to a vertex  $x$  such that all components of  $T - x$  have less than  $q$  vertices. (Note that if  $E_q$  is empty, then the  $q$ -heart is not uniquely defined, but any  $x$  having the given property is fine.)

Assume that  $p \leq |T| \leq 3p/2$ . Set  $t = |T|$ . If  $E_{p/2}$  contains an edge  $uv$ , then let  $C_u$  (resp.  $C_v$ ) be the component of  $T \setminus uv$  containing  $u$  (resp.  $v$ ). We have  $|C_u| + |C_v| = |T|$  and  $|C_u|, |C_v| \geq p/2$ . Thus,  $|C_u| \leq |T| - p/2 \leq p$  and similarly  $|C_v| \leq p$ . Hence  $(V(C_u), V(C_v))$  is a  $p$ -quasi-partition of  $T$ .

Suppose now that the  $p/2$ -heart  $H_{p/2}$  is reduced to a single vertex  $x$ . Let  $C_i$ ,  $1 \leq i \leq l$ , be the components of  $T - x$  indexed in decreasing order of their size:  $|C_1| \geq |C_2| \geq \dots \geq |C_l|$ . Let  $i$  be the smallest integer such that  $\sum_{j=1}^i |C_j| \geq (t-2)/3$ . Set  $A_1 = \bigcup_{j=1}^i C_j \cup x$ . Since the components are indexed in decreasing order of their size, then  $|A_1| \leq 2t/3$ . Thus  $B = V(T) \setminus A_1$  contains at least  $t/3$  vertices. Let  $T_2$  be a subtree of  $T[A_1]$  on  $\max\{p/2 - |B|, 1\}$  vertices containing  $x$ . Such a tree exists since  $|A_1| \geq t/3 \geq t/6 \geq p/2 - |B|$ . Now  $(A_1, V(T_2) \cup B)$  is a  $p$ -quasi-partition of  $T$ .

Assume now that  $T$  has more than  $3p/2$  vertices. Let  $u$  be a leaf of  $H_p$ . Let  $C_i$ ,  $1 \leq i \leq l$ , be the components of  $T - H_p$  which are connected to  $u$ . By definition of  $H_p$ , each of the  $C_i$  has less than  $p$  vertices and  $\sum |C_i| + 1 \geq p$ . Without loss of generality, we may assume that the  $C_i$  are indexed in decreasing order of their size:  $|C_1| \geq |C_2| \geq \dots \geq |C_l|$ . We shall distinguish two cases.

- Assume first that  $|C_1| \geq p/2$  vertices. The tree  $T - C_1$  has at least  $p/2$  vertices. Hence, by the induction hypothesis,  $T - C_1$  has a  $p$ -quasi-partition  $\{A_1, A_2, \dots, A_m\}$ . Setting  $A_{m+1} = V(C_1)$ , then one verifies easily that  $\{A_1, A_2, \dots, A_m, A_{m+1}\}$  is a  $p$ -quasi-partition of  $T$  since  $(T - C_1) \cap C_1 = \emptyset$ .
- Assume now that  $|C_1| < p/2$ . (In particular,  $p \geq 3$  and  $2p/3 + 1 \leq p$ ). Let  $i$  be the smallest integer such that  $\sum_{j=1}^i |C_j| \geq 2p/3$ . Since the components are indexed in decreasing order of their size, then  $\sum_{j=1}^i |C_j| < p$ . The tree  $T' = T - \bigcup_{j=1}^i V(C_j)$  has at least  $p/2$  vertices. Hence, by the induction hypothesis,  $T'$  has a  $p$ -quasi-partition  $\{A_1, A_2, \dots, A_m\}$ . Now setting  $A_{m+1} = \bigcup_{j=1}^i V(C_j) \cup \{u\}$ , one checks easily that  $\{A_1, A_2, \dots, A_m, A_{m+1}\}$  is a  $p$ -quasi-partition of  $T$  since  $T' \cap A_{m+1} = \{u\}$ .

$\square$

**Theorem 21** *If  $k \geq 2r$ , then  $\mathcal{N}(n, k, r) \geq \frac{3n + 2k/3 - r/2}{2r - 2 + \frac{3r}{\lfloor \frac{k}{r} \rfloor}}$ .*

**Proof** Let  $N = (G, \text{in}, \text{out})$  be a valid  $(n, k, r)$ -network with  $s$  switches. Set  $p = \lfloor \frac{k}{r} \rfloor$ . Since  $k \geq 2r$ , we have  $p \geq 2$ . Since all outputs are on switches,  $s \geq k/2r \geq p/2$ . So by Lemma 20,  $G$  admits a  $p$ -quasi-partition  $\{A_1, A_2, \dots, A_m\}$ . Let  $m_1 = |\{A_i, |A_i| \leq \frac{2p}{3}\}|$  and  $m_2 = |\{A_i, |A_i| > \frac{2p}{3}\}|$ . By definition of  $p$ -quasi-partition, we have

$$s \geq \sum_{i=1}^m |A_i| - m_2 - \frac{p}{6} \geq \frac{p}{2} m_1 + \left(\frac{2p}{3} + 1\right) m_2 - m_2 - \frac{p}{6}.$$

Therefore

$$\frac{3r}{p} s \geq \frac{3r}{2} \cdot m_1 + 2r m_2 - \frac{r}{2} \geq 2m_1 + 2r m_2 - \frac{r}{2}. \quad (5)$$

For  $1 \leq i \leq m$ , let  $e_i$  be the number of edges joining two vertices of  $A_i$ . Since  $G[A_i]$  is connected, we have  $e_i \geq |A_i| - 1$ . Furthermore, because every input, output or edge is connected to a port of a switch,  $2r|A_i| \geq \text{in}(A_i) + \text{out}(A_i) + \text{deg}(A_i) + 2e_i$ , so  $\text{deg}(A_i) \leq 2(r-1)|A_i| + 2 - \text{in}(A_i) - \text{out}(A_i)$ . But, by Proposition 4, a switch has at most  $r$  outputs, so  $A_i$  has at most  $k$  outputs. Thus, by the Cut Criterion,  $\text{deg}(A_i) \geq \text{in}(A_i)$ . Combining the last two inequalities, we obtain  $2(r-1)|A_i| + 2 \geq 2\text{in}(A_i) + \text{out}(A_i)$ . Summing these inequalities over all  $i$ , we obtain

$$\begin{aligned} 2m + 2(r-1) \sum_{i=1}^m |A_i| &\geq 2 \sum_{i=1}^m \text{in}(A_i) + \sum_{i=1}^m \text{out}(A_i), \\ 2m + 2(r-1)(s + m_2 + p/6) &\geq 2\text{in}(G) + \text{out}(G), \text{ and} \\ 2m_1 + 2rm_2 + (2r-2)s &\geq 3n + k - (r-1)\frac{p}{3} \geq 3n + \frac{2k}{3}. \end{aligned} \quad (6)$$

Combining Eq.(6) and Eq.(5) we obtain  $\frac{3r}{p}s + (2r-2)s \geq 3n + \frac{2k}{3} - \frac{r}{2}$ , so  $s \geq \frac{3n + \frac{2k}{3} - \frac{r}{2}}{2r-2 + \frac{3r}{p}}$ .  $\square$

## 4.2 Optimal lower bounds for $k \leq 6$

Bermond, Pérennes and Tóth [5] proved:

- for  $k \in \{1, 2\}$ ,  $\mathcal{N}(n, k, 2) = n$ ,
- for  $k \in \{3, 4\}$ ,  $\mathcal{N}(n, k, 2) = \left\lceil \frac{5n}{4} \right\rceil$ , and
- for  $k \in \{5, 6\}$ ,  $\mathcal{N}(n, k, 2) = \frac{5n}{4} + \sqrt{\frac{n}{8}} + \Theta(1)$ .

We now present bounds for  $\mathcal{N}(n, k, r)$ , which are optimal up to an additive constant, for some cases where  $k \leq 6$  and  $r \geq 3$ .

By Proposition 4, in a minimum  $(n, k, r)$ -network, the number of inputs  $n$  is at most  $r-1$  times the number of switches.

$$\mathcal{N}(n, k, r) \geq \left\lceil \frac{n}{r-1} \right\rceil.$$

For  $k \in \{1, 2\}$ , this lower bound matches the upper one given by Corollary 16.

### Theorem 22

$$\mathcal{N}(n, 1, r) = \mathcal{N}(n, 2, r) = \left\lceil \frac{n}{r-1} \right\rceil.$$

For larger value of  $k$ , we need to look more precisely at the blocks and  $S$ -switches of the network. Let us introduce some notations.

Let  $0 \leq i \leq r-1$  and  $0 \leq o \leq 2$ . Denote by  $S_i$  the set of switches with  $i$  inputs and  $s_i$  its cardinality. In particular,  $S_{r-1}$  is the set of block switches, and the blocks are maximum connected subgraphs made of vertices of  $S_{r-1}$ . Denote  $\mathcal{B}_o$  the set of blocks with  $o$  outputs and  $b_o$  its cardinality. We call  $\mathcal{B}_o$ -block a block in  $\mathcal{B}_o$  and we denote by  $t_o$  the total number of switches in the  $\mathcal{B}_o$ -blocks. By Proposition 5, a block has at most two outputs, so the total number of block switches is  $s_{r-1} = t_0 + t_1 + t_2$ .

Let  $S$  be the set of  $S$ -switches, that is  $S = \bigcup_{i=0}^{r-2} S_i$ . Let  $s_{i|o}$  denote the number of  $(i|o)$ -switches,  $s_S$  the number of  $S$ -switches and  $e_S$  the number of edges joining two  $S$ -switches.

Finally,  $s$  denotes the total number of switches of the network.

Let  $N$  be a valid  $(n, k, r)$ -network. Set  $e'(N) = 1$  if an  $S$ -switch is defective,  $e'(N) = -1$  if a block switch is defective, and  $e'(N) = 0$  otherwise.

**Proposition 23** Let  $N$  be a minimum  $(n, k, r)$ -network.

$$s_S + t_0 + t_1 + t_2 = s; \quad (7)$$

$$\sum_{i=0}^{r-2} \sum_{o=0}^r i \cdot s_{i|o} + (r-1)(t_0 + t_1 + t_2) = n; \quad (8)$$

$$\sum_{i=0}^{r-2} \sum_{o=0}^r o \cdot s_{i|o} + b_1 + 2b_2 = n + k; \quad (9)$$

$$-\sum_{i=0}^{r-2} \sum_{o=0}^r (2r - i - o) s_{i|o} + (r-1)(t_0 + t_1 + t_2) + 2e_S + 2b_0 + b_1 = \epsilon'(N); \quad (10)$$

$$b_2 \leq t_2. \quad (11)$$

**Proof** Eq.(7), Eq.(8) and Eq.(9) count the number of switches, inputs and outputs, respectively, in the network.

Eq.(10) counts the number of edges between blocks and  $S$ -switches. The number of edges leaving the  $\mathcal{B}_0$ -blocks (resp.  $\mathcal{B}_1$ -blocks,  $\mathcal{B}_2$ -blocks) is  $(r-1)t_0 + 2b_0$  (resp.  $(r-1)t_1 + b_1$ ,  $(r-1)t_2$ ) decreased by 1 if a block switch is defective; the number of edges leaving  $S$  is  $\sum_{i=0}^{r-2} \sum_{o=0}^r (2r - i - o) s_{i|o} - 2e_S$  decreased by 1 if an  $S$ -switch is defective.

Eq.(11) expresses the fact that a  $\mathcal{B}_2$ -block contains at least one switch.  $\square$

**Proposition 24** For  $r \geq 3$  and  $k \geq 3$ ,

$$\mathcal{N}(n, k, r) \geq \left\lceil \frac{rn + \frac{1}{2}(k - \epsilon(k))}{r^2 - 2r + 2} \right\rceil.$$

**Proof**  $(r-2)s_S = (r-2) \sum_{(i,o)=(0,0)}^{r-2,r} i \cdot s_{i|o} \geq \sum_{(i,o)=(0,0)}^{r-2,r} i \cdot s_{i|o} \geq n - (r-1)(t_0 + t_1 + t_2)$ , by Eq. (9).

Hence,

$$s_S \geq \frac{n - (r-1)s_{r-1}}{(r-2)}. \quad (12)$$

Now, let us count the total number of ports of the  $S$ -switches :

$$\begin{aligned} 2rs_S &= \sum_{i=0}^{r-2} \sum_{o=0}^r (2r - i - o) s_{i|o} + \sum_{i=0}^{r-2} \sum_{o=0}^r i \cdot s_{i|o} + \sum_{i=0}^{r-2} \sum_{o=0}^r o \cdot s_{i|o} \\ &= (r-1)(t_0 + t_1 + t_2) + 2b_0 + b_1 + \sum_{i=0}^{r-2} \sum_{o=0}^r i \cdot s_{i|o} + \sum_{i=0}^{r-2} \sum_{o=0}^r o \cdot s_{i|o} && \text{by Eq. (10)} \\ &= n + 2b_0 + b_1 + \sum_{i=0}^{r-2} \sum_{o=0}^r o \cdot s_{i|o} - \epsilon'(N) && \text{by Eq. (8)} \\ &= n + 2b_0 + n + k - 2b_2 - \epsilon'(N) && \text{by Eq. (9)} \\ &\geq 2n + k - 2s_{r-1} - \epsilon'(N) && \text{by Eq. (11)} \end{aligned}$$

$$s_S \geq \frac{2n - 2s_{r-1} + k - \epsilon'(N)}{2r}. \quad (13)$$

The inequalities (12) and (13) give a lower bound of  $s = s_S + s_{r-1}$  :

$$s \geq \max \left\{ s_{r-1} + \frac{n - (r-1)s_{r-1}}{r-2}, s_{r-1} + \frac{2n - 2s_{r-1} + k - \epsilon'(N)}{2r} \right\}.$$

One of these two functions (of  $s_{r-1}$ ) increases while the other decreases, thus the minimum is achieved when the two bounds are equal that is when  $s_{r-1} = \frac{2n - \frac{1}{2}(r-2)(k - \epsilon'(N))}{r^2 - 2r + 2}$ . We obtain  $s \geq \frac{rn + \frac{1}{2}(k - \epsilon(k))}{r^2 - 2r + 2}$ .  $\square$

For  $k \in \{3, 4\}$ , the lower bound of this proposition matches the upper one given by Theorem 17.



**Corollary 25** For  $k \in \{3, 4\}$  and  $r \geq 3$ ,  $\mathcal{N}(n, k, r) = \frac{r}{r^2 - 2r + 2}n + \Theta(1)$ .

We now get better lower bounds provided that  $k \geq 5$ . We first provide new inequalities satisfied by a valid  $(n, k, r)$ -network if  $k \geq 5$ . Define  $\epsilon''(N) = 1$  if a switch having less than  $r - 2$  inputs is defective, and  $\epsilon''(N) = 0$  otherwise. Note that if  $k \geq 2$  a  $\mathcal{B}_2$ -block  $B$  does not contain any defective vertex for otherwise  $\deg(B) = \text{in}(B) - 1$ , and so  $\text{exc}(B) = -1$ , which is impossible by the Cut Criterion.

**Proposition 26** If  $k \geq 5$  and  $r \geq 4$ , a valid  $(n, k, r)$ -network  $N$  satisfies the following inequalities:

$$b_1 \leq t_1; \quad (14)$$

$$(2r + 2)s_{r-1} + (2r - 6)s_{r-2} - \sum_{j=0}^{r-3} 2j \cdot s_{r-3-j} + k \leq 6s. \quad (15)$$

**Proof** Eq.(14) expresses the fact that a  $\mathcal{B}_1$ -block contains at least one switch.

Let us now show Eq.(15). Let  $H = \mathcal{B}_0 \cup \mathcal{B}_1 \cup \mathcal{B}_2 \cup S_{r-2}$  and  $H' = H \setminus \mathcal{B}_2$ .

We have  $\text{out}(H) + \text{out}(\overline{H}) = \text{in}(H) + \text{in}(\overline{H}) + k$  so  $\text{out}(\overline{H}) - \text{in}(\overline{H}) = k + \text{in}(H) - \text{out}(H) = k + (r - 1)s_{r-1} - b_1 - 2b_2 + \sum_{o=0}^4 (r - 2 - o)s_{r-2|o}$ .

Let us now compute  $\deg(H) = \deg(\overline{H})$ . Since there is no edge between blocks,  $\deg(H) = \deg(H') + \sum_{B \in \mathcal{B}_2} \deg(B) - 2e$  with  $e$  the number of edges between  $\mathcal{B}_2$ -blocks and switches of  $S_{r-2}$ .

By the Cut Criterion,  $\deg(H') \geq \text{in}(H') - \text{out}(H') \geq (r - 1)(t_1 + t_0) - b_1 + \sum_{o=0}^4 (r - 2 - o)s_{r-2|o}$ .

A  $\mathcal{B}_2$ -block  $B$  is not adjacent to a switch  $v$  of type  $r - 2|3$  or  $r - 2|4$  for otherwise  $B \cup \{v\}$  has negative excess which is impossible. For  $0 \leq j \leq 2$ , let  $a_j$  be the number of links between  $\mathcal{B}_2$ -blocks and switches of  $S_{r-2}$  having  $j$  outputs. If  $j = 1, 2$ , a switch of type  $r - 2|j$  cannot be incident to two links incident to  $\mathcal{B}_2$ -blocks, for otherwise the union of this switch and the two  $\mathcal{B}_2$ -blocks connected to it has negative excess. Hence  $a_j \leq s_{r-2|j}$  for  $j = 1, 2$ . A switch of type  $r - 2|0$  cannot be incident to three links incident to  $\mathcal{B}_2$ -blocks, for otherwise the union of this switch and the three  $\mathcal{B}_2$ -blocks connected to it has negative excess. Hence  $2a_0 \leq s_{r-2|0}$ . Consequently,  $e = a_0 + a_1 + a_2 \leq s_{r-2|1} + s_{r-2|2} + 2s_{r-2|0}$ .

Hence we obtain:

$$\deg(\overline{H}) \geq (r - 1)(t_2 + t_1 + t_0) - b_1 + (r - 6)(s_{r-2|4} + s_{r-2|2} + s_{r-2|0}) + (r - 5)(s_{r-2|3} + s_{r-2|1}).$$

So

$$\begin{aligned} \deg(\overline{H}) + \text{out}(\overline{H}) - \text{in}(\overline{H}) &\geq k + 2(r - 1)s_{r-1} - 2b_1 - 2b_2 + (2r - 12)s_{r-2|4} \\ &\quad + (2r - 10)(s_{r-2|3} + s_{r-2|2}) + (2r - 8)(s_{r-2|1} + s_{r-2|0}). \end{aligned}$$

By (14)  $b_1 \leq t_1$ , and by (11)  $b_2 \leq t_2$ . Thus

$$\deg(\overline{H}) + \text{out}(\overline{H}) - \text{in}(\overline{H}) \geq k + 2(r - 2)s_{r-1} + (2r - 12)s_{r-2}. \quad (16)$$

Now  $\deg(\overline{H}) + \text{out}(\overline{H}) - \text{in}(\overline{H}) \leq \sum_{v \in \overline{H}} (\deg(v) + \text{out}(v) - \text{in}(v)) \leq \sum_{v \in \overline{H}} (2r - 2\text{in}(v))$ .

$$\deg(\overline{H}) + \text{out}(\overline{H}) - \text{in}(\overline{H}) \leq \sum_{j=0}^{r-3} (6 + 2j)s_{r-3-j}. \quad (17)$$

Combining (16) and (17), we obtain (15).  $\square$

**Proposition 27** For  $r \geq 7$  and  $k \geq 5$ ,

$$\mathcal{N}(n, k, r) \geq \frac{(r + 1)n + k}{r^2 - 2r + 3}.$$

**Proof** We have  $n - (r - 3)s = \sum_{i=0}^{r-1} (i - r + 3)s_i = 2s_{r-1} + s_{r-2} - \sum_{j=0}^{r-3} j \cdot s_{r-3-j}$ . Hence if  $r \geq 7$ , by (15), we obtain  $6s \geq k + (r + 1)(n - (r - 3)s)$ . So  $s \geq \frac{(r+1)n+k}{r^2-2r+3}$ .  $\square$

The lower bound of Proposition 27 matches the upper one given by Theorem 17 for  $k = \{5, 6\}$ .

**Corollary 28** For  $k \in \{5, 6\}$  and  $r \geq 7$ ,  $\mathcal{N}(n, k, r) = \frac{r + 1}{r^2 - 2r + 3}n + \Theta(1)$ .

We conjecture that Proposition 27 also holds for  $r \leq 7$ . Together with Theorem 17, this would yield the following conjecture.

**Conjecture 29** For  $k \in \{5, 6\}$  and  $r \geq 3$ ,  $\mathcal{N}(n, k, r) = \frac{r + 1}{r^2 - 2r + 3}n + \Theta(1)$ .

## References

- [1] G. B. Adams III, D. P. Agrawal, and H. J. Siegel. A survey and comparison of fault-tolerant multistage interconnection networks. *Computer* 20 (1987), 14–27.
- [2] B. Beauquier and E. Darrot. On Arbitrary Size Waksman Networks and their Vulnerability. *Parallel Processing Letters* 12 (2002), 287–296.
- [3] J.-C. Bermond, E. Darrot, and O. Delmas. Design of Fault-Tolerant Networks for Satellites (TWTA Redundancy). *Networks* 40 (2002), 202–207.
- [4] J.-C. Bermond, F. Havet, and D. Tóth. Fault tolerant on board networks with priorities. *Networks* 47 (2006), 9–25.
- [5] J.-C. Bermond, S. Pérennes, and D. Tóth. Design of fault tolerant flow networks. Manuscript 2001, <http://www-sop.inria.fr/members/Stephane.Perennes/toth.pdf>
- [6] E. Darrot. Diffusion de messages longs et propriétés structurelles dans les réseaux d’interconnexion. PhD thesis, Université de Nice - Sophia Antipolis, France, June 1997.
- [7] J. Duato, S. Yalamanchili, and L. Ni. *Interconnection Networks An Engineering Approach*. Computer Science, Mathematics Electrical Engineering, Elsevier, 2003.
- [8] K.Y. Eng and M. Hecht. Switch matrix for TWTA redundancy an communication satellites. Record of the IEEE 1978 National Telecommunications Conference, Birmingham, AL, USA, December 1978, pp. 185–191,
- [9] L.R. Ford and D.R. Fulkerson. *Flows in Networks*. Princeton University Press, 1962. sixth printing, 1974.
- [10] F. Havet. Repartitors, selectors and superselectors. *Journal of Interconnection Networks* 7 (2006), 391–415.
- [11] F. T. Leighton. *Introduction to Parallel Algorithms and Architectures: Arrays · Trees · Hypercubes*. Computer Science, Mathematics Electrical Engineering. Morgan Kaufmann Publishers, 1992.
- [12] D. Roddy. *Satellite Communications*. McGraw-Hill Professional, ISBN 0071462988, 2006.