

Inversion number of an oriented graph and related parameters

Jørgen Bang-Jensen, Jonas Ferreira da Silva, Frédéric Havet

► **To cite this version:**

Jørgen Bang-Jensen, Jonas Ferreira da Silva, Frédéric Havet. Inversion number of an oriented graph and related parameters. ALGOS 2020 - 1st International Conference on Algebras, Graphs and Ordered Sets, Aug 2020, Nancy / Virtual, France. hal-03035419

HAL Id: hal-03035419

<https://hal.inria.fr/hal-03035419>

Submitted on 2 Dec 2020

HAL is a multi-disciplinary open access archive for the deposit and dissemination of scientific research documents, whether they are published or not. The documents may come from teaching and research institutions in France or abroad, or from public or private research centers.

L'archive ouverte pluridisciplinaire **HAL**, est destinée au dépôt et à la diffusion de documents scientifiques de niveau recherche, publiés ou non, émanant des établissements d'enseignement et de recherche français ou étrangers, des laboratoires publics ou privés.

INVERSION NUMBER OF AN ORIENTED GRAPH AND RELATED PARAMETERS

Jørgen Bang-Jensen

Department of Mathematics and Computer Science,
University of Southern Denmark
Odense, Denmark
jbj@imada.sdu.dk

Jonas Costa Ferreira da Silva

Department of Computer Science
Universidade Federal do Ceará
Fortaleza, Brazil
jonascosta@lia.ufc.br

Frédéric Havet

Université Côte d'Azur, CNRS, Inria, I3S,
Sophia Antipolis, France
frederic.havet@inria.fr

ABSTRACT

Let D be an oriented graph. The **inversion** of a set X of vertices in D consists in reversing the direction of all arcs with both ends in X . The **inversion number** of D , denoted by $\text{inv}(D)$, is the minimum number of inversions needed to make D acyclic. Denoting by $\tau(D)$, $\tau'(D)$, and $\nu(D)$ the cycle transversal number, the cycle arc-transversal number and the cycle packing number of D respectively, one shows that $\text{inv}(D) \leq \tau'(D)$, $\text{inv}(D) \leq 2\tau(D)$ and there exists a function g such that $\text{inv}(D) \leq g(\nu(D))$. We conjecture that for any two oriented graphs L and R , $\text{inv}(L \rightarrow R) = \text{inv}(L) + \text{inv}(R)$ where $L \rightarrow R$ is the dijoin of L and R . This would imply that the first two inequalities are tight. We prove this conjecture when $\text{inv}(L) \leq 1$ and $\text{inv}(R) \leq 2$ and when $\text{inv}(L) = \text{inv}(R) = 2$ and L and R are strongly connected. We also show that the function g of the third inequality satisfies $g(1) \leq 4$.

We then consider the complexity of deciding whether $\text{inv}(D) \leq k$ for a given oriented graph D . We show that it is NP-complete for $k = 1$, which together with the above conjecture would imply that it is NP-complete for every k . This contrasts with a result of Belkhechine et al. [6] which states that deciding whether $\text{inv}(T) \leq k$ for a given tournament T is polynomial-time solvable.

Keywords Feedback vertex set · Feedback arc set · Inversion · Tournament · Oriented graph · Intercyclic digraph.

1 Introduction

Notation not given below is consistent with [2]. Making a digraph acyclic by either removing a minimum cardinality set of arcs or vertices are important and heavily studied problems, known under the names CYCLE ARC TRANSVERSAL or FEEDBACK ARC SET and CYCLE TRANSVERSAL or FEEDBACK VERTEX SET. A **cycle transversal** or **feedback vertex set** (resp. **cycle arc-transversal** or **feedback arc set**) in a digraph is a set of vertices (resp. arcs) whose deletion results in an acyclic digraph. The **cycle transversal number** (resp. **cycle arc-transversal number**) is the minimum size of a cycle transversal (resp. cycle arc-transversal) of D and is denoted by $\tau(D)$ (resp. $\tau'(D)$). Note that if F is a minimum cycle arc-transversal in a digraph $D = (V, A)$, then we will obtain an acyclic digraph from D by either removing the arcs of F or reversing each of these, that is replacing each arc $uv \in F$ by the arc vu . It is well-known and easy to show that $\tau(D) \leq \tau'(D)$ (just take one end-vertex of each arc in a minimum cycle arc-transversal).

Computing $\tau(D)$ and $\tau'(D)$ are two of the first problems shown to be NP-hard listed by Karp in [9]. They also remains NP-complete in tournaments as shown by Bang-Jensen and Thomassen [4] and Speckenmeyer [14] for τ , and by Alon [1] and Charbit, Thomassé, and Yeo [7].

In this paper, we consider another operation, called **inversion**, where we reverse all arcs of an induced subdigraph. Let D be a digraph. The **inversion** of a set X of vertices consists in reversing the direction of all arcs of $D(X)$. We say that we **invert** X in D . The resulting digraph is denoted by $\text{Inv}(D; X)$. If $(X_i)_{i \in I}$ is a family of subsets of $V(D)$, then $\text{Inv}(D; (X_i)_{i \in I})$ is the digraph obtained after inverting the X_i one after another. Observe that this is independent of the order in which we invert the X_i : $\text{Inv}(D; (X_i)_{i \in I})$ is obtained from D by reversing the arcs such that an odd number of the X_i contain its two end-vertices.

Since an inversion preserves the directed cycles of length 2, a digraph can be made acyclic only if it has no directed cycle of length 2, that is if it is an **oriented graph**. Reciprocally, observe that in an oriented graph, reversing an arc $a = uv$ is the same as inverting $X_a = \{u, v\}$. Hence if F is a cycle arc-transversal of D , then $\text{Inv}(D; (X_a)_{a \in F})$ is acyclic.

A **decycling family** of an oriented graph D is a family of subsets $(X_i)_{i \in I}$ of subsets of $V(D)$ such that $\text{Inv}(D; (X_i)_{i \in I})$ is acyclic. The **inversion number** of an oriented graph D , denoted by $\text{inv}(D)$, is the minimum number of inversions needed to transform D into an acyclic digraph, that is, the minimum cardinality of a decycling family. By convention, the empty digraph (no vertices) is acyclic and so has inversion number 0.

1.1 Inversion versus cycle (arc-) transversal and cycle packing

One can easily obtain the following upper bounds on the inversion number in terms of the cycle transversal number and the cycle arc-transversal number. See Section 2.

Theorem 1.1. $\text{inv}(D) \leq \tau'(D)$ and $\text{inv}(D) \leq 2\tau(D)$ for all oriented graph D .

A natural question is to ask whether these bounds are tight or not.

We denote by \vec{C}_3 the directed cycle of length 3 and by TT_n the transitive tournament of order n . The vertices of TT_n are v_1, \dots, v_n and its arcs $\{v_i v_j \mid i < j\}$. The **lexicographic product** of a digraph D by a digraph H is the digraph $D[H]$ with vertex set $V(D) \times V(H)$ and arc set $A(D[H]) = \{(a, x)(b, y) \mid ab \in A(D), \text{ or } a = b \text{ and } xy \in A(H)\}$. It can be seen as blowing up each vertex of D by a copy of H . Using boolean dimension, Belkhechine et al. [5] proved the following.

Theorem 1.2 (Belkhechine et al. [5]). $\text{inv}(TT_n[\vec{C}_3]) = n$.

Since $\tau'(TT_n[\vec{C}_3]) = n$, this shows that the inequality $\text{inv}(D) \leq \tau'(D)$ of Theorem 1.1 is tight.

Pouzet asked for an elementary proof of Theorem 1.2. Let L and R be two digraphs. The **dijoin** from L to R is the digraph, denoted by $L \rightarrow R$, obtained from the disjoint union of L and R by adding all arcs from L to R . Observe that $TT_n[\vec{C}_3] = \vec{C}_3 \rightarrow TT_{n-1}[\vec{C}_3]$. So a way to elementary prove Theorem 1.2 would be to prove that $\text{inv}(\vec{C}_3 \rightarrow T) = \text{inv}(T) + 1$ for all tournament T . In fact, we believe that the following more general statement holds.

Conjecture 1.3. For any two oriented graphs L and R , $\text{inv}(L \rightarrow R) = \text{inv}(L) + \text{inv}(R)$.

As observed in Proposition 2.5, this conjecture is equivalent to its restriction to tournaments. If $\text{inv}(L) = 0$ (resp. $\text{inv}(R) = 0$), then Conjecture 1.3 holds has any decycling family of R (resp. L) is also a decycling family of $L \rightarrow R$. In Section 3, we prove Conjecture 1.3 when $\text{inv}(L) = 1$ and $\text{inv}(R) \in \{1, 2\}$. We also prove it when $\text{inv}(L) = \text{inv}(R) = 2$ and both L and R are strongly connected.

Let us now consider the inequality $\text{inv}(D) \leq 2\tau(D)$ of Theorem 1.1. One can see that is tight for $\tau(D) = 1$, that is $h(1) = 2$. Indeed, let V_n be the tournament obtained from a TT_{n-1} by adding a vertex x such that $N^+(v_i) = \{v_i \mid i \text{ is odd}\}$ (and so $N^-(v_i) = \{v_i \mid i \text{ is even}\}$). Clearly, $\tau(V_n) = 1$ because $V_n - x$ is acyclic, and one can easily check that $\text{inv}(V_n) \geq 2$ for $n \geq 5$. Observe that V_5 is strong, so by the above results, we have $\text{inv}(V_5 \rightarrow V_5) = 4$ while $\tau(V_5 \rightarrow V_5) = 2$, so $h(2) = 4$. More generally, Conjecture 1.3 would imply that $\text{inv}(TT_n[V_5]) = 2n$, while $\tau(TT_n[V_5])$ and thus that the inequality (ii) of Theorem 1.1 is tight. Hence we conjecture the following.

Conjecture 1.4. $h(n) = 2n$ for all positive integer n . In other words, for every positive integer n , there exists a digraph D such that $\tau(D) = n$ and $\text{inv}(D) = 2n$.

A **cycle packing** in a digraph is a set of vertex disjoint cycles. The **cycle packing number** of a digraph D , denoted by $\nu(D)$, is the maximum size of a cycle packing in D . We have $\nu(D) \leq \tau(D)$ for every digraph D . On the other hand, Reed et al. [12] proved that there is a (minimum) function f such that $\tau(D) \leq f(\nu(D))$ for every digraph D . With Theorem 1.1 (ii), this implies $\text{inv}(D) \leq f(\nu(D))$.

Theorem 1.5. *There is a (minimum) function g such that $\text{inv}(D) \leq g(\nu(D))$ for all oriented graph D and $g \leq 2f$.*

A natural question is then to determine this function g or at least obtain good upper bounds on it. Note that the upper bound on f given by Reed et al. [12] proof is huge (a multiply iterated exponential, where the number of iterations is also a multiply iterated exponential). The only known value has been established by McCuaig [10] who proved $f(1) = 3$. As noted in [12], the best lower bound on f due to Alon (unpublished) is $f(k) \geq k \log k$. It might be that $f(k) = O(k \log k)$. This would imply the following conjecture.

Conjecture 1.6. For all k , $g(k) = O(k \log k)$: there is an absolute constant C such that $\text{inv}(D) \leq C \cdot \nu(D) \log(\nu(D))$ for all oriented graph D .

Note that for planar digraphs, combining results of Reed and Sheperd [13] and Goemans and Williamson [8], we get $\tau(D) \leq 63 \cdot \nu(D)$ for every planar digraph D . This implies that $\text{inv}(D) \leq 126 \cdot \nu(D)$ for every planar digraph D and so Conjecture 1.6 holds for planar oriented graphs.

Another natural question is whether or not the inequality $g \leq 2f$ is tight. In Section 4, we show that it is not the case. We show that $g(1) \leq 4$, while $f(1) = 3$ as shown by McCuaig [10]. However we do not know if this bound 4 on $g(1)$ is attained. Furthermore can we characterize the intercylic digraphs with small inversion number ?

Problem 1.7. For any $k \in [4]$, can we characterize the intercylic oriented graphs with inversion number k ?

In contrast to Theorem 1.1 and 1.5, the difference between inv and ν , τ , and τ' can be arbitrarily large as for every k , there are tournaments T_k for which $\text{inv}(T_k) = 1$ and $\nu(T_k) = k$. Consider for example the tournament T_k obtained from three transitive tournaments A, B, C of order k by adding all arc from A to B , B to C and C to A . One easily sees that $\nu(T_k) = k$ and so $\tau'(T_k) \geq \tau(T_k) \geq k$; moreover $\text{Inv}(T_k; A \cup B)$ is a transitive tournament, so $\text{inv}(T_k) = 1$.

1.2 Complexity of computing the inversion number

We also consider the complexity of computing the inversion number of an oriented graph and the following associated problem.

k-INVERSION.

Input: An oriented graph D .

Question: $\text{inv}(D) \leq k$?

We also study the complexity of the restriction of this problem to tournaments.

k-TOURNAMENT-INVERSION.

Input: A tournament.

Question: $\text{inv}(T) \leq k$?

Note that 0-INVERSION is equivalent to deciding whether an oriented graph D is acyclic. This can be done in $O(|V(D)|^2)$ time.

Let k be a positive integer. A tournament T is ***k*-inversion-critical** if $\text{inv}(T) = k$ and $\text{inv}(T - x) = k - 1$ for all $x \in V(T)$. We denote by \mathcal{IC}_k the set of *k*-inversion-critical tournaments. Observe that a tournament T has inversion number at least k if and only if T has a subtournament in \mathcal{IC}_k .

Theorem 1.8 (Belkhechine et al. [6]). *For any positive integer k , the set \mathcal{IC}_k is finite.*

Checking whether the given tournament T contains I for every element I in \mathcal{IC}_{k+1} , one can decide whether $\text{inv}(T) \geq k$ in $O(|V(T)|^{m_{k+1}})$ time, where m_{k+1} be maximum order of an element of \mathcal{IC}_{k+1} .

Corollary 1.9. *For any non-negative integer k , *k*-TOURNAMENT-INVERSION is polynomial-time solvable.*

The proof of Theorem 1.8 neither explicitly describes \mathcal{IC}_k nor gives upper bound on m_k . So the degree of the polynomial in Corollary 1.9 is unknown. This leaves open the following questions.

Problem 1.10. Explicitly describe \mathcal{IC}_k or at least find an upper bound on m_k .

What is the minimum real number r_k such that *k*-TOURNAMENT-INVERSION can be solved in $O(|V(T)|^{r_k})$ time ?

As observed in [6], $\mathcal{IC}_1 = \{\vec{C}_3\}$, so $m_1 = 3$. This implies that 0-TOURNAMENT-INVERSION can be done in $O(n^3)$. However, deciding whether a tournament is acyclic can be solved in $O(n^2)$ -time. Belkhechine et al. [6] also proved that $\mathcal{IC}_2 = \{A_6, B_6, D_5, T_5, V_5\}$ where $A_6 = TT_2(\vec{C}_3) = \text{Inv}(TT_6; (\{v_1, v_3\}, \{v_4, v_6\}))$, $B_6 = \text{Inv}(TT_6; (\{v_1, v_4, v_5\}, \{v_2, v_5, v_6\}))$, $D_5 = \text{Inv}(TT_5; (\{v_2, v_4\}, \{v_1, v_5\}))$, $R_5 = \text{Inv}(TT_5; (\{v_1, v_3, v_5\}, \{v_2, v_4\}))$, and $V_5 = \text{Inv}(TT_5; (\{v_1, v_5\}, \{v_3, v_5\}))$. See Figure 1.

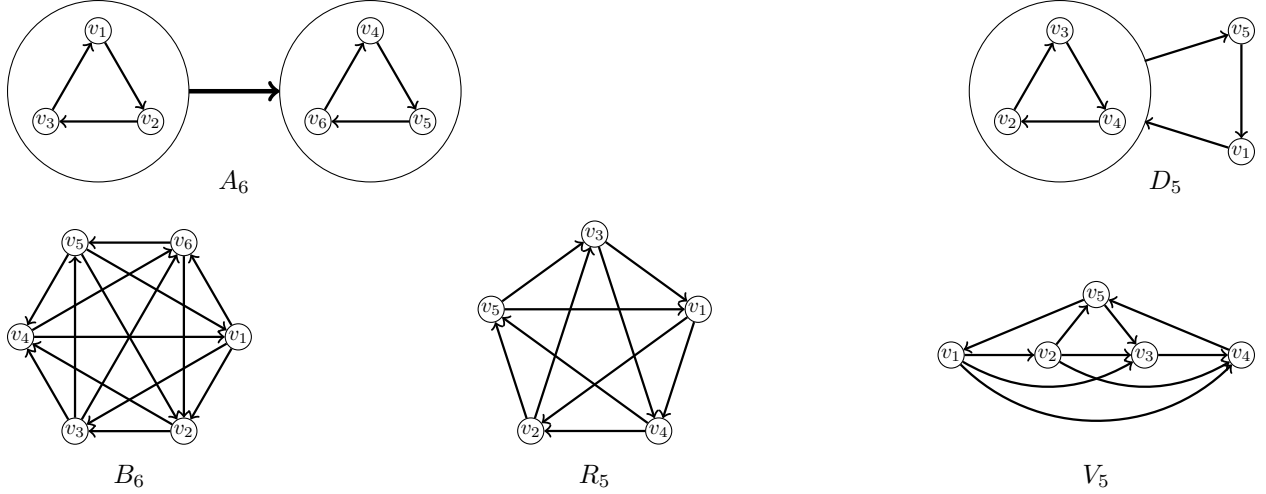

Figure 1: The 2-inversion-critical tournaments

Hence $m_2 = 6$, so 1-TOURNAMENT-INVERSION can be solved in $O(n^6)$ -time. This is not optimal: we show in Subsection 5.2 that it can be solved in $O(n^3)$ -time, and that 2-TOURNAMENT-INVERSION can be solved in $O(n^6)$ -time.

There is no upper bound on m_k so far. Hence since the inversion number of a tournament can be linear in its order (See e.g. tournament T_k described at the end of the introduction), Theorem 1.8 does not imply that one can compute the inversion number of a tournament in polynomial time. In fact, we believe that it is not.

Conjecture 1.11. Given a tournament and an integer k , deciding whether $\text{inv}(T) = k$ is NP-complete.

In contrast to Corollary 1.9, we show in Subsection 5.1 that 1-INVERSION is NP-complete. Note that together with Conjecture 1.3, this would imply that k -INVERSION is NP-complete for every positive integer k .

Conjecture 1.12. k -INVERSION is NP-complete for all positive integer k .

As we proved Conjecture 1.3. when $\text{inv}(L) = \text{inv}(R) = 1$, we get that 2-INVERSION is NP-complete.

Because of its relations with τ' , τ , and ν , (see Subsection 1.1), it is natural to ask about the complexity of computing the inversion number when restricted to oriented graphs (tournaments) for which one of these parameters is bounded. Recall that $\text{inv}(D) = 0$ if and only if D is acyclic, so if and only if $\tau'(D) = \tau(D) = \nu(D) = 0$.

Problem 1.13. Let k be a positive integer and γ be a parameter in $\{\tau', \tau, \nu\}$. What is the complexity of computing the inversion number of an oriented graph (tournament) D with $\gamma(D) \leq k$?

Conversely, it is also natural to ask about the complexity of computing any of τ' , τ , and ν , when restricted to oriented graphs with bounded inversion number. In Subsection 5.3, we show that computing any of these parameters is NP-hard even for oriented graphs with inversion number 1. However, the question remains open when we restrict to tournaments.

Problem 1.14. Let k be a positive integer and γ be a parameter in $\{\tau', \tau, \nu\}$. What is the complexity of computing $\gamma(T)$ for a tournament D with $\text{inv}(T) \leq k$?

2 Properties of the inversion number

In this section, we establish easy properties of the inversion number and deduce from them Theorem 1.1 and the fact that Conjecture 1.3 is equivalent to its restriction to tournaments.

The inversion number is monotone :

Proposition 2.1. If D' is a subdigraph of an oriented graph D , then $\text{inv}(D') \leq \text{inv}(D)$.

Proof. Let D' be a subdigraph of D . If $(X_i)_{i \in I}$ is a decycling family of D , then $(X_i \cap V(D'))_{i \in I}$ is a decycling family of D' . \square

Lemma 2.2. *Let D be a digraph. If D a source (a sink) x , then $\text{inv}(D) = \text{inv}(D - x)$.*

Proof. Every decycling family of $D - x$ is also a decycling family of D since adding a source (sink) to an acyclic digraph results in an acyclic digraph. \square

Lemma 2.3. *Let D be an oriented graph and let x be a vertex of D . Then $\text{inv}(D) \leq \text{inv}(D - x) + 2$.*

Proof. Let $N^+[x]$ be the closed out-neighbourhood of x , that is $\{x\} \cup N^+(x)$. Observe that $D' = \text{Inv}(D; (N^+[x], N^+(x)))$ is the oriented graph obtained from D by reversing the arc between x and its out-neighbours. Hence x is a sink in D' and $D' - x = D - x$. Thus, by Lemma 2.2, $\text{inv}(D) \leq \text{inv}(D') + 2 \leq \text{inv}(D - x) + 2$. \square

Proof of Theorem 1.1. As observed in the introduction, if F is a feedback arc-set, then the family of sets of end-vertices of arcs of F is a decycling family. So $\text{inv}(D) \leq \tau'(D)$.

Let $S = \{x_1, \dots, x_k\}$ be a cycle transversal with $k = \tau(D)$. Lemma 2.3 and a direct induction imply $\text{inv}(D) \leq \text{inv}(D - \{x_1, \dots, x_i\}) + 2i$ for all $i \in [k]$. Hence $\text{inv}(D) \leq \text{inv}(D - S) + 2k$. But, since S is a cycle transversal, $D - S$ is acyclic, so $\text{inv}(D - S) = 0$. Hence $\text{inv}(D) \leq 2k = 2\tau(D)$. \square

Let D be an oriented graph. An **extension** of D is a tournament T such that $V(D) = V(T)$ and $A(D) \subseteq A(T)$.

Lemma 2.4. *Let D be an oriented graph. There is an extension T of D such that $\text{inv}(T) = \text{inv}(D)$.*

Proof. Set $p = \text{inv}(D)$ and let $(X_i)_{i \in [p]}$ be a decycling family of D . Then $D^* = \text{Inv}(D; (X_i)_{i \in [p]})$ is acyclic and so admits an acyclic ordering (v_1, \dots, v_n) .

Let T be the extension of D constructed as follows: For every $1 \leq i < j \leq p$ such that $v_i v_j \notin A(D^*)$, let $n(i, j)$ be the number of $X_i, i \in [p]$, such that $\{v_i, v_j\} \subseteq X_i$. If $n(i, j)$ is even then the arc $v_i v_j$ is added to $A(T)$, and if $n(i, j)$ is odd then the arc $v_j v_i$ is added to $A(T)$. Note that in the first case, $v_i v_j$ is reversed an even number of times by $(X_i)_{i \in [p]}$, and in the second $v_j v_i$ is reversed an odd number of times by $(X_i)_{i \in [p]}$. Thus, in both cases, $v_i v_j \in \text{Inv}(T; (X_i)_{i \in [p]})$. Consequently, (v_1, \dots, v_n) is also an acyclic ordering of $\text{Inv}(T; (X_i)_{i \in [p]})$. Hence $\text{inv}(T) \leq \text{inv}(D)$, and so, by Proposition 2.1, $\text{inv}(T) = \text{inv}(D)$. \square

Proposition 2.5. *Conjecture 1.3 is equivalent to its restriction to tournaments.*

Proof. Suppose there are oriented graphs L, R that form a counterexample to Conjecture 1.3, that is such that $\text{inv}(L \rightarrow R) < \text{inv}(L) + \text{inv}(R)$. By Lemma 2.4, there is an extension T of $L \rightarrow R$ such that $\text{inv}(T) = \text{inv}(L \rightarrow R)$ and let $T_L = T \langle V(L) \rangle$ and $T_R = T \langle V(R) \rangle$. We have $T = T_L \rightarrow T_R$ and by Proposition 2.1, $\text{inv}(L) \leq \text{inv}(T_L)$ and $\text{inv}(R) \leq \text{inv}(T_R)$. Hence $\text{inv}(T) < \text{inv}(T_L) + \text{inv}(T_R)$, so T_L and T_R are two tournaments that form a counterexample to Conjecture 1.3. \square

3 Inversion number of dijoins of oriented graphs

Proposition 3.1. $\text{inv}(L \rightarrow R) \leq \text{inv}(L) + \text{inv}(R)$.

Proof. First invert $\text{inv}(L)$ subsets of $V(L)$ to make L acyclic, and then invert $\text{inv}(R)$ subsets of $V(R)$ to make R acyclic. This makes $L \rightarrow R$ acyclic. \square

Proposition 3.2. *If $\text{inv}(L), \text{inv}(R) \geq 1$, then $\text{inv}(L \rightarrow R) \geq 2$.*

Proof. Assume $\text{inv}(L), \text{inv}(R) \geq 1$. Then L and R are not acyclic, so let C_L and C_R be directed cycles in L and R respectively. Assume for a contradiction that there is a set X such that inverting X in $L \rightarrow R$ results in a acyclic digraph D' . There must be an arc xy in $A(C_L)$ such that $x \in X$ and $y \notin X$, and there must be $z \in X \cap V(C_R)$. But then (x, y, z, x) is a directed cycle in D' , a contradiction. \square

Further than Proposition 3.2, the following result give some property of a minimum decycling family of $L \rightarrow R$ when $\text{inv}(L) = \text{inv}(R) = 1$.

Theorem 3.3. *Let $D = (L \rightarrow R)$, where L and R are two oriented graphs with $\text{inv}(L) = \text{inv}(R) = 1$. Then, for any decycling family (X_1, X_2) of D , either $X_1 \subset V(L), X_2 \subset V(R)$ or $X_1 \subset V(L), X_2 \subset V(R)$.*

Proof. Let (X_1, X_2) be a decycling family of D and let D^* be the acyclic digraph obtained after inverting X_1 and X_2 (in symbols $D^* = \text{Inv}(D; (X_1, X_2))$).

Let us define some sets. See Figure 2.

- For $i \in [2]$, $X_i^L = X_i \cap V(L)$ and $X_i^R = X_i \cap V(R)$.
- $Z^L = V(L) \setminus (X_1^L \cup X_2^L)$ and $Z^R = V(R) \setminus (X_1^R \cup X_2^R)$.
- $X_{12}^L = X_1^L \cap X_2^L$ and $X_{12}^R = X_1^R \cap X_2^R$.
- for $\{i, j\} = \{1, 2\}$, $X_{i-j}^L = (X_i^L \setminus X_j^L)$ and $X_{i-j}^R = (X_i^R \setminus X_j^R)$.

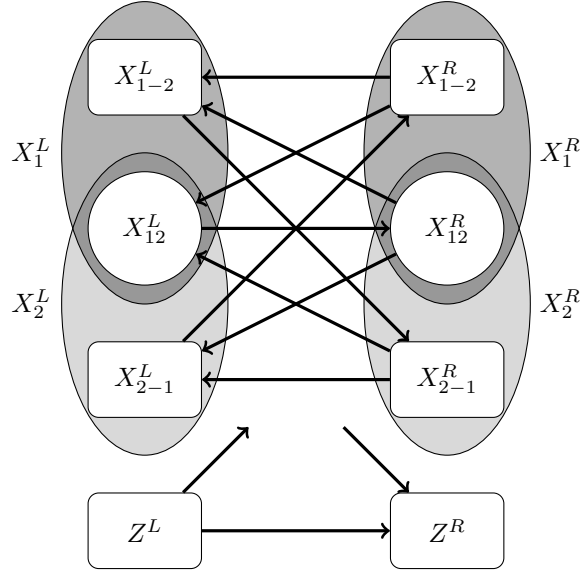

Figure 2: The oriented graph D^*

Observe that at least one of the sets $X_{1-2}^L, X_{2-1}^R, X_{2-1}^L$ and X_{1-2}^R must be empty, otherwise D^* is not acyclic. By symmetry, we may assume that it is X_{1-2}^R or X_{2-1}^L . Observe moreover that $X_{1-2}^R \cup X_{2-1}^L \neq \emptyset$ for otherwise $X_1^F = X_2^F = X_{12}^F$ and $D^*(V(F)) = F$ is not acyclic.

Assume first that $X_{1-2}^R = \emptyset$ and so $X_{2-1}^L \neq \emptyset$.

Suppose for a contradiction that $X_{12}^R \neq \emptyset$ and let $a \in X_{2-1}^R, b \in X_{12}^R$. Let C be a directed cycle in L . Note that $V(C)$ cannot be contained in one of the sets X_{1-2}^L, X_{12}^L or X_{2-1}^L . If $V(C) \cap Z^L \neq \emptyset$, there is an arc $cd \in A(L)$ such that $c \in X_{1-2}^L \cup X_{12}^L \cup X_{2-1}^L$ and $d \in Z^L$. Then, either (c, d, a, c) or (c, d, b, c) is a directed cycle in D^* , a contradiction. Thus, $V(C) \subseteq X_{1-2}^L \cup X_{12}^L \cup X_{2-1}^L$. If $V(C) \cap X_{12}^L \neq \emptyset$, then there is an arc $cd \in A(L)$ such that $c \in X_{12}^L$ and $d \in X_{1-2}^L \cup X_{2-1}^L$ which means that $dc \in A(D^*)$ and (d, c, b, d) is a directed cycle in D^* , a contradiction. Hence $V(C) \subseteq X_{1-2}^L \cup X_{2-1}^L$ and there exists an arc $cd \in A(L)$ such that $c \in X_{2-1}^L, d \in X_{1-2}^L$ and (c, d, a, c) is a directed cycle in D^* , a contradiction.

Therefore $X_{12}^R = \emptyset$ and every directed cycle of R has its vertices in $X_{2-1}^R \cup Z^R$. Then, there is an arc $ea \in A(R)$ with $a \in X_{2-1}^R$ and $e \in Z^R$. Note that, in this case, $ea \in A(D^*)$ and (e, a, c, e) is a directed cycle in D^* for any $c \in X_{12}^L \cup X_{2-1}^L$. Thus, $X_{12}^L = X_{2-1}^L = \emptyset$ and $X_1 \subset V(L), X_2 \subset V(R)$.

If $X_{2-1}^R = \emptyset$, we can symmetrically apply the same arguments to conclude that $X_1 \subset V(R)$ and $X_2 \subset V(L)$. \square

Theorem 3.4. Let L and R be two oriented graphs. If $\text{inv}(L) = 1$ and $\text{inv}(R) = 2$, then $\text{inv}(L \rightarrow R) = 3$.

Proof. Let $D = (L \rightarrow R)$. By Proposition 3.1, we know that $\text{inv}(D) \leq 3$.

Assume for a contradiction that $\text{inv}(D) \leq 2$. Let (X_1, X_2) be a decycling family of D and let $D^* = \text{Inv}(D; (X_1, X_2))$. Let $L^* = D^* \langle V(L) \rangle$ and $R^* = D^* \langle V(R) \rangle$. We define the sets $X_1^L, X_2^L, X_1^R, X_2^R, Z^L, Z^R, X_{12}^L, X_{12}^R, X_{1-2}^L, X_{2-1}^L, X_{1-2}^R$, and X_{2-1}^R as in Theorem 3.3. See Figure 2. Note that each of these sets induces an acyclic digraph in D^* and thus also in D . For $i \in [2]$, let $D_i = \text{Inv}(D; X_i)$, let $L_i = \text{Inv}(L, X_i^L) = \text{Inv}(L^*; X_{2-i}^L)$, and $R_i = \text{Inv}(R, X_i^R) = \text{Inv}(R^*; X_{2-i}^R)$. Since $\text{inv}(D) = 2$, $\text{inv}(D_1) = \text{inv}(D_2) = 1$. Since $\text{inv}(R) = 2$, R_1 and R_2 are both non-acyclic, so $\text{inv}(R_1) = \text{inv}(R_2) = 1$.

Claim 1: $X_i^L, X_i^R \neq \emptyset$ for all $i \in [2]$.

Proof. Since $\text{inv}(R) = 2$, necessarily, $X_1^R, X_2^R \neq \emptyset$.

Suppose now that $X_i^L = \emptyset$. Then $D_i = L \rightarrow R_i$. As $\text{inv}(L) \geq 1$ and $\text{inv}(R_i) \geq 1$, by Proposition 3.2 $\text{inv}(D_i) \geq 2$, a contradiction. \diamond

Claim 2: $X_1^L \neq X_2^L$ and $X_1^R \neq X_2^R$.

Proof. If $X_1^L = X_2^L$, then $L^* = L$, so L^* is not acyclic, a contradiction. Similarly, If $X_1^R = X_2^R$, then $R^* = R$, so R^* is not acyclic, a contradiction. \diamond

In particular, Claim 2 implies that $X_{1-2}^L \cup X_{2-1}^L \neq \emptyset$.

In the following, we denote by $A \rightsquigarrow B$ the fact that there is no arc from B to A .

Assume first that $X_{1-2}^R = \emptyset$. By Claim 1, $X_1^R \neq \emptyset$, so $X_{12}^R \neq \emptyset$ and by Claim 2, $X_1^R \neq X_2^R$, so $X_{2-1}^R \neq \emptyset$.

If $X_{2-1}^L \neq \emptyset$, then, in D^* , $X_{2-1}^R \cup X_{12}^R \rightsquigarrow Z^R$ because $X_{2-1}^R \cup X_{12}^R \rightarrow X_{2-1}^L \rightarrow Z^R$. But then $R_1 = \text{Inv}(R^*; X_2^R)$ would be acyclic, a contradiction. Thus, $X_{2-1}^L = \emptyset$.

Then by Claims 1 and 2, we get $X_{12}^L, X_{1-2}^L \neq \emptyset$. Hence, as $X_{12}^R \rightarrow X_{1-2}^L \rightarrow X_{2-1}^R \rightarrow X_{12}^L \rightarrow X_{12}^R$ in D^* , there is a directed cycle in D^* , a contradiction. Therefore $X_{1-2}^R \neq \emptyset$.

In the same way, one shows that $X_{2-1}^R \neq \emptyset$. As $X_{1-2}^R \rightarrow X_{1-2}^L \rightarrow X_{2-1}^R \rightarrow X_{2-1}^L \rightarrow X_{1-2}^R$ in D^* , and D^* is acyclic, one of X_{1-2}^L and X_{2-1}^L must be empty. Without loss of generality, we may assume $X_{1-2}^L = \emptyset$.

Then by Claims 1 and 2, we have $X_{12}^L, X_{1-2}^L \neq \emptyset$. Furthermore $X_{12}^R = \emptyset$ because $X_{12}^R \rightarrow X_{2-1}^L \rightarrow X_{1-2}^R \rightarrow X_{12}^L \rightarrow X_{12}^R$ in D^* . Now in D^* , $X_{2-1}^R \rightsquigarrow X_{1-2}^R \cup Z^R$ because $X_{2-1}^R \rightarrow X_{2-1}^L \rightarrow X_{1-2}^R \cup Z^R$, and $X_{1-2}^R \rightsquigarrow Z^R$ because $X_{1-2}^R \rightarrow X_{12}^L \rightarrow Z^R$. Thus, in D , we also have $X_{2-1}^R \rightsquigarrow X_{1-2}^R \cup Z^R$ and $X_{1-2}^R \rightsquigarrow Z^R$. So R is acyclic, a contradiction to $\text{Inv}(R) = 2$.

Therefore $\text{inv}(D) \geq 3$. So $\text{inv}(D) = 3$. \square

Corollary 3.5. $\text{inv}(D) = 1$ if and only if $\text{inv}(D \rightarrow D) = 2$.

Theorem 3.6. Let L and R be strong digraphs such that $\text{inv}(L), \text{inv}(R) \geq 2$. Then $\text{inv}(L \rightarrow R) \geq 4$.

Due to lack of space, the proof of this theorem is left in appendix.

Corollary 3.7. Let L and R be strong digraphs such that $\text{inv}(L), \text{inv}(R) = 2$. Then $\text{inv}(L \rightarrow R) = 4$.

4 Inversion number of intercylic digraphs

A digraph D is **intercylic** if $\nu(D) = 1$. The aim of this subsection is to prove the following theorem.

Theorem 4.1. If D is an intercylic oriented graph, then $\text{inv}(D) \leq 4$.

In order to prove this theorem, we need some preliminaries.

Let D be an oriented graph. An arc uv is **weak** in D if $\min\{d^+(u), d^-(v)\} = 1$. An arc is **contractable** in D if it is weak and in no directed 3-cycle. If a is a contractable arc, then let D/a be the digraph obtained by contracting the arc a and \tilde{D}/a be the oriented graph obtained from D by removing one arc from every pair of parallel arcs created in D/a .

Lemma 4.2. *Let D be a strong oriented graph and let a be a contractable arc in D . Then D/a is a strong intercyclic oriented graph and $\text{inv}(\tilde{D}/a) \geq \text{inv}(D)$.*

Proof. McCuaig proved that D/a is strong and intercyclic. Let us prove that $\text{inv}(D) \leq \text{inv}(\tilde{D}/a)$. Observe that $\text{inv}(\tilde{D}/a) = \text{inv}(D/a)$.

Set $a = uv$, and let w be the vertex corresponding to both u and v in D/a . Let (X'_1, \dots, X'_p) be a decycling family of $D' = \tilde{D}/a$ that result in an acyclic oriented graph R' . For $i \in [p]$, let $X_i = X'_i$ if $w \notin X'_i$ and $X_i = (X'_i \setminus \{w\}) \cup \{u, v\}$ if $w \in X'_i$. Let $a^* = uv$ if w is in an even number of X'_i and $a^* = vu$ otherwise, and let $R = \text{Inv}(D; (X_1, \dots, X_p))$. One easily shows that $R = R'/a^*$. Therefore R is acyclic since the contraction of an arc transforms a directed cycle into a directed cycle. \square

Lemma 4.3. *Let D be an intercyclic oriented graph. If there is a non-contractable weak arc, then $\text{inv}(D) \leq 4$.*

Proof. Let uv be a non-contractable weak arc. By directional duality, we may assume that $d^-(v) = 1$. Since uv is non-contractable, uv is in a directed 3-cycle (u, v, w, u) . Since D is intercyclic, we have $D \setminus \{u, v, w\}$ is acyclic. Consequently, $\{w, u\}$ is a cycle transversal of D , because every directed cycle containing v also contains u . Hence, by Theorem 1.1, $\text{inv}(D) \leq \tau(D) \leq 4$. \square

The description below follows [3]. A digraph D is **in reduced form** if it is strongly connected, and it has no weak arc, that is $\min\{\delta^-(D), \delta^+(D)\} \geq 2$.

Intercyclic digraphs in reduced form were characterized by Mc Cuaig [10]. In order to restate his result, we need some definitions. Let $\mathcal{P}(x_1, \dots, x_s; y_1, \dots, y_t)$ be the class of acyclic digraphs D such that x_1, \dots, x_s , $s \geq 2$, are the sources of D , y_1, \dots, y_t , $t \geq 2$, are the sinks of D , every vertex which is neither a source nor a sink has in- and out-degree at least 2, and, for $1 \leq i < j \leq s$ and $1 \leq k < \ell \leq t$, every (x_i, y_ℓ) -path intersects every (x_j, y_k) -path. By a theorem of Metzlar [11], such a digraph can be embedded in a disk such that $x_1, x_2, \dots, x_s, y_t, y_{t-1}, \dots, y_1$ occur, in this cyclic order, on its boundary. Let \mathcal{T} be the class of digraphs with minimum in- and out-degree at least 2 which can be obtained from a digraph in $\mathcal{P}(x^+, y^+; x^-, y^-)$ by identifying $x^+ = x^-$ and $y^+ = y^-$. Let D_7 be the digraph from Figure 3(a).

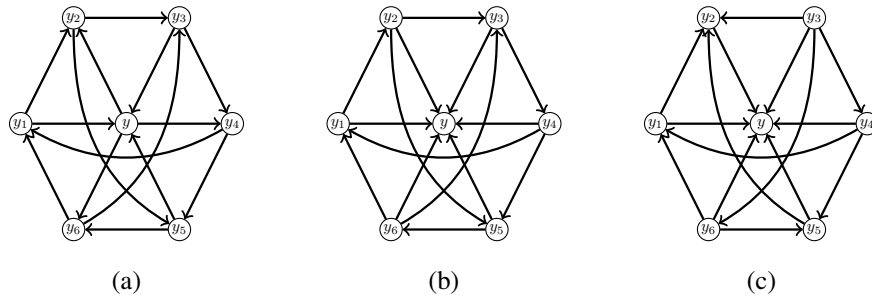

Figure 3: (a): the digraph D_7 ; (b): the digraph D_7' obtained from D_7 inverting the set $\{y, y_2, y_4, y_6\}$; (c): the acyclic digraph D_7'' obtained from D_7' by inverting the set $\{y_2, y_3, y_5, y_6\}$.

Let \mathcal{K} be the class of digraphs D with $\tau(D) \geq 3$ and $\delta^0(D) \geq 2$ which can be obtained from a digraph K_H from $\mathcal{P}(w_0, z_0; z_1, w_1)$ by adding at most one arc connecting w_0, z_0 , adding at most one arc connecting w_1, z_1 , adding a directed 4-cycle $(x_0, x_1, x_2, x_3, x_0)$ disjoint from K_H and adding eight single arcs $w_1x_0, w_1x_2, z_1x_1, z_1x_3, x_0w_0, x_2w_0, x_1z_0, x_3z_0$ (see Figure 4). Let \mathcal{H} be the class of digraphs D with $\tau(D) \geq 3$ and $\delta^0(D) \geq 2$ such that D is the union of three arc-disjoint digraphs $H_\alpha \in \mathcal{P}(y_4, y_3, y_1; y_5, y_2)$, $H_\beta \in \mathcal{P}(y_4, y_5; y_3, y_1, y_2)$, and $H_\gamma \in \mathcal{P}(y_1, y_2; y_3, y_4)$, where y_1, y_2, y_3, y_4, y_5 are the only vertices in D occurring in more than one of $H_\alpha, H_\beta, H_\gamma$ (see Figure 5).

Theorem 4.4 (McCuaig [10]). *The class of intercyclic digraphs in reduced form is $\mathcal{T} \cup \{D_7\} \cup \mathcal{K} \cup \mathcal{H}$.*

Using this characterization we can now prove the following.

Corollary 4.5. *If D is an intercyclic oriented graph in reduced form, then $\text{inv}(D) \leq 4$.*

Proof. Let D be an intercyclic oriented graph in reduced form. By Theorem 4.4, it is in $\mathcal{T} \cup \{D_7\} \cup \mathcal{K} \cup \mathcal{H}$.

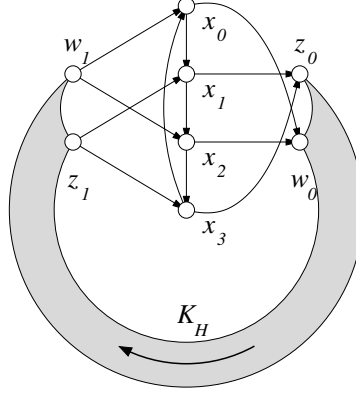

Figure 4: The digraphs from \mathcal{K} . The arrow in the grey area symbolizing the acyclic (plane) digraph K_H indicates that z_0, w_0 are its sources and z_1, w_1 are its sinks.

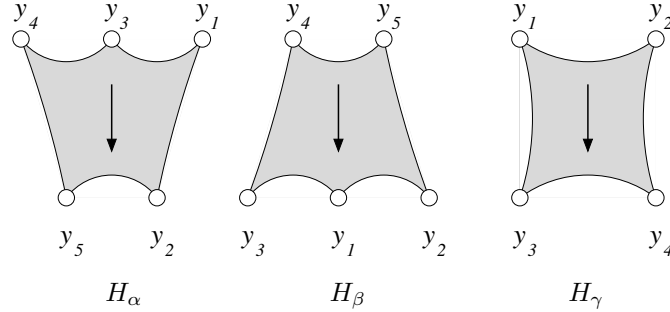

Figure 5: The digraphs from \mathcal{H} .

If $D \in \mathcal{T}$, then it is obtained from a digraph D' in $\mathcal{P}(x^+, y^+; x^-, y^-)$ by identifying $x^+ = x^-$ and $y^+ = y^-$. Thus $D - \{x^+, y^+\} = D' - \{x^+, y^+, x^-, y^-\}$ is acyclic. Hence $\tau(D) \leq 2$, and so by Theorem 1.1, $\text{inv}(D) \leq 4$.

If $D = D_7$, then inverting $X_1 = \{y, y_2, y_4, y_6\}$ so that y becomes a source and then inverting $\{y_2, y_3, y_5, y_6\}$, we obtain an acyclic digraph with acyclic ordering $(y, y_6, y_3, y_4, y_5, y, y_2)$. Hence $\text{inv}(D_7) \leq 2$.

If $D \in \mathcal{K}$, then inverting $\{x_0, x_3\}$ and $\{x_0, x_1, x_2, x_3, w_1, z_1\}$, we convert D to an acyclic digraph with acyclic ordering $(x_3, x_2, x_1, x_0, v_1, \dots, v_p)$ where (v_1, \dots, v_p) is an acyclic ordering of K_H .

If $D \in \mathcal{H}$, then consider $D' = \text{Inv}(D, V(H_\gamma))$. The oriented graph D is the union of $H_\alpha \in \mathcal{P}(y_4, y_3, y_1; y_5, y_2)$, $H_\beta \in \mathcal{P}(y_4, y_5; y_3, y_1, y_2)$, and $\overleftarrow{H_\gamma}$, the converse of H_γ . As $H_\gamma \in \mathcal{P}(y_1, y_2; y_3, y_4)$, we have $\overleftarrow{H_\gamma} \in \mathcal{P}(y_4, y_3; y_2, y_1)$. Set $Y = \{y_1, y_2, y_3, y_4, y_5\}$.

We claim that every directed cycle C' of D' contains y_5 . Since $D' - Y$ is acyclic, C' is the concatenation of directed paths P_1, P_2, \dots, P_q with both end-vertices in Y and no internal vertex in Y . Now let C be the directed cycle obtained from C' by replacing each P_i by an arc from its initial vertex to its terminal vertex. Clearly, C contains y_5 if and only if C' does. But C is a directed cycle in J the digraph with vertex set Y in which $\{y_4, y_3, y_1\} \rightarrow \{y_5, y_2\}$, $\{y_4, y_5\} \rightarrow \{y_3, y_1, y_2\}$, and $\{y_4, y_3\} \rightarrow \{y_1, y_2\}$. One easily checks that $J - y_5$ is acyclic with acyclic ordering (y_4, y_3, y_1, y_2) , so C contains y_5 and so does C' .

Consequently, $\{y_5\}$ is a cycle transversal of D' . Hence, by Theorem 1.1 (ii), we have $\text{inv}(D') \leq 2\tau(D') \leq 2$. As D' is obtained from D by inverting one set, we get $\text{inv}(D) \leq 3$. \square

We can now prove Theorem 4.1.

Proof. By induction on the number of vertices of D .

If D is not strong, then it has a unique non-trivial strong component C and any decycling family of C is a decycling family of D , so $\text{inv}(C) = \text{inv}(D)$. By the induction hypothesis, $\text{inv}(C) \leq 4$, so $\text{inv}(D) \leq 4$. Henceforth, we may assume that D is strong.

Assume now that D has a weak arc a . If a is non-contractable, then $\text{inv}(D) \leq 9$ by Lemma 4.3. If a is contractable, then consider \tilde{D}/a . As observed by McCuaig [10], D/a is also intercylic. So by Lemma 4.2 and the induction hypothesis, $\text{inv}(D) \leq \text{inv}(D/a) \leq 4$. Henceforth, we may assume that D has no weak arc.

Thus D is in a reduced form and by Corollary 4.5, $\text{inv}(D) \leq 4$. \square

5 Complexity results

5.1 NP-hardness of 1-INVERSION and 2-INVERSION

Theorem 5.1. *1-INVERSION is NP-complete even when restricted to strong digraphs.*

In order to prove this theorem, we need some preliminaries.

Let J be the digraph depicted in Figure 6.

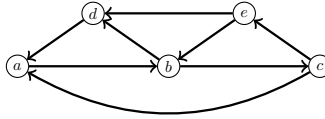

Figure 6: The digraph J

Lemma 5.2. *The only sets whose inversion can make J acyclic are $\{a, b, e\}$ and $\{b, c, d\}$.*

Proof. Assume that an inversion on X makes D acyclic. Then X must contain exactly two vertices of each of the directed 3-cycles (a, b, c, a) , (a, b, d, a) , and (e, b, c, e) , and cannot be $\{a, c, d, e\}$ for otherwise (e, b, d, e) is a directed cycle in the resulting digraph. Hence X must be either $\{a, b, e\}$ or $\{b, c, d\}$. One can easily check that an inversion on any of these two sets makes D acyclic. \square

Proof of Theorem 5.1. Reduction from MONOTONE 1-IN-3 SAT which is well-known to be NP-complete.

Let Φ be a monotone 3-SAT formula with variables x_1, \dots, x_n and clauses C_1, \dots, C_m . Let D be the digraph constructed as follows. For every $i \in [n]$, let us construct a variable digraph K_i as follows: for every $j \in [m]$, create a copy J_i^j of J , and then identify all the vertices c_i^j into one vertex c_i . Then, for every clause $C_j = x_{i_1} \vee x_{i_2} \vee x_{i_3}$, we add the arcs of the directed 3-cycle $D_j = (a_{i_1}^j, a_{i_2}^j, a_{i_3}^j)$.

Observe that D is strong. We shall prove that $\text{inv}(D) = 1$ if and only if Φ admits a 1-in-3-SAT assignment.

Assume first that $\text{inv}(D) = 1$. Let X be a set whose inversion makes D acyclic. By Lemma 5.2, for every $i \in [n]$, either $X \cap V(K_i) = \bigcup_{j=1}^m \{a_i^j, b_i^j, e_i^j\}$ or $X \cap V(K_i) = \bigcup_{j=1}^m \{b_i^j, c_i, d_i^j\}$. Let φ be the truth assignment defined by $\varphi(x_i) = \text{true}$ if $X \cap V(K_i) = \bigcup_{j=1}^m \{b_i^j, c_i, d_i^j\}$, and $\varphi(x_i) = \text{false}$ if $X \cap V(K_i) = \bigcup_{j=1}^m \{a_i^j, b_i^j, e_i^j\}$.

Consider a clause $C_j = x_{i_1} \vee x_{i_2} \vee x_{i_3}$. Because D_j is a directed 3-cycle, X contains exactly two vertices in $V(D_j)$. Let ℓ_1 and ℓ_2 be the two indices of $\{i_1, i_2, i_3\}$ such that $a_{\ell_1}^j$ and $a_{\ell_2}^j$ are in X and ℓ_3 be the third one. By our definition of φ , we have $\varphi(x_{\ell_1}) = \varphi(x_{\ell_2}) = \text{false}$ and $\varphi(x_{\ell_3}) = \text{true}$. Therefore, φ is a 1-in-3 SAT assignment.

Assume now that Φ admits a 1-in-3 SAT assignment φ . For every $i \in [n]$, let $X_i = \bigcup_{j=1}^m \{b_i^j, c_i, d_i^j\}$ if $\varphi(x_i) = \text{true}$ and $X_i = \bigcup_{j=1}^m \{a_i^j, b_i^j, e_i^j\}$ if $\varphi(x_i) = \text{false}$, and set $X = \bigcup_{i=1}^n X_i$.

Let D' be the graph obtained from D by the inversion on X . We shall prove that D is acyclic, which implies $\text{inv}(D) = 1$.

Assume for a contradiction that D' contains a cycle C . By Lemma 5.2, there is no cycle in any variable gadget K_i , so C must contain an arc with both ends in $V(D_j)$ for some j . Let $C_j = x_{i_1} \vee x_{i_2} \vee x_{i_3}$. Now since φ is a 1-in-3-SAT

assignment, w.l.o.g., we may assume that $\varphi(x_{i_1}) = \varphi(x_{i_2}) = \text{false}$ and $\varphi(x_{i_3}) = \text{true}$. Hence in D' , $a_{i_2}^j \rightarrow a_{i_1}^j$, $a_{i_2}^j \rightarrow a_{i_3}^j$, and $a_{i_3}^j \rightarrow a_{i_1}^j$. Moreover, in $D' \langle V(J_{i_1}^j) \rangle$, $a_{i_1}^j$ is a sink, so $a_{i_1}^j$ is a sink in D' . Therefore C does not go through $a_{i_1}^j$, and thus C contains the arc $a_{i_2}^j a_{i_3}^j$, and then enter $J_{i_3}^j$. But in $D' \langle V(J_{i_3}^j) \rangle$, $a_{i_3}^j$ has a unique out-neighbour, namely $b_{i_3}^j$, which is a sink. This is a contradiction. \square

Corollary 5.3. 2-INVERSION is NP-complete.

Proof. By Corollary 3.5, we have $\text{inv}(D \rightarrow D) = 2$ if and only $\text{inv}(D) = 1$, so the statement follows from Theorem 5.1. \square

5.2 Solving k -TOURNAMENT-INVERSION for $k \in \{1, 2\}$

Theorem 5.4. 1-TOURNAMENT-INVERSION can be solved in $O(n^3)$ time.

Proof. Let T be a tournament. For every vertex v one can check whether there is an inversion that transforms T into a transitive tournament with source v . Indeed the unique possibility inversion is the one on the closed in-neighbourhood of v , $N^-[v] = N^-(v) \cup \{v\}$. So one can make inversion on $N^-[v]$ and check whether the resulting tournament is transitive. This can obviously be done in $O(n^2)$ time

Doing this for every vertex v yields an algorithm which solves 1-TOURNAMENT-INVERSION in $O(n^3)$ time. \square

Theorem 5.5. 2-TOURNAMENT-INVERSION can be solved in $O(n^6)$ time.

The main idea to prove this theorem is to consider every pair (s, t) of vertices and to check whether there are two sets X_1, X_2 such that the inversion of X_1 and X_2 results in a transitive tournament with source s and sink t . We need some definitions and lemmas.

The **symmetric difference** of two sets A and B is $A \Delta B = (A \setminus B) \cup (B \setminus A)$.

Let T be a tournament and let s and t be two vertices of T . We define the following four sets

$$\begin{aligned} A(s, t) &= N^+(s) \cap N^-(t) \\ B(s, t) &= N^-(s) \cap N^+(t) \\ C(s, t) &= N^+(s) \cap N^+(t) \\ D(s, t) &= N^-(s) \cap N^-(t) \end{aligned}$$

Lemma 5.6. Let T be a tournament and let s and t be two vertices of T . Assume there are two sets X_1, X_2 such that the inversion of X_1 and X_2 results in a transitive tournament with source s and sink t .

- (1) If $\{s, t\} \subseteq X_1 \setminus X_2$, then $ts \in A(T)$, $C(s, t) = D(s, t) = \emptyset$ and $X_1 = \{s, t\} \cup B(s, t)$.
- (2) If $s \in X_1 \setminus X_2$, $t \in X_2 \setminus X_1$, and the inversion of X_1 and X_2 makes T acyclic, then $st \in A(T)$, $A(s, t) \cap (X_1 \cup X_2) = \emptyset$, $X_1 = \{s\} \cup B(s, t) \cup D(s, t)$, and $X_2 = \{t\} \cup B(s, t) \cup C(s, t)$.
- (3) If $s \in X_1 \cap X_2$ and $t \in X_1 \setminus X_2$, then $ts \in A(T)$, $X_1 = \{s, t\} \cup B(s, t) \cup C(s, t)$, and $X_2 = \{s\} \cup C(s, t) \cup D(s, t)$.
- (4) If $\{s, t\} \subseteq X_1 \cap X_2$, then $st \in A(T)$, $C(s, t) = \emptyset$, $D(s, t) = \emptyset$, $X_1 \cap X_2 \subseteq A(s, t) \cup \{s, t\}$, and $B(s, t) = X_1 \Delta X_2$.

Proof. (1) The arc between s and t is reversed once, so $ts \in A(T)$.

Assume for a contradiction, that there is a vertex $c \in C(s, t)$. The arc tc must be reversed, so $c \in X_1$, but then the arc sc is reversed contradicting the fact that s becomes a source. Hence $C(s, t) = \emptyset$. Similarly $D(s, t) = \emptyset$.

The arcs from t to $B(s, t)$ and from $B(s, t)$ to s are reversed so $B(s, t) \subseteq X_1$. The arcs from s to $A(s, t)$ and from $A(s, t)$ to t are not reversed so $A(s, t) \cap X_1 = \emptyset$. Therefore $X_1 = \{s, t\} \cup B(s, t)$.

(2) The arc between s and t is not reversed, so $st \in A(T)$. The arcs from s to $A(s, t)$ and from $A(s, t)$ to t are not reversed so $A(s, t) \cap X_1 = \emptyset$ and $A(s, t) \cap X_2 = \emptyset$. The arcs from t to $B(s, t)$ and from $B(s, t)$ to s are reversed so $B(s, t) \subseteq X_1$ and $B(s, t) \subseteq X_2$. The arcs from s to $C(s, t)$ are not reversed so $C(s, t) \cap X_1 = \emptyset$ and the arcs

from t to $C(s, t)$ are reversed so $C(s, t) \subseteq X_2$. The arcs from $D(s, t)$ to s are reversed so $D(s, t) \subseteq X_1$ and the arcs from $D(s, t)$ to d are not reversed so $D(s, t) \cap X_2 = \emptyset$. Consequently, $X_1 = \{s\} \cup B(s, t) \cup D(s, t)$, and $X_2 = \{t\} \cup B(s, t) \cup C(s, t)$.

(3) The arc between s and t is reversed, so $ts \in A(T)$. The arcs from $A(s, t)$ to t are not reversed so $A(s, t) \cap X_1 = \emptyset$. The arcs from s to $A(s, t)$ are not reversed so $A(s, t) \cap X_2 = \emptyset$. The arcs from t to $B(s, t)$ are reversed so $B(s, t) \subseteq X_1$. The arcs from $B(s, t)$ to s are reversed (only once) so $B(s, t) \cap X_2 = \emptyset$. The arcs from t to $C(s, t)$ are reversed so $C(s, t) \subseteq X_1$. The arcs from s to $C(s, t)$ must be reversed twice so $C(s, t) \subseteq X_2$. The arcs from $D(s, t)$ to t are not reversed so $D(s, t) \cap X_1 = \emptyset$. The arcs from $D(s, t)$ to s are reversed so $D(s, t) \subseteq X_2$. Consequently, $X_1 = \{s, t\} \cup B(s, t) \cup C(s, t)$, and $X_2 = \{s, t\} \cup C(s, t) \cup D(s, t)$.

(4) The arc between s and t is reversed twice, so $st \in A(T)$.

Assume for a contradiction, that there is a vertex $c \in C(s, t)$. The arc tc must be reversed, so c is in exactly one of X_1 and X_2 . But then the arc sc is reversed contradicting the fact that s becomes a source. Hence $C(s, t) = \emptyset$. Similarly $D(s, t) = \emptyset$. The arcs from s to $A(s, t)$ and from $A(s, t)$ to t are not reversed so every vertex of $A(s, t)$ is either in $X_1 \cap X_2$ or in $V(T) \setminus (X_1 \cup X_2)$. The arcs from t to $B(s, t)$ and from $B(s, t)$ to s are reversed so every vertex of $B(s, t)$ is either in $X_1 \setminus X_2$ or in $X_2 \setminus X_1$. Consequently, $X_1 \cap X_2 \subseteq A(s, t) \cup \{s, t\}$, and $B(s, t) = X_1 \Delta X_2$. \square

Lemma 5.7. *Let T be a tournament of order n and let s and t be two vertices of T .*

- (1) *One can decide in $O(n^3)$ time whether there are two sets X_1, X_2 such that the inversion of X_1 and X_2 results in a transitive tournament with source s and sink t and $\{s, t\} \subseteq X_1 \setminus X_2$.*
- (2) *One can decide in $O(n^2)$ time whether there are two sets X_1, X_2 such that the inversion of X_1 and X_2 results in a transitive tournament with source s and sink t and $s \in X_1 \setminus X_2$ and $t \in X_2 \setminus X_1$.*
- (3) *One can decide in $O(n^2)$ time whether there are two sets X_1, X_2 such that the inversion of X_1 and X_2 results in a transitive tournament with source s and sink t and $s \in X_1 \cap X_2$ and $t \in X_1 \setminus X_2$.*
- (4) *One can decide in $O(n^4)$ time whether there are two sets X_1, X_2 such that the inversion of X_1 and X_2 results in a transitive tournament with source s and sink t and $\{s, t\} \subseteq X_1 \cap X_2$.*

Proof. For all cases, we first compute $A(s, t)$, $B(s, t)$, $C(s, t)$, and $D(s, t)$, which can obviously be done in $O(n^2)$.

(1) By Lemma 5.6, we must have $ts \in A(T)$ and $C(s, t) = D(s, t) = \emptyset$. So we first check if this holds. Furthermore, by Lemma 5.6, we must have $X_1 = \{s, t\} \cup B(s, t)$. Therefore we invert $\{s, t\} \cup B(s, t)$ which results in a tournament T' . Observe that s is a source of T' and t is a sink of T' . Hence, we return ‘Yes’ if and only if $\text{inv}(T' - \{s, t\}) = 1$ which can be tested in $O(n^3)$ by Theorem 5.4.

(2) By Lemma 5.6, we must have $st \in A(T)$. So we first check if this holds. Furthermore, by Lemma 5.6, the only possibility is that $X_1 = \{s\} \cup B(s, t) \cup D(s, t)$, and $X_2 = \{t\} \cup B(s, t) \cup C(s, t)$. So we invert those two sets and check whether the resulting tournament is a transitive tournament with source s and sink t . This can be done in $O(n^2)$.

(3) By Lemma 5.6, we must have $ts \in A(T)$. So we first check if this holds. Furthermore, by Lemma 5.6, the only possibility is that $X_1 = \{s, t\} \cup B(s, t) \cup C(s, t)$, and $X_2 = \{s\} \cup C(s, t) \cup D(s, t)$. So we invert those two sets and check whether the resulting tournament is a transitive tournament with source s and sink t . This can be done in $O(n^2)$.

(4) By Lemma 5.6, we must have $st \in A(T)$, $C(s, t) = \emptyset$, $D(s, t) = \emptyset$. So we first check if this holds. Furthermore, by Lemma 5.6, the desired sets X_1 and X_2 must satisfy $X_1 \cap X_2 \subseteq A(s, t) \cup \{s, t\}$, and $B(s, t) = X_1 \Delta X_2$.

In particular, every arc of $T_A = T \langle A(s, t) \rangle$ is either not reversed or reversed twice (which is the same). Hence T_A must be a transitive tournament. So we check whether T_A is a transitive tournament and if yes, we find a directed hamiltonian path $P_A = (a_1, \dots, a_p)$ of it. This can be done in $O(n^2)$.

Now we check that $B(s, t)$ admits a partition (X'_1, X'_2) with $X'_i = X_i \cap B$ and the inversion of both X'_1 and X'_2 transforms $T \langle B(s, t) \rangle$ into a transitive tournament T_B with source s' and sink t' . The idea is to investigate all possibilities for s', t' and the sets X'_1 and X'_2 . Since (X'_1, X'_2) is a partition of $B(s, t)$ and (X'_1, X'_2) is a decycling family if and only if (X'_2, X'_1) is a decycling family, we may assume that

- (a) $\{s', t'\} \subseteq X'_1 \setminus X'_2$, or

(b) $s' \in X'_1 \setminus X'_2$ and $t' \in X'_2 \setminus X'_1$.

For the possibilities corresponding to Case (a), we proceed as in (1) above. For every arc $t's' \in A(T\langle B(s,t) \rangle)$, we check that $C(s',t') = D(s',t') = \emptyset$ (where those sets are computed in $T\langle B(s,t) \rangle$). Furthermore, by Lemma 5.6, we must have $X'_1 = \{s, t\} \cup B(s',t')$ and $X'_2 = B(s,t) \setminus X'_1$. So we invert those two sets and check whether the resulting tournament T_B is transitive. This can be done in $O(n^2)$ (or each arc $t's'$).

For a possibilities corresponding to Case (b), we proceed as in (2) above. For every arc $t's' \in A(T\langle B(s,t) \rangle)$, by Lemma 5.6, the only possibility is that $X'_1 = \{s'\} \cup B(s',t') \cup D(s',t')$, and $X'_2 = \{t'\} \cup B(s',t') \cup C(s',t')$. As those two sets form a partition of $B(s,t)$, we also must have $B(s',t') = \emptyset$ and $A(s',t') = \emptyset$. So we invert those two sets and check whether the resulting tournament T_B is transitive. This can be done in $O(n^2)$ for each arc $t's'$.

In both cases, we are left with a transitive tournament T_B . We compute its directed hamiltonian path $P_B = (b_1, \dots, b_q)$ which can be done in $O(n^2)$. We need to check whether this partial solution on $B(s,t)$ is compatible with the rest of the tournament, that is $\{s, t\} \cup A(s,t)$. It is obvious that it will always be compatible with s and t as they become source and sink. So we have to check that we can merge T_A and T_B into a transitive tournament on $A(s,t)$ and $B(s,t)$ after the reversals of X_1 and X_2 . In other words, we must interlace the vertices of P_A and P_B . Recall that $Z = X_1 \cap X_2 \setminus \{s, t\} \subseteq A(s,t)$ and $X_i = X'_i \cup Z \cup \{s, t\}$, $i \in [2]$ so the arcs between Z and $B(s,t)$ will be reversed exactly once when we invert X_1 and X_2 . Using this fact, one easily checks that this is possible if and only there are integers $j_1 \leq \dots \leq j_p$ such that

- either $b_j \rightarrow a_i$ for $j \leq j_i$ and $b_j \leftarrow a_i$ for $j > j_i$ (in which case $a_i \notin Z$ and the arcs between a_i and $B(s,t)$ are not reversed),
- or $b_j \leftarrow a_i$ for $j \leq j_i$ and $b_j \rightarrow a_i$ for $j > j_i$ (in which case $a_i \in Z$ and the arcs between a_i and $B(s,t)$ are reversed).

See Figure 7 for an illustration of a case when we can merge the two orderings after reversing X_1 and X_2 .

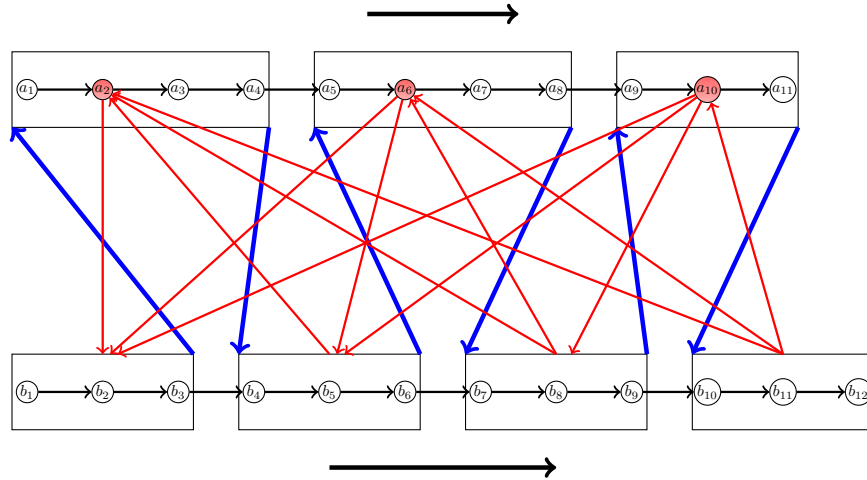

Figure 7: Indicating how to merge the two orderings of A and B . The fat blue edges indicate that the final ordering will be $b_1 - b_3, a_1 - a_4, b_4 - b_6, a_5 - a_8, b_7 - b_9, a_9 - a_{11}, b_{10} - b_{12}$. The set $Z = \{a_2, a_6, a_{10}\}$ consists of those vertices from $A(s,t)$ which are in $X_1 \cap X_2$. These vertices are shown in red. The red arcs between a vertex of Z and one of the boxes indicate that all arcs between the vertex and those of the box have the direction shown. Hence the boxes indicate that values of j_1, \dots, j_{11} satisfy that : $j_1 = \dots = j_4 = 3, j_5 = \dots = j_8 = 6, j_9 = \dots = j_{11} = 9$.

Deciding whether there are such indices can be done in $O(n^2)$ for each possibility.

As we have $O(n^2)$ possibilities, and for each possibility the procedure runs in $O(n^2)$ time. Hence the overall procedure runs in $O(n^4)$ time. \square

Proof of Theorem 5.5. By Lemma 2.2, by removing iterately the sources and sinks of the tournament, it suffices to solve the problem for a tournament with no sink and no source.

Now for each pair (s, t) of distinct vertices, one shall check whether there are two sets X_1, X_2 such that the inversion of X_1 and X_2 results in a transitive tournament with source s and sink t . Observe that since s and t are neither sources nor sinks in T , each of them must belong to at least one of X_1, X_2 . Therefore, without loss of generality, we are in one of the following possibilities:

- $\{s, t\} \subseteq X_1 \setminus X_2$. Such a possibility can be check in $O(n^3)$ by Lemma 5.7 (1).
- $s \in X_1 \setminus X_2$ and $t \in X_2 \setminus X_1$. Such a possibility can be check in $O(n^2)$ by Lemma 5.7 (2).
- $s \in X_1 \cap X_2$ and $t \in X_1 \setminus X_2$. Such a possibility can be check in $O(n^2)$ by Lemma 5.7 (3).
- $t \in X_1 \cap X_2$ and $s \in X_1 \setminus X_2$. Such a possibility is the directional dual of the preceding one. It can be tested in $O(n^2)$ by reversing all arcs and applying Lemma 5.7 (3).
- $\{s, t\} \subseteq X_1 \cap X_2$. Such a possibility can be check in $O(n^4)$ by Lemma 5.7 (4).

Since there are $O(n^2)$ pairs (s, t) and for each pair the procedure runs in $O(n^4)$, the algorithm runs in $O(n^6)$ time. \square

5.3 Computing related parameters when the inversion number is bounded

The aim of this subsection is to prove the following theorem.

Theorem 5.8. *Let γ be a parameter in τ, τ', ν . Given an oriented graph D with inversion number 1 and an integer k , it is NP-complete to decide whether $\gamma(D) \leq k$.*

Let D be a digraph. The **second subdivision** of D is the oriented graph $S_2(D)$ obtained from D by replacing every arc $a = uv$ by a directed path $P_a = (u, x_a, y_a, u)$ where x_a, y_a are two new vertices.

Proposition 5.9. *Let D be a digraph.*

- (i) $\text{inv}(S_2(D)) \leq 1$.
- (ii) $\tau'(S_2(D)) = \tau'(D)$, $\tau(S_2(D)) = \tau(D)$, and $\nu(S_2(D)) = \nu(D)$.

Proof. (i) Inverting the set $\bigcup_{a \in A(D)} \{x_a, y_a\}$ makes $S_2(D)$ acyclic. Indeed the x_a become sinks, the y_a become source and the other vertices form a stable set. Thus $\text{inv}(S_2(D)) = 1$.

(ii) There is a one-to-one correspondence between directed cycles in D and directed cycles in $S_2(D)$ (their second subdivision). Hence $\nu(S_2(D)) = \nu(D)$.

Moreover every cycle transversal S of D is also a cycle transversal of $S_2(D)$. So $\tau(S_2(D)) \leq \tau(D)$. Now consider a cycle transversal T . If x_a or y_a is in S for some $a \in A(D)$, then we can replace it by any end-vertex of a . Therefore, we may assume that $T \subseteq V(D)$, and so T is a cycle transversal of D . Hence $\tau(S_2(D)) = \tau(D)$.

Similarly, consider a cycle arc-transversal F of D . Then $F' = \{a \mid x_a y_a \in F\}$ is a cycle arc-transversal of $S_2(D)$. Conversely, consider a cycle arc-transversal F' of $S_2(D)$. Replacing each arc incident to x_a, y_a by $x_a y_a$ for each $a \in A(D)$, we obtain another cycle arc-transversal. So we may assume that $F' \subseteq \{x_a y_a \mid a \in A(D)\}$. Then $F = \{a \mid x_a y_a \in F'\}$ is a cycle arc-transversal of D . Thus $\tau'(S_2(D)) = \tau'(D)$. \square

Proof of Theorem 5.8. Since computing each of τ, τ', ν is NP-hard, Proposition 5.9 (ii) implies that computing each of τ, τ', ν is also NP-hard for second subdivisions of digraphs. As those oriented graphs have inversion number 1 (Proposition 5.9 (i)), computing each of τ, τ', ν is NP-hard for oriented graphs with inversion number 1. \square

Acknowledgement

The authors would like to thank Maurice Pouzet for suggesting the problem. There are very pleased to honour him on his 75th birthday.

This research was supported by the Independent Research Fund Denmark under grant number DFF 7014-00037B, and by the french Agence Nationale de la Recherche under contract Digraphs ANR-19-CE48-0013-01. This work was done while Joergen Bang-Jensen was visiting team Coati, I3S and INRIA Sophia Antipolis. Hospitality and financial support is gratefully acknowledged. Ce travail a bénéficié d'une aide du gouvernement français, gérée par l'Agence Nationale

de la Recherche au titre du projet Investissements d’Avenir UCAJEDI portant la référence no ANR-15-IDEX-01. This work was done while Jonas Costa Ferreira da Silva was spending his second year of PhD as “sandwich” in team Coati, I3S and INRIA Sophia Antipolis.

References

- [1] N. Alon. Ranking tournaments. *SIAM J. Discrete Math.*, 20:137–142, 2006.
- [2] J. Bang-Jensen and G. Gutin. *Digraphs: Theory, Algorithms and Applications*. Springer-Verlag, London, 2nd edition, 2009.
- [3] J. Bang-Jensen and M. Kriesell. On the problem of finding disjoint cycles and dicycles in a digraph. *Combinatorica*, 31:639–668, 2011.
- [4] J. Bang-Jensen and C. Thomassen. A polynomial algorithm for the 2-path problem for semicomplete digraphs. *SIAM J. Discrete Math.*, 5:366–376, 1992.
- [5] H. Belkhechine, M. Bouaziz, I. Boudabbous, and M. Pouzet. Inversions in tournaments. *Unpublished*.
- [6] H. Belkhechine, M. Bouaziz, I. Boudabbous, and M. Pouzet. Inversion dans les tournois. *Comptes Rendus Mathématique*, 348(13):703 – 707, 2010.
- [7] P. Charbit, S. Thomassé, and A. Yeo. The minimum feedback arc set problem is NP-hard for tournaments. *Combin. Probab. Comput.*, 16:1–4, 2007.
- [8] M. X. Goemans and D. P. Williamson. Primal-dual approximation algorithms for feedback problems in planar graphs. In W. H. Cunningham, S. T. McCormick, and M. Queyranne, editors, *Integer Programming and Combinatorial Optimization*, pages 147–161, Berlin, Heidelberg, 1996. Springer Berlin Heidelberg.
- [9] R. Karp. Reducibility among combinatorial problems. In *Complexity of computer computations (Proc. Symp., IBM Thomas J. Watson Res. Center, Yorktown Heights, N.Y., 1972)*, pages 85–103. Plenum, 1972.
- [10] W. McCuaig. Intercyclic digraphs. In N. Robertson and P. D. Seymour, editors, *Graph Structure Theory, Proceedings of a AMS-IMS-SIAM Joint Summer Research Conference on Graph Minors held June 22 to July 5, 1991, at the University of Washington, Seattle, USA*, volume 147 of *Contemporary Mathematics*, pages 203–245. American Mathematical Society, 1991.
- [11] A. Metzlar. *Minimum transversal of cycles in intercyclic digraphs*. PhD thesis, University of Waterloo, Ontario, Canada, 1989.
- [12] B. A. Reed, N. Robertson, P. D. Seymour, and R. Thomas. Packing directed circuits. *Combinatorica*, 16(4):535–554, 1996.
- [13] B. A. Reed and F. B. Shepherd. The gallai-younger conjecture for planar graphs. *Combinatorica*, 16(4):555–566, 1996.
- [14] E. Speckenmeyer. On feedback problems in digraphs. In *WG 1989*, volume 411 of *Lect. Notes Comput. Sci.*, pages 218–231. Springer, 1989.

Appendix: Dijoin of oriented graphs with inversion number 2

In this appendix, we give the proof of the following Theorem 3.6

Theorem 3.6. *Let L and R be strong digraphs such that $\text{inv}(L), \text{inv}(R) \geq 2$. Then $\text{inv}(L \rightarrow R) \geq 4$.*

Proof. Assume for a contradiction that there are two digraphs L and R such that $\text{inv}(L), \text{inv}(R) \geq 2$ and $\text{inv}(L \rightarrow R) = 3$. By Lemma 2.4 and Proposition 2.1, we can assume that L and R are tournaments.

By Theorem b3.4, $\text{inv}(L \rightarrow R) \geq 3$. Assume for a contradiction that $\text{inv}(L \rightarrow R) = 3$. Let (X_1, X_2, X_3) be a decycling sequence of $D = L \rightarrow R$ and denote the resulting acyclic (transitive) tournament by T . We will use the following notation. Below and in the whole proof, whenever we use subscripts i, j, k together we have $\{i, j, k\} = \{1, 2, 3\}$.

- $X_i^L = X_i \cap V(L), X_i^R = X_i \cap V(R)$ for all $i \in [3]$.
- $Z^L = V(L) \setminus (X_1^L \cup X_2^L \cup X_3^L)$ and $Z^R = V(R) \setminus (X_1^R \cup X_2^R \cup X_3^R)$
- $X_{123}^L = X_1^L \cap X_2^L \cap X_3^L, X_{123}^R = X_1^R \cap X_2^R \cap X_3^R$.
- $X_{ij-k}^L = (X_i^L \cap X_j^L) \setminus X_k^L$ and $X_{ij-k}^R = (X_i^R \cap X_j^R) \setminus X_k^R$.
- $X_{i-jk}^L = X_i^L \setminus (X_j^L \cup X_k^L)$ and $X_{i-jk}^R = X_i^R \setminus (X_j^R \cup X_k^R)$.

For any two (possibly empty) sets Q, W , we write $Q \rightarrow W$ to indicate that every $q \in Q$ has an arc to every $w \in W$. Unless otherwise specified, we are always referring to the arcs of T below. When we refer to arcs of the original digraph we will use the notation $u \Rightarrow v$, whereas we use $u \rightarrow v$ for arcs in T .

Claim A: $X_i^L, X_i^R \neq \emptyset$ for all $i \in [3]$.

Proof. Suppose w.l.o.g. that $X_1^R = \emptyset$ and let $D' = \text{Inv}(D; X_1)$. Then D' contains $C_3 \rightarrow R$ as an induced subdigraph since reversing X_1^L does not make L acyclic so there is still a directed 3-cycle (by Moon's theorem). \diamond

Claim B: *In T the following holds, implying that at least one of the involved sets is empty (as T is acyclic).*

- (a) $X_{123}^R \rightarrow X_{123}^L \rightarrow X_{ij-k}^R \rightarrow X_{ik-j}^L \rightarrow X_{123}^R$.
- (b) $X_{ij-k}^L \rightarrow X_{ij-k}^R \rightarrow X_{ik-j}^L \rightarrow X_{ik-j}^R \rightarrow X_{ij-k}^L$.

Proof. This follows from the fact that an arc of D is inverted if and only if it belongs to an odd number of the sets X_1, X_2, X_3 . \diamond

Claim C: *For all $i \neq j$, we have $X_i^L \neq X_j^L$ and $X_i^R \neq X_j^R$.*

Proof. Suppose this is not true, then without loss of generality $X_3^L = X_2^L$ but this contradicts that (X_1^L, X_2^L, X_3^L) is a decycling sequence of L as inverting X_2^L and X_3^L leaves every arc unchanged and we have $\text{inv}(L) = 2$. \diamond

Now we are ready to obtain a contradiction to the assumption that (X_1, X_2, X_3) is a decycling sequence for $D = L \rightarrow R$. We divide the proof into five cases. In order to increase readability, we will emphasize partial conclusions in **blue**, assumptions in **orange**, and indicate consequences of assumptions in **red**.

Case 1: $X_{i-jk}^L = \emptyset = X_{i-jk}^R$ for all i, j, k .

By Claim C, at least two of the sets $X_{12-3}^L, X_{13-2}^L, X_{23-1}^L$ are non-empty and at least two of the sets $X_{12-3}^R, X_{13-2}^R, X_{23-1}^R$ are non-empty. Without loss of generality, $X_{12-3}^L, X_{13-2}^L \neq \emptyset$. Now, by Claim B (b), implies that one of X_{12-3}^R, X_{13-2}^R must be empty. By interchanging the names of X_2, X_3 if necessary, we may assume that $X_{13-2}^R = \emptyset$ and hence, by Claim C, $X_{12-3}^R, X_{23-1}^R \neq \emptyset$. By Claim B (a), this implies $X_{23-1}^L = \emptyset$. Now

$X_{23-1}^R \rightarrow X_{12-3}^L \rightarrow X_{12-3}^R$, so $X_{23-1}^R \rightarrow X_{13-2}^R$. As $X_{12-3}^L \rightarrow X_{12-3}^R \rightarrow X_{13-2}^L$, we must have $X_{12-3}^L \rightarrow X_{13-2}^L$. By Claim B (a), $X_{123}^L \rightarrow X_{12-3}^R \rightarrow X_{13-2}^L \rightarrow X_{123}^R \rightarrow X_{123}^L$, so one of X_{123}^L and X_{123}^R is empty. W.l.o.g. we may assume $X_{123}^R = \emptyset$. As R is strong and X_{23-1}^R dominates X_{12-3}^R in R (these arcs are reversed by X_2), we must have $Z^R \neq \emptyset$. Moreover the arcs incident to Z^R are not reversed, so the set Z^R has an out-neighbour in $X_{12-3}^R \cup X_{23-1}^R$. But $X_{12-3}^R \cup X_{23-1}^R \rightarrow X_{13-2}^L \rightarrow Z^R$ so T has a directed 3-cycle, contradiction. This completes the proof of Case 1.

Case 2: Exactly one of $X_{1-23}^L, X_{2-13}^L, X_{3-12}^L, X_{1-23}^R, X_{2-13}^R, X_{3-12}^R$ is non-empty.

By reversing all arcs and switching the names of L and R if necessary, we may assume w.l.o.g that $X_{1-23}^L \neq \emptyset$. As $X_2^R \neq X_3^R$ we have $X_{12-3}^R \cup X_{13-2}^R \neq \emptyset$. By symmetry, we can assume that $X_{12-3}^R \neq \emptyset$.

Suppose for a contradiction that $X_{23-1}^R = \emptyset$. Then Claims A and C imply $X_{13-2}^R \neq \emptyset$. Now, by Claim B (b), one of X_{12-3}^L, X_{13-2}^L is empty. By symmetry, we can assume $X_{13-2}^L = \emptyset$. Now, by Claim C, $X_2^L \neq X_3^L$, so $X_{12-3}^L \neq \emptyset$. Note that $X_{12-3}^L \rightarrow X_{12-3}^R \rightarrow X_{1-23}^L$, thus $X_{12-3}^L \rightarrow X_{1-23}^L$ because T is acyclic. We also have $X_{123}^L \rightarrow X_{12-3}^L$ as $X_{123}^L \rightarrow X_{13-2}^R \rightarrow X_{12-3}^L$, and $X_{12-3}^L \rightarrow X_{23-1}^L$ as $X_{12-3}^L \rightarrow X_{12-3}^R \rightarrow X_{23-1}^L$. This implies that in L all arcs between X_{12-3}^L and $X_{23-1}^L \cup X_{123}^L \cup X_{1-23}^L$ are entering X_{12-3}^L (the arcs between X_{123}^L and X_{12-3}^L were reversed twice and those between $X_{1-23}^L \cup X_{23-1}^L$ and X_{12-3}^L were reversed once). Hence, as L is strong, we must have an arc uz from X_{12-3}^L to Z^L . But $Z^L \rightarrow X_{13-2}^R \rightarrow X_{12-3}^L$ so together with uz we have a directed 3-cycle in T , contradiction. Hence $X_{23-1}^R \neq \emptyset$.

Observe that $X_{12-3}^R \cup X_{13-2}^R \rightarrow X_{23-1}^R$ as $X_{12-3}^R \cup X_{13-2}^R \rightarrow X_{1-23}^L \rightarrow X_{23-1}^R$.

If $X_{12-3}^L \neq \emptyset$, then $X_{23-1}^R \rightarrow X_{12-3}^L \rightarrow X_{12-3}^R \rightarrow X_{23-1}^R$, a contradiction. So $X_{12-3}^L = \emptyset$. But $X_2^L \neq X_3^L$ by Claim C. Thus $X_{13-2}^L \neq \emptyset$. As $X_{23-1}^R \rightarrow X_{13-2}^L \rightarrow X_{123}^R$, we have $X_{23-1}^R \rightarrow X_{123}^R$. This implies that in R all the arcs between X_{23-1}^R and $X_{13-2}^R \cup X_{123}^R \cup X_{12-3}^R$ are leaving X_{23-1}^R . So as R is strong there must be an arc in R from Z^R to X_{23-1}^R . This arc is not reversed (in fact reversed twice), so it is also an arc in T . But since $X_{23-1}^R \rightarrow X_{13-2}^L \rightarrow Z^R$, this arc is in a directed 3-cycle, a contradiction. This completes Case 2.

Case 3: Exactly one of $X_{1-23}^L, X_{2-13}^L, X_{3-12}^L$ is non-empty and exactly one of $X_{1-23}^R, X_{2-13}^R, X_{3-12}^R$ is non-empty.

By symmetry we can assume $X_{1-23}^L \neq \emptyset$.

Subcase 3.1: $X_{1-23}^R \neq \emptyset$.

By Claim C, $X_2^L \neq X_3^L$, so one of X_{12-3}^L and X_{13-2}^L is non-empty. By symmetry we may assume $X_{12-3}^L \neq \emptyset$.

Suppose $X_{12-3}^R \neq \emptyset$. Then $X_{23-1}^R = \emptyset$ as $X_{1-23}^L \rightarrow X_{23-1}^R \rightarrow X_{12-3}^L \rightarrow X_{12-3}^R \rightarrow X_{1-23}^L$, and $X_{23-1}^R = \emptyset$ as $X_{1-23}^R \rightarrow X_{12-3}^L \rightarrow X_{12-3}^R \rightarrow X_{23-1}^R \rightarrow X_{1-23}^R$.

By Claim B (b), one of X_{13-2}^L, X_{13-2}^R is empty. By symmetry, we may assume $X_{13-2}^R = \emptyset$.

Observe that $V(R) \setminus Z^R = X_{123}^R \cup X_{12-3}^R \cup X_{1-23}^R$, so $V(R) \setminus Z^R \rightarrow X_{1-23}^L \rightarrow Z^R$, so $V(R) \setminus Z^R \rightarrow Z^R$. But all the arcs incident to Z^R are not inverted, so in R , there is no arc from Z^R to $V(R) \setminus Z^R$. Since R is strong, $Z^R = \emptyset$.

Now $X_{1-23}^R \rightarrow X_{12-3}^R \cup X_{123}^R$ because $X_{1-23}^R \rightarrow X_{12-3}^L \rightarrow X_{12-3}^R \cup X_{123}^R$. But all the arcs between X_{1-23}^R and $X_{12-3}^R \cup X_{123}^R = V(R) \setminus X_{1-23}^R$ are inverted from R to T . Hence in R , no arcs leaves X_{1-23}^R in R , a contradiction to R being strong.

Hence $X_{12-3}^R = \emptyset$. As $X_2^R \neq X_3^R$ this implies $X_{13-2}^R \neq \emptyset$.

Suppose that $X_{23-1}^R = \emptyset$, then $X_{123}^R \neq \emptyset$ because $X_2^R \neq \emptyset$ by Claim A. Furthermore $X_{13-2}^R \rightarrow X_{123}^R$ as $X_{13-2}^R \rightarrow X_{12-3}^L \rightarrow X_{123}^R$, and $X_{12-3}^L \rightarrow X_{1-23}^L$ as $X_{12-3}^L \rightarrow X_{123}^R \rightarrow X_{1-23}^L$. This implies that $X_{123}^L = \emptyset$ as $X_{123}^L \rightarrow X_{13-2}^R \rightarrow X_{123}^R \rightarrow X_{123}^L$.

Since L is strong, there must be an arc uv leaving X_{12-3}^L in L . But v cannot be in X_{1-23}^L since all vertices of this set dominate X_{12-3}^L in L . Moreover v cannot be in Z^L for otherwise (u, v, w, u) would be a directed 3-cycle in T for any $w \in X_{1-23}^R$ since $Z^L \rightarrow X_{1-23}^R \rightarrow X_{12-3}^L$. Hence $v \in X_{13-2}^L \cup X_{23-1}^L$, so $X_{13-2}^L \cup X_{23-1}^L \neq \emptyset$.

As $X_{13-2}^L \rightarrow X_{13-2}^R \rightarrow X_{23-1}^L \rightarrow X_{1-23}^R \rightarrow X_{13-2}^L$, precisely one of X_{13-2}^L, X_{23-1}^L is non-empty.

If $X_{13-2}^L \neq \emptyset$ and $X_{23-1}^L = \emptyset$, then $X_{13-2}^L \rightarrow X_{13-2}^R \rightarrow X_{1-23}^L \cup X_{12-3}^L$ implies that $X_{13-2}^L \rightarrow X_{1-23}^L \cup X_{12-3}^L$. As $d_L^+(X_{13-2}^L) > 0$ there exists $z \in Z^L$ such that there is an arc uz from X_{13-2}^L to Z^L , but then $z \rightarrow X_{1-23}^R \rightarrow u \rightarrow z$ is a contradiction. Hence $X_{13-2}^L = \emptyset$ and $X_{23-1}^L \neq \emptyset$. Then $X_{23-1}^L \rightarrow X_1^L$ as $X_{23-1}^L \rightarrow X_{1-23}^R \rightarrow X_1^L$.

Note that $Z^L = \emptyset$ as every vertex in $V(L) \setminus Z^L$ has an in-neighbour in $V(R)$ in T , implying that there can be no arc from $V(L) \setminus Z^L$ to Z^L in L . Thus $V(L) = X_{1-23}^L \cup X_{12-3}^L \cup X_{23-1}^L$ where each of these sets induces an acyclic subdigraph of L and we have $X_{1-23}^L \Rightarrow X_{12-3}^L \Rightarrow X_{23-1}^L \Rightarrow X_{1-23}^L$ in L . But now inverting the set $X_{1-23}^L \cup X_{23-1}^L$ makes L acyclic, a contradiction to $\text{inv}(L) = 2$. Thus $X_{23-1}^R \neq \emptyset$.

Suppose $X_{23-1}^L = \emptyset$. As above $Z^L = \emptyset$, so $V(L) = X_1^L$. As $X_{1-23}^L \rightarrow X_{23-1}^R \rightarrow X_{12-3}^L \cup X_{13-2}^L$ we have $X_{1-23}^L \rightarrow X_{12-3}^L \cup X_{13-2}^L$. Thus, using $d_L^+(X_{1-23}^L) > 0$, we get $X_{123}^L \neq \emptyset$. As $X_{123}^R \rightarrow X_{123}^L \rightarrow X_{23-1}^R \rightarrow X_{12-3}^L \rightarrow X_{123}^R$, we have $X_{123}^R = \emptyset$. Moreover $X_1^R \rightarrow X_{23-1}^R$ because $X_1^R \rightarrow X_{1-23}^L \rightarrow X_{23-1}^R$. We also have $X_{1-23}^R \rightarrow X_{13-2}^R$ as $X_{1-23}^R \rightarrow X_{123}^L \rightarrow X_{13-2}^R$. Now $V(R) \setminus Z^R = X_{1-23}^R \cup X_{13-2}^R \cup X_{23-1}^R \rightarrow X_{12-3}^L \rightarrow Z^R$. Thus $Z^R = \emptyset$ and $V(R) = X_{1-23}^R \cup X_{13-2}^R \cup X_{23-1}^R$ where each of these sets induces an acyclic digraph in R and $X_{1-23}^R \Rightarrow X_{23-1}^R \Rightarrow X_{13-2}^R \Rightarrow X_{1-23}^R$ in D . But then inverting $X_{1-23}^R \cup X_{23-1}^R$ we make R acyclic, a contradiction to $\text{inv}(R) = 2$. Thus $X_{23-1}^L \neq \emptyset$.

Therefore $X_{13-2}^L = \emptyset$ as $X_{13-2}^L \rightarrow X_{13-2}^R \rightarrow X_{23-1}^L \rightarrow X_{23-1}^R \rightarrow X_{13-2}^L$. As $X_{1-23}^L \rightarrow X_{23-1}^R \rightarrow X_{12-3}^L$ we have $X_{1-23}^L \rightarrow X_{12-3}^L$; As $X_{23-1}^L \rightarrow X_{1-23}^R \rightarrow X_{1-23}^L \cup X_{12-3}^L$ we have $X_{23-1}^L \rightarrow X_{1-23}^L \cup X_{12-3}^L$; As $X_{1-23}^R \rightarrow X_{1-23}^L \rightarrow X_{23-1}^R$ we have $X_{1-23}^R \rightarrow X_{23-1}^R$; as $X_{13-2}^R \rightarrow X_{23-1}^L \rightarrow X_{1-23}^R \cup X_{23-1}^R$ we have $X_{13-2}^R \rightarrow X_{1-23}^R \cup X_{23-1}^R$.

As every vertex in $V(R) \setminus Z^R$ has an out-neighbour in $V(L)$, we derive as above $Z^R = \emptyset$. Similarly, as every vertex in $V(L) \setminus Z^L$ has in-neighbour in $V(R)$, we get $Z^L = \emptyset$. Next observe that at least one of the sets X_{123}^R, X_{123}^L must be empty as $X_{123}^R \rightarrow X_{123}^L \rightarrow X_{23-1}^R \rightarrow X_{12-3}^L \rightarrow X_{123}^R$. If $X_{123}^R = \emptyset$ then $V(R) = X_{1-23}^R \cup X_{13-2}^R \cup X_{23-1}^R$ where each of these sets induces an acyclic subtournament of R and $X_{1-23}^R \Rightarrow X_{23-1}^R \Rightarrow X_{13-2}^R$ and $X_{1-23}^R \Rightarrow X_{13-2}^R$. Thus R is acyclic, contradicting $\text{inv}(R) = 2$. So $X_{123}^R \neq \emptyset$ and $X_{123}^L = \emptyset$. As above we obtain a contradiction by observing that L is acyclic, contradicting $\text{inv}(L) = 2$. This completes the proof of Subcase 3.1.

Subcase 3.2 $X_{1-23}^R = \emptyset$.

By symmetry, we can assume $X_{2-13}^R = \emptyset$ and $X_{3-12}^R \neq \emptyset$. Hence $X_{1-23}^L \rightarrow X_3^L$ because $X_{1-23}^L \rightarrow X_{3-12}^R \rightarrow X_3^L$, and $X_1^R \rightarrow X_{3-12}^R$ because $X_1^R \rightarrow X_{1-23}^L \rightarrow X_{3-12}^R$. Note that one of X_{13-2}^L, X_{13-2}^R is empty since $X_{13-2}^L \rightarrow X_{13-2}^R \rightarrow X_{1-23}^L \rightarrow X_{3-12}^R \rightarrow X_{13-2}^L$. By symmetry we can assume that $X_{13-2}^L = \emptyset$. By Claim C, $X_2^L \neq X_3^L$, so $X_{12-3}^L \neq \emptyset$.

Suppose first that $X_{123}^R \neq \emptyset$. Then $X_{23-1}^L = \emptyset$ since $X_{23-1}^L \rightarrow X_{123}^R \rightarrow X_{1-23}^L \rightarrow X_{23-1}^L$. Now, by Claim A, $X_3^L \neq \emptyset$ so $X_{123}^L \neq \emptyset$. Now $X_{123}^L \rightarrow X_{13-2}^R \rightarrow X_{1-23}^L \rightarrow X_{123}^L$, so $X_{13-2}^R = \emptyset$. Furthermore, $X_{23-1}^R \rightarrow X_{12-3}^L \rightarrow X_{123}^R \rightarrow X_{1-23}^L \rightarrow X_{23-1}^R$ so $X_{23-1}^R = \emptyset$. Therefore $X_1^R = X_2^R$, a contradiction to Claim C. Thus $X_{123}^R = \emptyset$.

Next suppose $X_{123}^L \neq \emptyset$. Then $X_{12-3}^R = \emptyset$ because $X_{12-3}^R \rightarrow X_{3-12}^R \rightarrow X_{123}^L \rightarrow X_{12-3}^R$. By Claim A, $X_1^R, X_2^R \neq \emptyset$, so $X_{13-2}^R \neq \emptyset$ and $X_{23-1}^R \neq \emptyset$. As $X_{13-2}^R \rightarrow X_{1-23}^L \rightarrow X_{3-12}^R \cup X_{23-1}^R$ we have $X_{13-2}^R \rightarrow X_{3-12}^R \cup X_{23-1}^R$.

Since $d_R^+(X_{13-2}^R) > 0$ we have $Z^R \neq \emptyset$. However, there can be no arcs from Z^R to $X_3^R = V(R) \setminus Z^R$, because $X_3^R \rightarrow X_{123}^L \rightarrow Z^R$. This contradicts the fact that R is strong. Thus $X_{123}^L = \emptyset$.

By Claim A, $X_3^L \neq \emptyset$, so $X_{23-1}^L \neq \emptyset$. Thus $X_{23-1}^R = \emptyset$ because $X_{23-1}^R \rightarrow X_{12-3}^L \rightarrow X_{3-12}^R \rightarrow X_{23-1}^L \rightarrow X_{23-1}^R$. By Claim A, $X_2^R \neq \emptyset$ so $X_{12-3}^R \neq \emptyset$. By Claim C, $X_1^R \neq X_2^R$, so $X_{13-2}^R \neq \emptyset$. As $X_{12-3}^L \rightarrow X_{12-3}^R \rightarrow X_{1-23}^L \cup X_{23-1}^L$, we have $X_{12-3}^L \rightarrow X_{1-23}^L \cup X_{23-1}^L$. Thus the fact that $d_L^+(X_{12-3}^L) > 0$ implies that there is an arc vz from X_{12-3}^L to Z^L . But then for any $u \in X_{13-2}^R$, (u, v, z, u) is directed 3-cycle, a contradiction.

This completes Subcase 3.2.

Case 4: All three of $X_{1-23}^L, X_{2-13}^L, X_{3-12}^L$ or all three of $X_{1-23}^R, X_{2-13}^R, X_{3-12}^R$ are non-empty.

By symmetry, we can assume that $X_{1-23}^L, X_{2-13}^L, X_{3-12}^L \neq \emptyset$. There do not exist $i, j \in [3]$ such that $X_i^R \setminus X_j^R, X_j^R \setminus X_i^R \neq \emptyset$, for otherwise $X_{i-jk}^L \rightarrow (X_j^R \setminus X_i^R) \rightarrow X_{j-ik}^L \rightarrow (X_i^R \setminus X_j^R) \rightarrow X_{i-jk}^L$, a contradiction. Hence we may assume by symmetry that $X_3^R \setminus X_1^R, X_3^R \setminus X_2^R, X_2^R \setminus X_3^R = \emptyset$. This implies that $X_2^R = X_{123}^R, X_3^R = X_{123}^R \cup X_{13-2}^R$ and $X_1^R = X_{123}^R \cup X_{13-2}^R \cup X_{1-23}^R$. Moreover, $X_{1-23}^R, X_{123}^R, X_{13-2}^R \neq \emptyset$ by Claim C. As $X_3^R \rightarrow X_{3-12}^L \rightarrow X_{1-23}^R$ we have $X_3^R \rightarrow X_{1-23}^R$, so since $d_R^-(X_{1-23}^R) > 0$ we must have an arc from Z^R to X_{1-23}^R and now $X_{1-23}^R \rightarrow X_{1-23}^L \rightarrow Z^R$ gives a contradiction. This completes Case 4.

Case 5: Exactly two of $X_{1-23}^L, X_{2-13}^L, X_{3-12}^L$ or two of $X_{1-23}^R, X_{2-13}^R, X_{3-12}^R$ are non-empty.

By symmetry we can assume that $X_{1-23}^L, X_{2-13}^L \neq \emptyset$ and $X_{3-12}^L = \emptyset$.

Subcase 5.1: $X_{1-23}^R, X_{2-13}^R, X_{3-12}^R = \emptyset$.

As $X_{1-23}^L \rightarrow X_{23-1}^R \rightarrow X_{2-13}^L \rightarrow X_{13-2}^R \rightarrow X_{1-23}^L$, one of X_{13-2}^R, X_{23-1}^R is empty. By symmetry we may assume that $X_{23-1}^R = \emptyset$. By Claim C, $X_1^R \neq X_2^R$ and $X_1^R \neq X_3^R$, so $X_{13-2}^R \neq \emptyset$ and $X_{12-3}^R \neq \emptyset$. Now $V(R) \setminus Z^R = X_1^R \rightarrow X_{1-23}^L \rightarrow Z^R$, thus there is no arc leaving Z^R . As R is strong, we get $Z^R = \emptyset$.

As $X_{12-3}^R \rightarrow X_{2-13}^L \rightarrow X_{13-2}^R$, we have $X_{12-3}^R \rightarrow X_{13-2}^R$. Hence as R is strong, necessarily $X_{123}^R \neq \emptyset$. If $X_{123}^L \neq \emptyset$, then $X_{123}^R \rightarrow X_{12-3}^R \cup X_{13-2}^R$ as $X_{123}^R \rightarrow X_{123}^L \rightarrow X_{12-3}^R \cup X_{13-2}^R$. This contradicts the fact that R is strong since $d_R^+(X_{123}^R) = 0$. Hence $X_{123}^L = \emptyset$. By Claim A, $X_3^L \neq \emptyset$, so $X_{13-2}^L \cup X_{23-1}^L \neq \emptyset$.

Since $X_{123}^R \rightarrow X_{2-13}^L \rightarrow X_{13-2}^R$, we have $X_{123}^R \rightarrow X_{13-2}^R$. We also have $X_{12-3}^R \rightarrow X_{123}^R$ because $X_{12-3}^R \rightarrow X_{13-2}^L \cup X_{23-1}^L \rightarrow X_{123}^R$. Hence $V(R) = X_{12-3}^R \cup X_{13-2}^R \cup X_{123}^R$ where each of these sets induces an acyclic subtournament of R and $X_{13-2}^R \Rightarrow X_{12-3}^R \Rightarrow X_{123}^R \Rightarrow X_{13-2}^R$. Thus inverting $X_{12-3}^R \cup X_{13-2}^R$ makes R acyclic, contradicting $\text{inv}(R) = 2$.

This completes Subcase 5.1

Subcase 5.2: $X_{1-23}^R \neq \emptyset$ and $X_{2-13}^R \cup X_{3-12}^R = \emptyset$.

We first observe that since $X_{2-13}^L \cup X_{23-1}^L \rightarrow X_{1-23}^R \rightarrow X_1^L$ we can conclude that $X_{2-13}^L \rightarrow X_1^L$ and $X_{23-1}^L \rightarrow X_1^L$. As $X_{23-1}^R \rightarrow X_{2-13}^L \rightarrow X_{1-23}^R \rightarrow X_{23-1}^R$, we have $X_{23-1}^R = \emptyset$. Now $V(R) \setminus Z^R = X_1^R$ and $X_1^R \rightarrow X_{1-23}^L \rightarrow Z^R$. So $V(R) \setminus Z^R \rightarrow Z^R$. Since R is strong, $Z^R = \emptyset$. Now Claims A and C imply that at least two of the sets $X_{13-2}^R, X_{123}^R, X_{12-3}^R$ are non-empty. This implies that every vertex of $V(L)$ has an in-neighbour in $V(R)$ (as $X_{1-23}^R \rightarrow X_1^L, X_{13-2}^R \cup X_{12-3}^R \rightarrow X_{23-1}^L$ and $X_2^R \rightarrow X_{2-13}^L$) so we must have $Z^L = \emptyset$.

Suppose first that $X_{12-3}^R = \emptyset$. By Claim A, $X_2^R \neq \emptyset$, so $X_{123}^R \neq \emptyset$. Moreover, by Claim C, $X_2^R \neq X_3^R$, so $X_{13-2}^R \neq \emptyset$. Since $X_{12-3}^L \cup X_{13-2}^L \rightarrow X_{123}^R \rightarrow X_{2-13}^L \rightarrow X_{12-3}^L \cup X_{13-2}^L$ we have $X_{12-3}^L \cup X_{13-2}^L = \emptyset$. If $X_{23-1}^L \neq \emptyset$, then $X_{123}^L = \emptyset$ as $X_{23-1}^L \rightarrow X_{123}^L \rightarrow X_{13-2}^R \rightarrow X_{23-1}^L$ and we have $X_{2-13}^L \rightarrow X_{23-1}^L$ as $X_{2-13}^L \rightarrow X_{13-2}^R \rightarrow X_{23-1}^L$. Now we see that $d_L^-(X_{23-1}^L) = 0$, a contradiction. Hence $X_{23-1}^L = \emptyset$ and $X_{123}^L \neq \emptyset$ because $X_3^L \neq \emptyset$ by Claim A. Moreover $X_{123}^L \rightarrow X_{1-23}^R$ because $X_{123}^L \rightarrow X_{13-2}^R \rightarrow X_{1-23}^R$. Now $V(L) = X_{1-23}^L \cup X_{2-13}^L \cup X_{123}^L$ where each of these sets induces an acyclic subdigraph in L and $X_{1-23}^L \Rightarrow X_{123}^L \Rightarrow X_{2-13}^L \Rightarrow X_{1-23}^L$. Then inverting the set

$X_{1-23}^L \cup X_{2-13}^L$ makes L acyclic, a contradiction to $\text{inv}(L) = 2$. Thus $X_{12-3}^R \neq \emptyset$.

Note that $X_{12-3}^R \rightarrow X_{1-23}^R \cup X_{13-2}^R$ as $X_{12-3}^R \rightarrow X_{2-13}^L \rightarrow X_{1-23}^R \cup X_{13-2}^R$. Thus $X_{123}^L = \emptyset$ because $X_{123}^L \rightarrow X_{12-3}^R \rightarrow X_{1-23}^R \rightarrow X_{123}^L$. Furthermore the fact that $d_R^+(X_{12-3}^R) > 0$ implies that $X_{123}^R \neq \emptyset$ and that there is at least one arc from X_{12-3}^R to X_{123}^R in T (and in R). We saw before that $X_{12-3}^R \rightarrow X_{1-23}^R$ and by the same reasoning $X_{123}^R \rightarrow X_{1-23}^R$, hence, as $Z^R = \emptyset$ and $d_R^-(X_{1-23}^R) > 0$, there is at least one arc from X_{1-23}^R to X_{13-2}^R . Hence $X_{13-2}^R \neq \emptyset$ and $X_{23-1}^R = \emptyset$ as $X_{13-2}^R \rightarrow X_{23-1}^L \rightarrow X_{1-23}^R$. We have $X_{12-3}^L = \emptyset$ since $X_{12-3}^L \rightarrow X_{123}^R \rightarrow X_{2-13}^L \rightarrow X_{1-23}^R \rightarrow X_{12-3}^L$. Finally, as $X_{2-13}^L \rightarrow X_{1-23}^R \rightarrow X_1^L$ we have $X_{2-13}^L \rightarrow X_1^L$. But now $d_L^+(X_1^L) = 0$ (recall that $Z^L = \emptyset$), a contradiction. This completes Subcase 5.2

Subcase 5.3: $X_{3-12}^R \neq \emptyset$ and $X_{1-23}^R \cup X_{2-13}^R = \emptyset$.

As $X_{23-1}^R \rightarrow X_{2-13}^L \rightarrow X_{13-2}^R \rightarrow X_{1-23}^L \rightarrow X_{23-1}^R$ one of the sets X_{13-2}^R, X_{23-1}^R must be empty. By symmetry we may assume that $X_{23-1}^R = \emptyset$.

Suppose first that $X_{12-3}^R = \emptyset$. Then, by Claim A, $X_2^R \neq \emptyset$, so $X_{123}^R \neq \emptyset$, and by Claim C, $X_1^R \neq X_2^R$, so $X_{13-2}^R \neq \emptyset$. Now $X_{123}^L = \emptyset$ because $X_{123}^L \rightarrow X_{13-2}^R \rightarrow X_{1-23}^L \rightarrow X_{3-12}^R \rightarrow X_{123}^L$. As $X_{123}^R \rightarrow X_{2-13}^L \rightarrow X_{13-2}^R \cup X_{3-12}^R$, we have $X_{123}^R \rightarrow X_{13-2}^R \cup X_{3-12}^R$. Next we observe that $X_{13-2}^L = \emptyset$ since $X_{13-2}^L \rightarrow X_{123}^R \rightarrow X_{3-12}^R \rightarrow X_{13-2}^L$. Now, as $X_3^L \neq \emptyset$ by Claim C, we have $X_{23-1}^L \neq \emptyset$ but that contradicts that $X_{23-1}^L \rightarrow X_{123}^R \rightarrow X_{3-12}^R \rightarrow X_{23-1}^L$. So we must have $X_{12-3}^R \neq \emptyset$.

First observe that $X_{123}^L = \emptyset$ as $X_{123}^L \rightarrow X_{12-3}^R \rightarrow X_{1-23}^L \rightarrow X_{3-12}^R \rightarrow X_{123}^L$. As $X_1^R \neq X_2^R$ by Claim C, we have $X_{13-2}^R \neq \emptyset$. Now $X_{13-2}^L = \emptyset$ as $X_{13-2}^L \rightarrow X_{13-2}^R \rightarrow X_{1-23}^L \rightarrow X_{3-12}^R \rightarrow X_{13-2}^L$. As $X_3^L \neq \emptyset$ by Claim A, we have $X_{23-1}^L \neq \emptyset$. Since $X_{12-3}^R \rightarrow X_{12-3}^L \rightarrow X_{2-13}^L \rightarrow X_{13-2}^R \rightarrow X_{12-3}^R$ we have $X_{12-3}^L = \emptyset$. As $X_{1-23}^L \rightarrow X_{3-12}^R \rightarrow X_{23-1}^L$, we have $X_{1-23}^L \rightarrow X_{23-1}^L$. Moreover $X_{2-13}^L \rightarrow X_{13-2}^R \rightarrow X_{23-1}^L \cup X_{1-23}^L$ implies $X_{2-13}^L \rightarrow X_{23-1}^L \cup X_{1-23}^L$. We also have $Z^L = \emptyset$ since every vertex in $X_{1-23}^L \cup X_{23-1}^L \cup X_{2-13}^L$ has an in-neighbour in R , implying that there can be no arc entering Z^L . Now $V(L) = X_{1-23}^L \cup X_{23-1}^L \cup X_{2-13}^L$ where each of these sets induces a transitive subtournament in L and $X_{1-23}^L \Rightarrow X_{23-1}^L \Rightarrow X_{2-13}^L \Rightarrow X_{1-23}^L$. However this implies that inverting $X_{1-23}^L \cup X_{2-13}^L$ makes L acyclic, a contradiction to $\text{inv}(L) = 2$. This completes the proof of Subcase 5.3.

Subcase 5.4: $X_{1-23}^R, X_{2-13}^R \neq \emptyset$ and $X_{3-12}^R = \emptyset$.

This case is trivial as $X_{1-23}^L \rightarrow X_{2-13}^R \rightarrow X_{2-13}^L \rightarrow X_{1-23}^R \rightarrow X_{1-23}^L$ contradicts that T is acyclic.

By symmetry the only remaining case to consider is the following.

Subcase 5.5: $X_{1-23}^R, X_{3-12}^R \neq \emptyset$ and $X_{2-13}^R = \emptyset$.

As $X_{23-1}^L \rightarrow X_{1-23}^R \rightarrow X_{1-23}^L \rightarrow X_{3-12}^R \rightarrow X_{23-1}^L$ we have $X_{23-1}^L = \emptyset$ and as $X_{23-1}^R \rightarrow X_{2-13}^L \rightarrow X_{1-23}^R \rightarrow X_{1-23}^L \rightarrow X_{23-1}^R$ we have $X_{23-1}^R = \emptyset$. Note that every vertex in $V(L)$ has an in-neighbour in $V(R)$ (as $X_{1-23}^R \rightarrow X_{1-23}^L$ and $X_2^R \rightarrow X_{2-13}^L$) and every vertex in $V(R)$ has an out-neighbour in $V(L)$ (as $X_1^R \rightarrow X_{1-23}^L$ and $X_{3-12}^R \rightarrow X_3^L$). This implies that $Z^L = \emptyset$ and $Z^R = \emptyset$. At least one of X_{13-2}^L, X_{13-2}^R is empty as $X_{13-2}^L \rightarrow X_{13-2}^R \rightarrow X_{1-23}^L \rightarrow X_{3-12}^R \rightarrow X_{13-2}^L$ and at least one of X_{12-3}^L, X_{12-3}^R is empty as $X_{12-3}^L \rightarrow X_{12-3}^R \rightarrow X_{2-13}^L \rightarrow X_{1-23}^R \rightarrow X_{12-3}^L$.

Suppose first that $X_{12-3}^R = \emptyset = X_{13-2}^R$. Then $X_2^R \neq \emptyset$ by Claim A, so $X_{123}^R \neq \emptyset$.

Moreover $X_{123}^R \rightarrow X_{1-23}^R \cup X_{3-12}^R$ because $X_{123}^R \rightarrow X_{2-13}^L \rightarrow X_{1-23}^R \cup X_{3-12}^R$. This implies that $d_R^+(X_{123}^R) = 0$, a contradiction.

Suppose next that $X_{12-3}^L = \emptyset = X_{13-2}^L$. Then $X_3^L \neq \emptyset$ by Claim A, so $X_{123}^L \neq \emptyset$. Moreover $X_{1-23}^L \cup X_{2-13}^L \rightarrow X_{123}^L$ as $X_{1-23}^L \cup X_{2-13}^L \rightarrow X_{3-12}^R \rightarrow X_{123}^L$. This implies that $d_L^-(X_{123}^L) = 0$, a contradiction.

Now assume that $X_{12-3}^R = \emptyset = X_{13-2}^L$ and $X_{13-2}^R \neq \emptyset \neq X_{12-3}^L$. Then $X_{123}^L \neq \emptyset$ as $X_3^L \neq \emptyset$ by Claim A and now we get the contradiction $X_{123}^L \rightarrow X_{13-2}^R \rightarrow X_{1-23}^L \rightarrow X_{3-12}^R \rightarrow X_{123}^L$.

The final case is $X_{12-3}^R \neq \emptyset \neq X_{13-2}^L$ and $X_{13-2}^R = \emptyset = X_{12-3}^L$. We first observe that $X_{123}^R = \emptyset$ as $X_{123}^R \rightarrow X_{1-23}^L \rightarrow X_{3-12}^R \rightarrow X_{13-2}^L \rightarrow X_{123}^R$. As $X_{12-3}^R \rightarrow X_{2-13}^L \rightarrow X_{1-23}^R$ we have $X_{12-3}^R \rightarrow X_{1-23}^R$ and as $X_{1-23}^R \rightarrow X_{1-23}^L \rightarrow X_{3-12}^R$ we have $X_{1-23}^R \rightarrow X_{3-12}^R$. This implies that $d_R^-(X_{1-23}^R) = 0$, a contradiction. This completes Subcase 5.5 and the proof of the theorem. □