



Mobility prediction in 4G D-Cov Networks

Mazen Tlais, Frédéric Weis

► **To cite this version:**

Mazen Tlais, Frédéric Weis. Mobility prediction in 4G D-Cov Networks. [Research Report] RR-5628, INRIA. 2005, pp.23. inria-00070380

HAL Id: inria-00070380

<https://hal.inria.fr/inria-00070380>

Submitted on 19 May 2006

HAL is a multi-disciplinary open access archive for the deposit and dissemination of scientific research documents, whether they are published or not. The documents may come from teaching and research institutions in France or abroad, or from public or private research centers.

L'archive ouverte pluridisciplinaire **HAL**, est destinée au dépôt et à la diffusion de documents scientifiques de niveau recherche, publiés ou non, émanant des établissements d'enseignement et de recherche français ou étrangers, des laboratoires publics ou privés.

Mobility prediction in 4G D-Cov Networks

Mazen Tlais and Frédéric Weis

N°5628

July 2005

_____ Systèmes communicants _____

 ***rapport
de recherche***

Mobility prediction in 4G D-Cov Networks

Mazen Tlais * and Frédéric Weis †

Systèmes communicants
Projet ACES

Rapport de recherche n° 5628 — July 2005 — 23 pages

Abstract: The Infostations system has been introduced to recover the bottleneck of the cellular networks in terms of cost and bandwidth. In this system, small and separated islands of coverage provide intermittent but very high speed rate. The short time the mobile terminal spends in the coverage area has direct impacts on the network performance. The mobile terminal is involved to hide the discontinuous coverage by buffering data in its local cache. The mobile terminal is concerned to maximize the utilization of the bandwidth during the coverage time. To do so, it is essential to avoid the bandwidth wasting due to the overall delay, mainly, the delay occurred when the mobile terminal enters new point of attachment. The network must be able to identify the next point of attachment before the mobile terminal reaches it. This work analyses two well known solutions proposed to handle the mobility prediction in wireless networks. One sees the limitation of these protocols to enable the mobility prediction in the Infostations system. A new mobility prediction protocol is proposed to handle a neighbor graph table that dynamically configures itself according to the terminals' mobility. This protocol is named NDP, Neighbor Discovery Protocol. NDP takes into account the different constraints of the Infostations system particularly the discontinuous coverage. The simulation shows that the the terminals service continuity is significantly improved thanks to NDP.

Key-words: Infostations, caching, discontinuous coverage, mobility prediction

(Résumé : tsvp)

* mazen.tlais@irisa.fr

† frederic.weis@irisa.fr

Prédiction de la mobilité dans les réseaux à couverture discontinue

Résumé : Le coût élevé et le manque de bande passante dans les réseaux cellulaires actuels ont poussé les chercheurs à proposer un nouveau type de réseaux d'accès appelé "réseaux d'Infostations", ou bien encore réseau à couverture discontinue. Ce type de réseau est constitué d'un ensemble de petites zones de couverture disjointes, capables de fournir un débit élevé (de plusieurs dizaines de Mb/s). Le terminal mobile "profite" des périodes de couverture et de la large bande passante disponible pour précharger des données, et masquer ainsi la discontinuité du réseau à l'utilisateur. Dans le but d'utiliser efficacement la bande passante, une approche possible consiste à identifier le prochain point d'attachement avant que le terminal ne l'atteigne. Dans ce rapport, nous analysons deux solutions déjà proposées permettant de prédire la mobilité des terminaux dans les réseaux sans fil. Nous mettons en évidence les limitations de ces protocoles dans le cadre spécifique des réseaux d'Infostations. Cette étude nous conduit à proposer un nouveau protocole de prédiction capable de constituer dynamiquement une table de voisins, en fonction de la mobilité des terminaux. Ce protocole s'appelle NDP, Neighbor Discovery Protocol. NDP prend en compte les différentes contraintes posées par les réseaux d'Infostations, tout particulièrement le fait que la couverture offerte aux utilisateurs ne soit pas continue. Les performances de NDP ont été validées par simulations. Les résultats obtenus montrent que NDP permet une amélioration significative de la continuité de service des terminaux.

Mots-clé : Réseaux d'Infostations, couverture discontinue, prédiction de la mobilité, gestion de caches

1 General introduction

The past few years have witnessed the rise of the cellular networks. These communication systems were designed with a philosophy of "any-time any-where" service. Users wish to receive and place calls at any location and without delay, to move while talking without interrupting their conversations. This requires ubiquitous coverage, which in turn requires significant infrastructure. A modern cellular system is installed with hundreds of base stations, at a cost of hundreds of millions of euros, in order that a communication link is always available. Such any-time any-where service provision becomes increasingly expensive and suffers from low bandwidth. Currently, GSM (Global System for Mobile communications) networks offer merely a transfer rate of 9.6 kbps. GPRS (General Packet Radio Service) networks offer a few ten of kbps and EDGE (Enhanced Data rates for GSM Evolution) networks provide a transfer rate of some hundred of kbps. Emerging, third generation networks, named UMTS (Universal Mobile Telephone Services) aims at supporting up to 2 Mbps services on mobile links.

In our days, several data intensive services are likely to be popular applications, e.g. stored media. Covering wide areas with high radio bandwidth requires complex equalization, due to signal attenuation, multi-path fade, and shadowing effects. Sophisticated radio engineering will lead to improved bandwidth, coverage, and mobile access, but this will be expensive, in terms of both capabilities and cost. However, higher performance can be achieved by combining intelligent network with efficient application and radio design. This suggests an alternate design for wireless networks where intermittent but very high speed is provided to the network through Infostations (ISs) [4]. These high data rates over short ranges have been made possible recently thanks to the advances made in wireless LAN based technologies. In particular advanced radio technologies using multiple antennas at transmitter and receiver sides enable very high data rates. As opposed to any-time, any-where service, we refer to this as "many-time many-where" service. In this architecture, ISs - small and separated islands of coverage - provide discontinuous coverage, high speed, low-cost, low-power access to information services in a mobile environment [3]. Owing the IS scenario with its inherently lower associated coverage costs might be an attractive alternative to the classical concept of any-time any-where communication networks. ISs could be placed in urban environments, along highways, airport lounges, building entrances and many other accessible locations. The mobile terminals (MTs) could be laptop computers or other mobile devices [5].

ISs design would promote the growth of new applications that may be explored in the future. ISs may satisfy the needs of a large class of non-latency sensitive applications, including streaming, interactive map querying, e-mail retrieval, and web browsing. This design is called network aware applications and it requires the adaptation of the applications to be compatible with the IS system [16]. The main challenge of the network aware application design is to enable MT to continue consuming data without disruption even in non covered areas. For delay tolerant data, it suffices to provide high speed access in only a few locations, MT buffers the data as it passes under an IS. Hence, MT may consume stored data even when it passes through regions of poor network coverage. This way we leverage the mobility

of the user and the delay tolerance of the data to transfer data only when it is efficient to do so. Note that since the coverage area of the ISs is small, larger file may need to be delivered across several ISs.

Several projects have been launched to address this type of networks. In these efforts the authors have studied particular cases where the ISs deployment is uniform and the users' movement is already known [3], [5] and [16]. One example of this type of system is studied by WINLAB (Wireless Information Network Laboratory) [5]. In this project ISs are equally spaced and the MT velocity is constant. The file delivery algorithm is tested in a network with one dimensional IS system i.e. high ways. The MT path is known *a priori*. The requested file is divided into several segments that should be sent at a likely known time to different ISs along the path (see Figure 1).

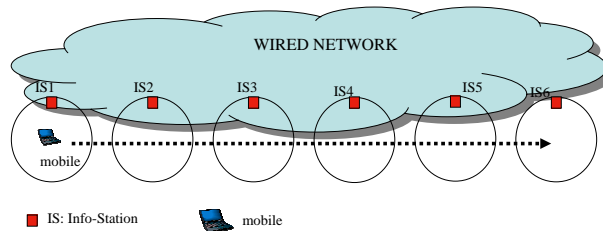

Figure 1: WINLAB architecture

Our approach is based on a more realistic case in which ISs are distributed according to the envisaged traffic and the users are randomly moving in the cells. The main goal is to investigate the effectiveness of ISs system combined with application aware network design. We are involved to enable the network to support this type of applications without service disruption. This requires allowing MT passes under an IS to download data sufficiently to hide the discontinuous coverage to the next IS, and to hide the hand-off and the delivery latencies. This delay produces the loss of some expensive radio bandwidth.

The hand-off latency is occurred when MT enters under the next IS. MT must first scan for available ISs and it must register itself on the suitable IS. This process is called a layer 2 handover. Moreover, MT must verify if its IP address is adequate with the current subnet. In the case where the current subnet does not accept the current MT IP address, MT must request a temporary address from the network according to mobile IP protocol [6]. Mobile IP enables an MT to leave its home network and continue to receive packets sent to its home address (HoA, the address at its home network). A new entity called the Home Agent (HA) is introduced in the MT home network for this purpose. The HA is in charge of intercepting packets addressed to MT while it is away from home, and forwarding them to the MT current location. Mobile IP specifies that an MT must obtain a topologically correct address in the visited network, called a care-of address (CoA), and establish an address binding between this CoA and the HoA. This binding is to be sent to the HA to trigger interception of traffic addressed to MT, and forwarding toward the CoA (see Figure 2). The registration process is called a layer 3 handover. After performing layer 3 handover, MT is able to request data

from the network. MT must wait for data to pass through the fixed network before reach it. This delivery latency will be repeated each time MT hands over between two ISs and sends a request to the server. Since the coverage area is small, the short time MT spends in the coverage area may not be sufficient to perform layer 2 and layer 3 handover and to bring the information from the server to the IS.

To hide the layer 3 handover the MT's context must be transferred from the previous access network to the next access network in a pro-active manner. The MT's context contains the necessary information required to realize a hand-off operation. To reduce the delivery delay, some part of the data that is to be delivered should already have arrived at the next point of attachment before the user passes under it.

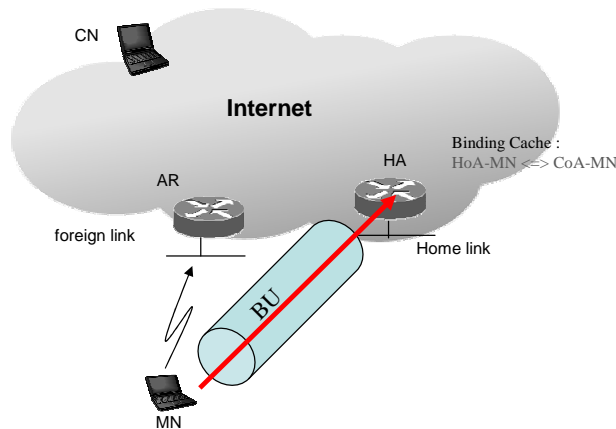

Figure 2: Mobile IP process

Performing pro-active context transfer and pro-active data transfer between two points of attachment should be treated in the ISs system. It requires some mobility prediction of the next potential point of attachment to be done in the network. We will start by studying two solutions proposed by the Internet Engineering Task Force (IETF) and the Institute of Electrical and Electronics Engineers (IEEE). The goal of these solutions is to enable the mobility prediction in the network. We will show their limitations to be implemented in the ISs system. Then, a new solution of mobility prediction is described and validated. It takes into account the different constraints mainly the discontinuous coverage. The required architecture that should enable us to achieve our goals is described in chapter 2. Chapter 3 describes our solution to handle the mobility prediction in a discontinuous coverage. Then chapter 4 presents the implementation of the pro-active transfer algorithm within the simulator.

2 System architecture

This chapter describes the required architecture. Many problems are treated mainly the scalability of a large scale deployment of ISs. The next section presents an IETF proposition of a large scale ISs deployment. Section 2.2 discusses the need for a proxy cache to avoid service disruptions. Finally, section 2.3 concludes the chapter.

2.1 Introduction

ISs have been introduced by WINLAB with data rate that may reach 50 Mbps or even more. They can be placed at hot spots according to the envisaged traffic or at regularly spaced intervals e.g. along high ways, etc. A large scale deployment of ISs is highlighting certain technical challenges. As outlined in [13], management and control of large number of APs (ISs in our case) in the network may need significant network signaling load. Distributing and maintaining a consistent configuration throughout the entire set of ISs in the wireless local area network (WLAN) is a difficult task. This requires effective coordination among the ISs to maximize network performance.

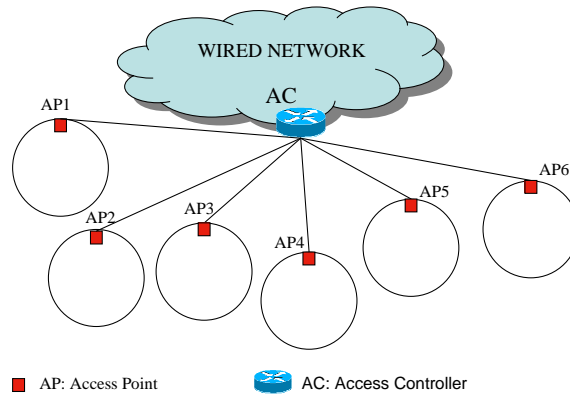

Figure 3: IETF centralized architecture

Figure 3 shows the centralized hierarchical architecture [15] described by the IETF organization. An access point AP is a layer 2 device which is connected to the access controller and offers the wireless link connection to MTs [11]. WLAN centralized architecture uses access controllers (ACs) to improve management scalability, and to facilitate dynamic configuration of the APs that are present in the network. The AC in this architecture may be co-located with a layer 3 router, and hence may be referred to as Access Router (AR). The AC may also become a natural aggregation point for the data plane of several APs. This architecture has several distinct characteristics. First, the centralized architecture gives much better manageability for the large scale networks and facilitates dynamic configurability. Second, the APs themselves may not implement the full 802.11 functions as defined

in the standards any more since the IEEE 802.11 functions may be provided by the APs and the AC together. Closer examination of the AC functions reveals that different resource requirements (e.g. CPU, memory, storage) may require to being distributed across different devices [15]. For instance, complex control algorithms can be CPU intensive. Storing and downloading images and configurations can be storage intensive. Therefore it is possible that multiple ACs are present in a network for purposes of load balancing as shown in Figure 4.

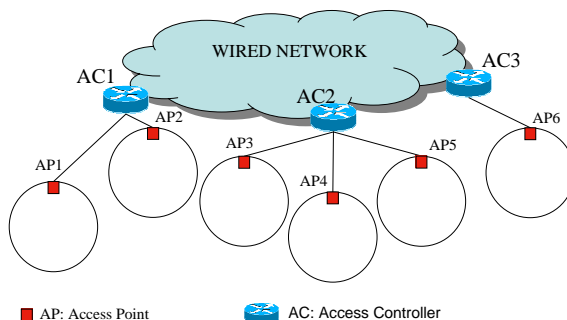

Figure 4: IETF hierarchical architecture

2.2 Required architecture

Figure 5 shows schematically our required network architecture where each AC is connected to multiple ISs via wired network. Streaming flows consume a significant amount of network bandwidth even in compressed form. For example in the context of web access the mean value of a video object is about 121 Mbytes [2]. Since the time for which MT is under coverage is short (few seconds) the objective of our architecture is to send data to MT as effectively as possible to hide the discontinuous coverage and the overall latency. One solution is to avoid the service disruption by implementing proxy caches into the network. The incoming data from the database server can be stored in the proxy caches even when MT is in the non covered areas. Then, as MT arrives under IS, it starts downloading data with a high rate to continue running the service up to the next IS without disruption. This is possible thanks to the high radio rate (several Mbps) which is likely higher than the service rate (several hundred of kbps). Hence, it is possible to download a significant amount of information even when MT is in the coverage area for a short time.

The first matter is to choose where these caches must be implemented. We prefer to install the data caches within the ACs instead of the ISs. In fact, implementing the proxy caches in the ISs is a very expensive solution since it affects the main infrastructure in the overall network. More explanation is given in the next chapter. The second matter is to perform a pro-active context transfer to reduce the hand-off latency and a pro-active data transfer to reduce the delivery latency. When MT changes the current AC, the MT's context and the MT data must be transferred to the next AC before the arriving of MT under it.

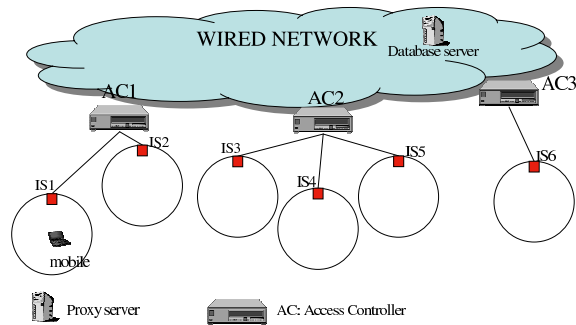

Figure 5: Required architecture

This requires some mobility prediction of the next potential AC to be done in the network. While it is difficult to predict the next point of attachment exactly, it is possible to find a reasonable set of candidate points of attachment that are likely to be the next point of attachment after a hand-off operation [14] [10]. In most cases the whole ways under a point of attachment take people to some neighbor points of attachment and not to all of them.

In addition to the classical function, AC should play the role of application proxy to manage its cache. As shown in Figure 6, AC is comprised of a proxy entity and a cache entity. The proxy entity is responsible for managing the cache entity which is constituted of many lines of cache (LoC). All data transfer occurs as a result of requests made by MT. The request reaches the AC, which in turn makes this request to the database on behalf of MT. We assume that the whole network except the MT user is fixed. When MT hands over from the current IS (or AC) to the next IS (or AC) then both ISs (or ACs) are called neighbor ISs (or ACs) to each other. The source node is a MT's previous IS (or a MT's previous AC) and the target node is a MT's next IS (or a MT's next AC). The terms candidate IS and candidate AC define respectively an IS and AC to which MT may do a hand-off. The term owner AC is used to indicate an AC that is connected to several ISs.

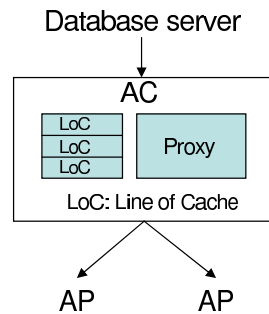

Figure 6: AC architecture

2.3 Conclusion

In this chapter, a hierarchical architecture has been described. It has been highlighted the need for a proxy cache implementation and a pro-active transfer algorithm to avoid the service disruption. In the next chapter the mobility prediction problem is addressed.

3 Mobility prediction

The next section discusses the limitation of the classical mobility prediction protocols proposed by IETF and IEEE. In section 3.2 we describe our solution based on "a mobility graph". Finally, section 3.3 concludes the chapter.

3.1 Related work

To hide the delay that produces the loss of some expensive bandwidth many solutions are possible. An intuitive solution is to flood data to all ISs and/or ACs, but this solution is not efficient since it may easily overload the network. Another solution is to use a neighbor graph. The neighbor graph is an approximation of the mobility graph. It can be configured statically, i.e, generated once and never changes during operation. However, constructing a static neighbor graph to approximate the mobility graph is challenging since a static neighbor graph fails to approximate the mobility graph which changes dynamically over time. Thus, a dynamic method of building a self-adaptive neighbor graph that dynamically changes according to the mobility graph is preferred. The autonomous generation is a scalable solution and it eliminates the need for any survey or other manual based construction methods. Using neighbor graph, if we allow data forwarding to candidate points of attachment just before, or during, the hand-off process then we can hide the hand-off latency, without introducing significant complexity to the network or to MT [14].

Several protocols have been proposed to dynamically discover neighbor graph. Researchers in IEEE 802.11F have focused on an inter access points protocol to let AP learns about its neighbor APs. While researchers in IETF have concentrated on a candidate access router discovery protocol to let AR learns about neighbor ARs and APs.

Inter Access Point Protocol (IAPP) In [1], the authors propose a protocol in which each AP learns and registers a neighbor graph that contains all possible candidate APs. An example of this protocol is illustrated in Figure 7. In this Figure we distinguish three access points: AP1, AP2 and AP3. MT is initially under AP1 (current AP) and it moves toward AP2 (next AP). When MT leaves AP1 and enters under AP2, it sends a re-association request to AP2. This message contains the identifier of AP1 (AP1-ID). Upon receipt of this message, AP2 starts the relationship with AP1 and each of them, AP1 and AP2, adds the other as a neighbor AP. After executing this protocol for some time, AP1 registers AP2 as a neighbor, AP2 registers AP1 and AP3 as neighbors and AP3 registers AP2 as a neighbor. Henceforth, when AP1 detects that MT has left its coverage, it sends the MT's context to AP2 in a pro-active manner before that MT reaches AP2. As well, when AP2 detects that an MT has left its coverage, it sends the MT's context to AP1 and AP3. Notice that the pro-active scenario is proposed in [12] as an extension of IAPP.

Pro-active transfer requires the implementation of a data cache in each AP. This is to allow AC to send data to the next AP before that MT reaches it. Hence, to support IAPP, caches protocols must be implemented in the APs which affect the main infrastructure in the overall network.

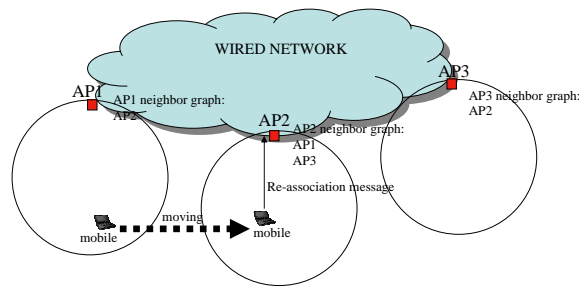

Figure 7: IAPP protocol

Candidate Access Router Discovery Protocol [9] describes a Candidate Access Router Discovery protocol (CARD protocol). When MT listens to new APs, a mechanism is needed for reverse address translation. The function of the CARD protocol enables the AR to map the received ID of the next AP to the IP address of the owner AR. We show in Figure 8 an example of this protocol. AP1 is connected to AR1, AP2 and AP3 are connected to AR2, and AP4 is connected to AR3. MT is initially under AP1 and it moves toward AP2. When it reaches the border of AP1, MT sends a message to its current access router AR1 to notify it about the presence of AP2 as a next AP. Upon receipt of this message, AR1 searches¹ for the owner AR of AP2, and adds the association between AP2 and AR2 {AP2, AR2} to its neighbor graph. Performing CARD protocol for some time allows AR1 to add the association between AP2 and AR2 {AP2, AR2} to its neighbor graph. As well, AR2 adds {AP1, AR1} and {AP4, AR3} to its neighbor graph and AR3 adds {AP3, AR2} to its neighbor graph. Henceforth, when MT sends to AR1 a message that contains AP2-ID as a next AP, AR1 checks its table to identify the owner AR which is AR2. Then the pro-active transfer starts between AR1 and AR2.

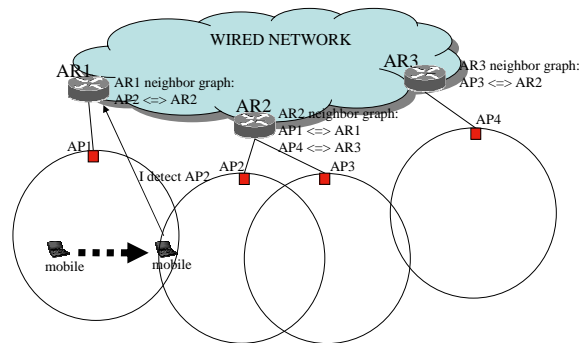

Figure 8: CARD protocol in a continuous coverage

¹The way of how AR1 searches for the owner AR of AP2 is out the scope of this work

CARD protocol is based on that MT detects simultaneously the current and the next APs to construct the neighbor graph. Compared to our network architecture, as shown in Figure 9, AP1 does not overlap with AP2. Since our coverage is discontinuous MT will not detect any potential candidate AP other than the current one. Hence, no pro-active transfer can be done in the network without involving some modifications to enable the CARD protocol to support such architecture.

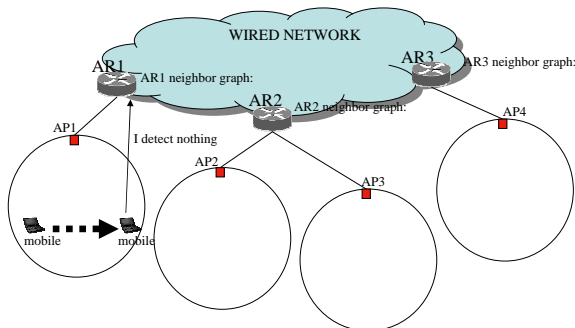

Figure 9: CARD protocol in a discontinuous coverage

Other protocols Other approaches exist. For example, the WiMax (IEEE 802.16e) solution is a mix of the presented solutions. In WiMax, when MT detects that is near to hand-off, it listens to neighbor APs and provides the list of potential target APs to the current AP. The current AP (with a backbone signaling process) can shrink the list of potential target APs to a subset. It then returns such subset to the terminal that can effectively hand-off toward one of the APs in the returned subset. This solution is similar to CARD, but at AP layer.

3.2 Novel neighbor discovery protocol

Contrarily to IAPP, performing a modified version of CARD protocol affects the APs with minor modifications but the ACs are significantly affected. Nevertheless, the number of candidate APs is much greater than the candidate ACs' number. Hence, installing the CARD protocol will be less complex and less expensive than installing the IAPP protocol in terms of cost and bandwidth. Our researches are focusing on a novel protocol to identify the next point of attachment. This protocol is called NDP, Neighbor Discovery Protocol. It takes into account different constraints mainly the discontinuous coverage. As opposed to IAPP, when MT moves between two APs under the same AC there is no need to perform a pro-active transfer since no data have been cached within the APs. On the other hand, if MT leaves the current AC then a pro-active transfer is needed and the traffic sent to MT must be forwarded to the current location of MT and to one or more ACs where MT is expected

to move to shortly. When MT hands over between two ACs, the network should be able to identify the next potential ACs through the current AP. The idea is to maintain a table mapping between each AP and the potential candidate ACs instead of the table mapping between the next AP and its owner AC proposed in CARD, or between each AP and the potential candidate APs proposed in IAPP. This table is configured dynamically and it's called candidate access controllers (CAC) table. The CAC² table may be constructed either in a distributed or a centralized manner.

Distributed neighbor discovery protocol To discover the neighbor graph in a distributed manner we define a protocol through which each AC learns about its neighbors. For doing so, each AC configures:

1. A CAC table that maps every owned AP with the potential candidate ACs { owned AP, next AC }. Based on this table, an AC takes decision about performing pro-active transfer with the potential candidate ACs.
2. A NAP table (neighbor access points). The AC stores in this table the APs belonging to other ACs and associating with it as a potential candidate AC. The utility of this table is to allow the AC to ensure if it is still a candidate AC for these APs or not. This table contains a neighbor AP-ID field, a field of the owner AC IP address and a timer field { neighbor AP, neighbor AC, timer }. If AC is not co-located with a layer 3 router, the AC IP address is replaced by the AC identifier.

Figure 10 and Figure 11 show the procedure through which each AC learns about the potential candidate ACs of its own APs. MT sends a registration message (message 1 in Figure 10) to the new AC (AC2). This message is used to notify AC2 of the old AP identifier (AP1-ID) and the IP address of the owner AC (AC1-IP) of AP1. AC2 checks its NAP table, if AP1-ID is already registered as a neighbor then AC2 re-starts the timer of AP1-ID field. Else, if AP1-ID is not registered then AC2 sends to AC1 a message (message 2) that contains AP1-ID. Upon receipt of this message, AC1 refreshes its CAC table and associates the AP1-ID field with AC2 IP address. Then AC1 replies to AC2 by a positive response (message 3). On receiving the reply message, AC2 adds AP1-ID and AC1 IP address to the NAP table and starts the timer. This procedure (messages 1, 2 and 3) will be executed once at the beginning of the network installation. From now on, every time AC2 receives a registration message that contains AP1-ID as an old AP then the corresponding timer is re-started. Once no MT notifies AP1-ID as an old AP, the timer expires and AC2 notifies AC1 that it is not anymore a candidate AC for AP1-ID. Finally, AC1 removes the association between AP1-ID and AC2 IP address from its CAC table and AC2 removes the AP1-ID field from its NAP table. Hence, as time passes, each AC learns more and more about the network topology and dynamically configures itself to construct the CAC and NAP tables.

²CAC table may be useful for other goals. For instance, when the user is in the areas of poor coverage, it may use the cellular network to send the data request. In this case, using the CAC table the network may identify the next potential ACs to send data before the user arriving.

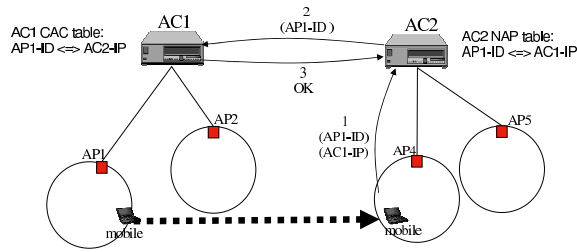

Figure 10: Distributed neighbor discovery protocol

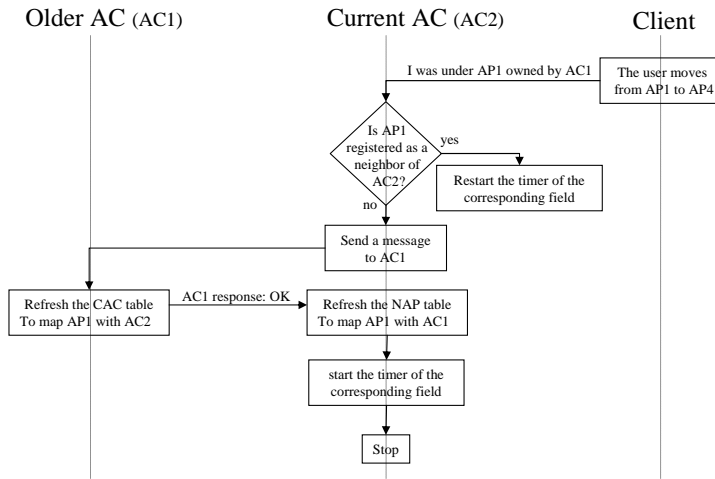

Figure 11: Distributed neighbor discovery algorithm

Notice that if the mobility is similar in both directions then it could be useful that AC2 adds the mapping between AP4 and AC1 to its CAC table. In this case, AC1 also must add the mapping between AP4 and AC2 to its NAP table. Moreover, in the NAP it could be useful to add the new AP-ID to the registration message. For example, for AC2 the NAP could be {AP1, AC1, timer, AP4}. In case of AP4 failure AC2 is then able to pro-actively send a message to AC1 to de-register itself from being in the neighbor tree of AP1. Without such information, AC2 has to wait for the time-out of AP1 entry in its NAP. The goal is to reduce the multi-cast traffic flooding.

Centralized neighbor discovery protocol The centralized approach defines a protocol through which a mobility proxy maintains a CAC table that maps each AP in the network with the potential candidate ACs. NAP table is merged into CAC table; the timer field and

the neighbor AC IP address are added to the CAC table. The new form of the CAC table is {old AP, old AC, current AC, timer}.

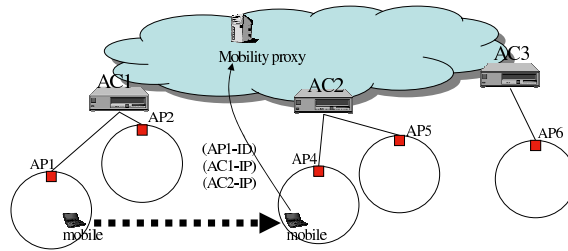

Figure 12: Centralized neighbor discovery protocol

Figure 12 and Figure 13 illustrate a typical scenario of the centralized protocol. MT notifies the proxy about the old AP-ID (AP1-ID) and the owner AC (AC1) through a message that contains also the IP address of the novel AC (AC2). The proxy checks its CAC table, if AC2 IP address is already registered as a candidate of AP1 then it re-starts the timer of AP1-ID. Else, if AC2 is not registered as a candidate of AP1 then the proxy refreshes its CAC table, associates AP1-ID and AC1 IP address with AC2 IP address and starts the timer. Once no MT notifies AP1-ID as old AP, the timer expires and the proxy removes the corresponding field from the CAC table.

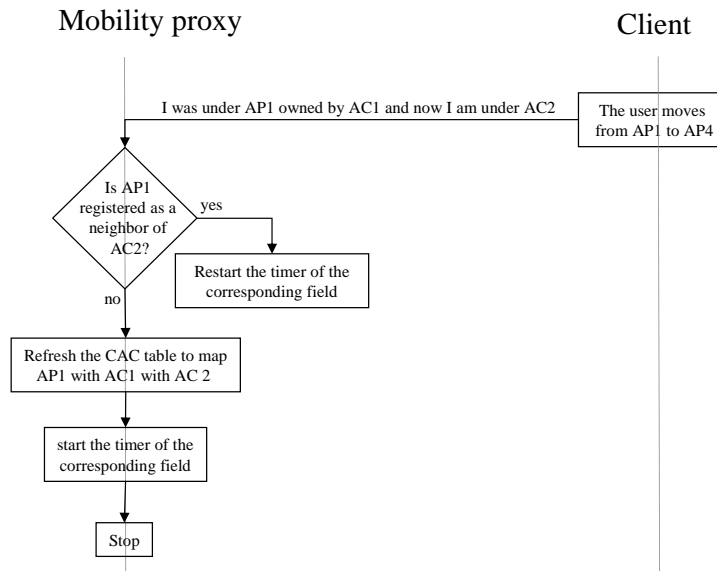

Figure 13: Centralized neighbor discovery algorithm

3.3 Conclusion

In this chapter two well known neighbor discovery protocols IAPP and CARD have been presented. Analysis of these protocols has highlighted some limitations due to the discontinuous coverage and hierarchical architecture. A suitable discovery protocol that takes into account different constraints has been proposed. The next chapter proposes a pro-active transfer algorithm and shows the simulation results.

4 Pro-active transfer implementation

In this chapter, we analyse the pro-active transfer algorithm and discuss the implementation of the distributed neighbor discovery protocol (DNNDP) within the described architecture. The next section presents a solution to enable a pro-active transfer algorithm bypassing the limitation due to mobile IP issues. Section 4.2 shows the simulation results to demonstrate the performance of the proactive caching.

4.1 Pro-active transfer algorithm

Pro-active transfer is an important mechanism for maximizing the utilization of the radio bandwidth. Implementing proxy caches is necessary not only to avoid the service disruption but it is useful for the overall network performance. Proxy caches are helpful for reducing hand-off and delivery latencies. [8] proposes a fast handover procedure to address the hand-off latency problem. This procedure requires MT to obtain a new CoA at the next AR while connected to the previous AR. Recall that CoA is a temporary address obtained in the visited network to correctly forward data to the new MT location. MT or the previous AR may initiate this procedure by using information that MT will soon leave the current AR. Upon detecting a handover situation, the previous AR must establish a bidirectional tunnel between itself and the next AR. Then, the previous AR uses this tunnel to forward the MT's packet to the next AR. [7] extends the fast handover protocol. In this later proposition, the previous AR sends a copy of the data simultaneously to the old CoA and to the new CoAs. The previous AR stops sending data when a special lifetime expires. Using both [8] and [7] the network is able to send data to several destinations during the hand-off operation.

Based on our neighbor discovery protocol, a CAC table is maintained by each AC (in the distributed scheme) or by the mobility proxy (in the centralized scheme). This table maps between each AP and the potential candidate ACs. The pro-active transfer is illustrated in Figure 14. When AC (in the distributed scheme) detects that one of the MTs has left its region it checks its CAC table to identify the candidate AC. Then it sends a message to the candidate AC to notify it about the MT's context. The context contains mainly the object identifier and the segment number of the MT's application. In the centralized scheme, since the old AC does not know the candidate AC IP address, the mobility proxy must communicate this IP address to the old AC before that the context transfer process may have been started. Upon receiving this context, the candidate AC must construct a new CoA and checks its proxy cache. If the requested segment is a cache miss then the candidate AC sends a message to the previous AC to duplicate the transmission of data to itself. Finally, the previous AC starts duplicating data until a particular lifetime expires.

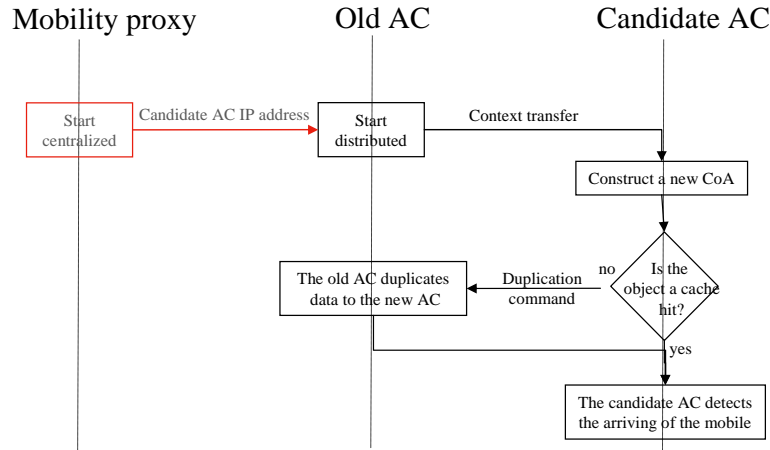

Figure 14: Pro-active transfer

4.2 Simulation results

Our goal is to study the improvement brought to the service performance thanks to the learning process. As well to show the cost of using the learning process. We used the following features for the topology configuration:

1. The wireless test-bed spans an area of 840×1080 meters and the simulated time is one hour.
2. There are one streaming server, three ACs, 40 APs and 362 MTs.
3. The server streaming rate is 256 Kb/s and the stream packet size is 1500 bytes.
4. The AP topology is Manhattan, the AP coverage area is 50 m, and the AP radio rate is 53 Mb/s.
5. The MT movement is random in a Manhattan topology and the MT speed is 9 m/s.

The first simulation is launched without ACs neighbor relationships. We supposed that when MT enters a new AC it stops to send and receive data until it receives a correct IP address and registers it with HA. This disruption time may reach 4 or even 5 second, in our simulation, it is limited to be between 1.5 and 2.5 second. The simulation results have highlighted that the MTs' caches have had a total crossing number by zero of 273. Which means services have been disrupted 273 times. The second simulation is conducted using neighbor graph learning. We assumed that when MT is going to leave the current AC, the network gives MT a correct IP address in a pro-active manner. The learning process floods packets to all potential next AC in addition to the current one. Using the learning process,

we have not obtained any crossing by zero in the MTs' caches. Which means services have not been disrupted.

Figure 15 and Figure 16 show the cost of the MT service improvement. Figure 15 shows the AC cache size without learning process. The time evolution is represented by the x axis (in second). The y axis represents the AC cache size (in KB). The average size of the AC cache is about 34.5 MB. Figure 16 shows the AC cache size using the learning process. The average size of the AC cache is about 56.5 MB. We conclude that performing DNDP has significantly improved the service continuity while in the same time it has increased the AC cache size by 64%.

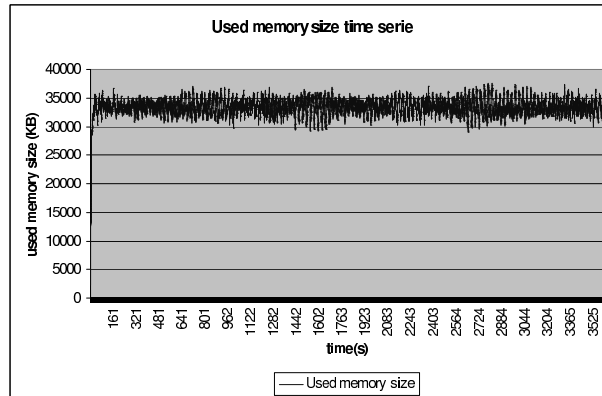

Figure 15: AC cache size without learning process

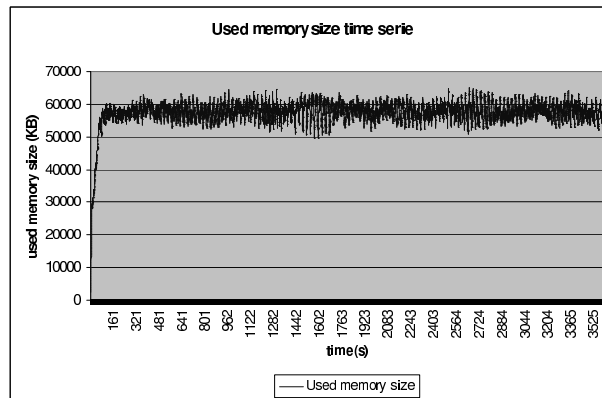

Figure 16: AC cache size using learning process

5 Conclusion

This work has described a new access network architecture called hierarchical ISs system. It has investigated the serious delay effects on the network performance in such an architecture. The need for mobility prediction has been highlighted to avoid the bandwidth wasting. Two well known mobility prediction protocols IAPP and CARD have been presented. Analysis of these protocols have pointed out some limitations due to the hierarchical ISs system. A suitable new protocol called NDP has been proposed. NDP is based on a dynamic method of building a neighbor graph that configures itself according to the terminals' mobility. The validation by simulation has shown the improvements brought to the terminals' service continuity thanks to NDP. Our future work will concentrate on the new services made possible thanks to the architecture characteristics.

References

- [1] Ieee trial-use recommended practice for multi-vendor access point interoperability via an inter-access point protocol across distribution systems supporting ieee 802.11(tm) operation. Technical report, IEEE Standard 802.11F, 2003.
- [2] S. Acharya, B. Smith, and P. Parns. Characterizing user access to video on the world wide web. In *Proceedings of MMCN*, January 2000.
- [3] R. H. Frenkiel, B. R. Badrinath, J. Borras, and R. Yates. The infostations challenge: Balancing cost and ubiquity in delivering wireless data. *IEEE Personal Communications*, April 2000.
- [4] R. H. Frenkiel and T. Imielinski. Infostations: The joy of many-time, many-where communications. Technical report, Technical Report TR-119, WINLAB, Rutgers University, April 1996.
- [5] A. L. Iacono. Bounds on file delivery delay in an infostations system. In *IEEE Vehicular Technology Conference Proceedings vol. 3*, Spring 2000.
- [6] D. Johnson, C. Perkins, and J. Arkko. Mobility support in ipv6. Technical report, IETF standard 3775, June 2004.
- [7] H. Soliman K. El Malki. Simultaneous bindings for mobile ipv6 fast handovers. Technical report, Internet Draft, IETF, work in progress, October 2003.
- [8] R. Koodli. Fast handovers for mobile ipv6. Technical report, Internet Draft, IETF, work in progress, October 2003.
- [9] M. Liebsch, A. Singh, E. Shim, and al. Candidate access router discovery. Technical report, Internet Draft, IETF, work in progress, September 2004.
- [10] J. Loughney, M. Nakhjiri, C. Perkins, and R. Koodli. Context transfer protocol. Technical report, Internet Draft, IETF, work in progress, August 2004.
- [11] J. Manner and M. Kojo. Mobility related terminology. Technical report, Network Working Group, IETF, June 2004.
- [12] A. Mishra, M. Shin, and W. Arbaugh. Context caching using neighbor graphs for fast handoffs in a wireless network. In *INFOCOM IEEE*, 2004.
- [13] B. O'Hara, P. Calhoun, and J. Kempf. Capwap problem statement. Technical report, Internet Draft, IETF, work in progress, August 2004.
- [14] E. Shim and R. D. Gitlin. Fast handoff using neighbor information. Technical report, Internet Draft, IETF, work in progress, November 2000.

- [15] L. Yang, P. Zerfos, and E. Sadot. Architecture taxonomy for control and provisioning of wireless access points (capwap). Technical report, Internet Draft, IETF, work in progress, November 2004.
- [16] T. Ye, H.-A. Jacobsen, and R. Katz. Mobile awareness in a wide area wireless network of info-stations. In *Proc. of Mobicom*, October 1998.

Contents

1	General introduction	3
2	System architecture	6
2.1	Introduction	6
2.2	Required architecture	7
2.3	Conclusion	9
3	Mobility prediction	10
3.1	Related work	10
3.2	Novel neighbor discovery protocol	12
3.3	Conclusion	16
4	Pro-active transfer implementation	17
4.1	Pro-active transfer algorithm	17
4.2	Simulation results	18
5	Conclusion	20



Unité de recherche INRIA Lorraine, Technopôle de Nancy-Brabois, Campus scientifique,
615 rue du Jardin Botanique, BP 101, 54600 VILLERS LÈS NANCY
Unité de recherche INRIA Rennes, Irista, Campus universitaire de Beaulieu, 35042 RENNES Cedex
Unité de recherche INRIA Rhône-Alpes, 655, avenue de l'Europe, 38330 MONTBONNOT ST MARTIN
Unité de recherche INRIA Rocquencourt, Domaine de Voluceau, Rocquencourt, BP 105, 78153 LE CHESNAY Cedex
Unité de recherche INRIA Sophia-Antipolis, 2004 route des Lucioles, BP 93, 06902 SOPHIA-ANTIPOLIS Cedex

Éditeur
INRIA, Domaine de Voluceau, Rocquencourt, BP 105, 78153 LE CHESNAY Cedex (France)
<http://www.inria.fr>
ISSN 0249-6399