

Framing Protocols on Upstream Channel in CATV Networks: Asymptotic Average Delay Analysis

Philippe Jacquet, Paul Mühlethaler, Philippe Robert

► **To cite this version:**

Philippe Jacquet, Paul Mühlethaler, Philippe Robert. Framing Protocols on Upstream Channel in CATV Networks: Asymptotic Average Delay Analysis. [Research Report] RR-4114, INRIA. 2001. inria-00072517

HAL Id: inria-00072517

<https://hal.inria.fr/inria-00072517>

Submitted on 24 May 2006

HAL is a multi-disciplinary open access archive for the deposit and dissemination of scientific research documents, whether they are published or not. The documents may come from teaching and research institutions in France or abroad, or from public or private research centers.

L'archive ouverte pluridisciplinaire **HAL**, est destinée au dépôt et à la diffusion de documents scientifiques de niveau recherche, publiés ou non, émanant des établissements d'enseignement et de recherche français ou étrangers, des laboratoires publics ou privés.

***Framing protocols on upstream channel in
CATV networks: asymptotic average delay
analysis***

Philippe Jacquet , Paul Mühlethaler , Philippe Robert

No 4114

Février 2001

———— THÈME 1 ————



***rapport
de recherche***

Framing protocols on upstream channel in CATV networks: asymptotic average delay analysis

Philippe Jacquet , Paul Mühlethaler , Philippe Robert

Thème 1 — Réseaux et systèmes
Projet HIPERCOM

Rapport de recherche n° 4114 — Février 2001 — 22 pages

Abstract: This paper deals with bandwidth management of the upstream channel of a CATV network. The upstream channel bandwidth must be split between random access and reserved access. This splitting is obtained via a framing protocol. This framing may be “explicit” i.e. defined by special control signals or “implicit” i.e. defined by the reservation scheme. We describe in details four framing management schemes of the upstream channel. We then study these framing management schemes with simple analytical models. An asymptotic average access delay analysis (when the propagation is large) is provided. As a result of our models, we show that implicit framing outperforms explicit framing schemes.

Key-words: Cable TV network (CATV network), upstream channel, reservation scheme, framing, bandwidth management, performance evaluation, access delay.

(Résumé : tsvp)

Gestion de la bande passante sur le canal montant d'un réseau câblé de télévision: analyse asymptotique du délais moyen

Résumé : Ce papier traite de la gestion de la bande passante sur le canal montant d'un réseau câblé de télévision. La bande passante du canal montant doit être partagée entre une partie dédiée à l'accès aléatoire et une partie dédiée à la l'accès avec réservation. Ce partage est obtenu par un protocole de "framing" sur le canal montant. Ce "framing" peut être explicite ou implicite. Dans les techniques de "framing" explicite le partage de bande passante est défini par des signaux physiques de contrôle alors que dans les techniques de "framing" implicite ce partage est défini par le protocole de réservation. Nous décrivons en détail quatre schémas de gestion la bande passante sur le canal montant. Nous étudions ensuite ces schémas avec des modèles analytiques simples. Une analyse asymptotique du délais moyen d'accès (lorsque le délais de propagation est grand) est proposée. Ces modèles montrent que le "framing" implicite donne de meilleures performances que le "framing" explicite.

Mots-clé : Réseau câblé de télévision (CATV network), canal montant, "framing", accès par réservation, évaluation de performance, délais d'accès.

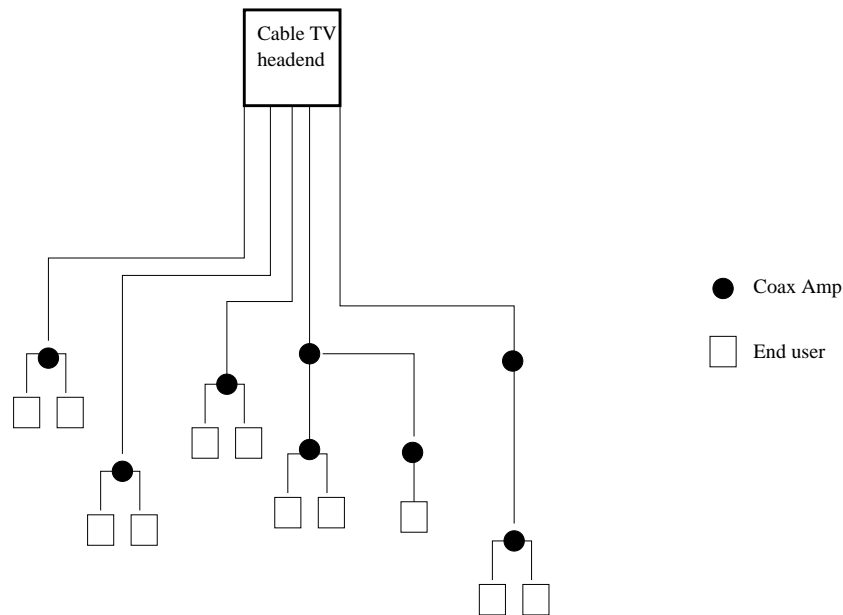

Figure 1: General architecture for CATV.

1 Introduction

A CATV network physically looks like a tree made of coaxial cables and usually covers an area of several blocks of houses. Some hybrid networks are made of both coaxial and fiber cables. The end-users are connected to the external nodes of the tree. The internal nodes are amplifiers which cope to signal decay due to branching and/or distance. The bandwidth of the cable is divided into two classes of one way channels: upstream channels and downstream channels. The distribution system relies on the head-end which is located at the root of the tree. See figure 1.

The communication medium of a CATV network consists in one pair of channels:

- A downstream channel which broadcast all signals from head-end to end users;

- An upstream channel which collects all signals from end users to head-end.

The head-end monitors the multiple access to the upstream channel. To this end, it feedbacks the end-users via the downstream channel (or a small portion of it). All end-users are synchronized on a common time reference and locked on the same round trip propagation delay R (the sum of the inbound and outbound propagation delays), via, for example, time buffers. To achieve this synchronisation each end user must know its round trip propagation delay to the head-end. This is done via a procedure called ranging procedure which is not in the scope of the paper. Reference [1] explains how this ranging procedure operates and provides a further background for CATV networks.

In the following we assume that all ranging procedures are done and that all end-users simulates the same propagation delay. We will assume that R is large compared to packet transmission time.

The paper focuses on transmission of asynchronous data. Such traffic is expected to be the main part of CATV traffic, since CATV networks aim to carry Internet traffic. Due to the large propagation delay a CSMA-CD approach as in Ethernet is not possible, since collisions which cannot be detected and aborted in real time will significantly reduce the bandwidth efficiency to a small fraction of channel capacity (unslotted ALOHA: 18%). Therefore an approach like Reservation ALOHA seems more convenient. Reference [2] presents access protocols for CATV network including a reservation scheme. For each transmission:

- the end-user send a request to the head-end indicating the length of data to be sent;
- if the request is successful, the head-end sends back a grant packet which indicates the time interval reserved for the data transmission of this particular end-user;
- The end user transmits its packet in the corresponding time interval.

Clearly the minimum access delay for an asynchronous packet cannot be smaller than $2R$. The end-users must transmit its requests packets in special

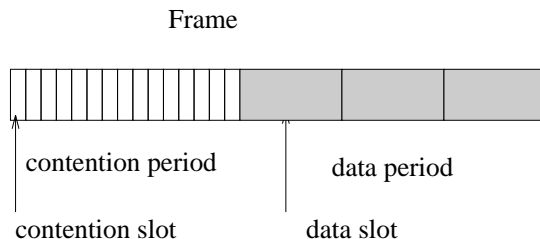

Figure 2: One frame on the upstream channel.

period called contention periods. The contention periods are divided in contention slots and a request packet exactly fits one contention slot. The data are transmitted during reserved periods called data periods. The data periods are divided into data slots, each data slot fits one data packet which can be of variable length. Fixed variable length can be used and fitted to ATM cells. The protocol which is used to manage the alternance between contention periods and data periods is called the framing protocol, and the aim of this paper is to compare different framing protocol in terms of performance. This paper is organized as follows. In the next section, we explain the difference between explicit and implicit framing protocols. In section 3, we describe four different framing protocols. In section 4, we give an analytical model for our proposed framing protocols. Section 5 gives the numerical results of the comparison between the four proposed framing protocols. This paper has been offered to the IEEE 802.14 comity.

2 Explicit or implicit framing protocols

Viewed from end-users side the frame consists into an alternance of one contention period with one data period. See figure 2. Viewed from head-end side, the requests and the data are received one inbound propagation delay after their respective transmissions on the upstream channel. The head-end must transmit on the downstream channel “interframe boundary” packets (IB packets) which are received one outbound propagation delay later by the end user in order to kick off the next frame.

The IB packet contains all the information needed to properly use the incoming frame, *i.e.* the length of the contention periods and the length of the data period together with the respective schedules of the granted data slots. The IB packet is not a formal need. Alternatively, data slots could be granted one by one by separated granting packet transmitted one outbound propagation delay time before each data slots. In this case the contention period end could be implicitly closed by the first received granting packet and the frame could be ended as soon all granted data slots expires. In this case one speaks of *implicit* framing in opposition to *explicit* framing via IB packets. Intermediate implementation between explicit and implicit framing are possible.

With explicit framing it is clear that all request for the next frame must be received before the transmission of the IB packet. Therefore if a request is transmitted less than R time before the reception of the IB packet, then the data slot would be granted on the second after next frame, because it cannot be granted in the current IB packet. One call this effect the *late request* effect, this will lead to some minor side effect in delay computations.

When an end-user has transmitted a request which was not received by the head-end due to some collision or error, it will be informed in the IB packet (possibly by default because it does not receive grant). Therefore collided request could retransmitted on the next frame (or in the second after next if late request with explicit framing).

Figure 3 shows an example of framing operation. We display on the same time scale the upstream channel on the end-user side and on the head-end side, and the downstream channel on the head-end side. Notice that requests and packets are received R time after their transmission. To simplify we assume that all propagation delays are on the upstream channel and none on the downstream channel. In fact, we should probably assume that the round time delay R is half on the upstream channel and half on the downstream channel, this is only a translation of $R/2$ in the access delays with no change in late request occurrence. To simplify the example, we also get rid of collision occurrence.

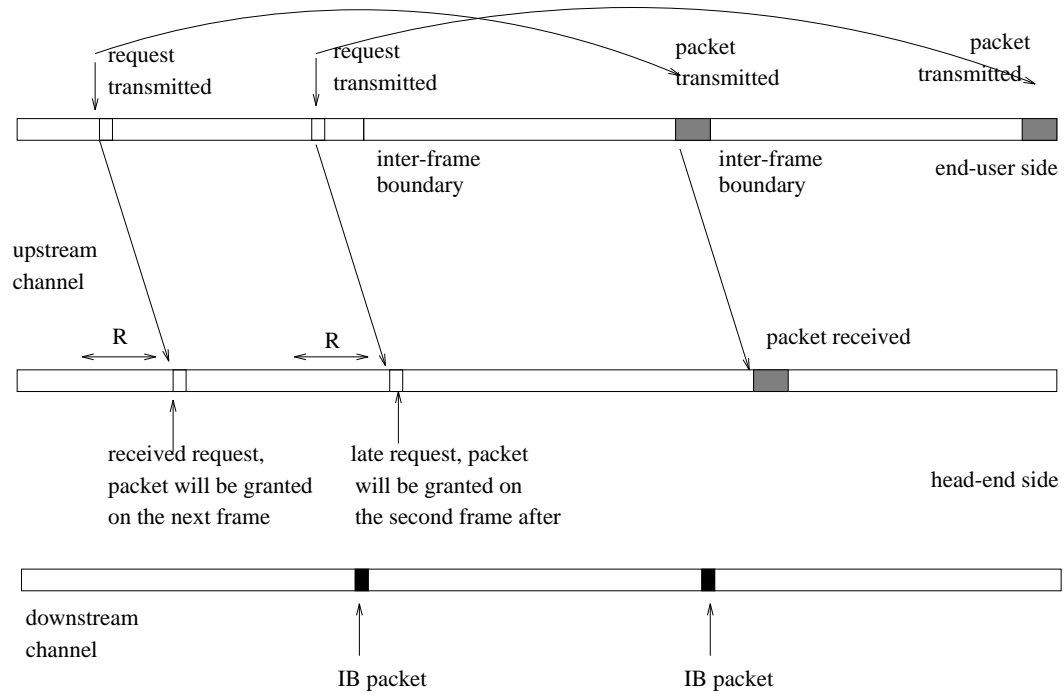

Figure 3: Framing operation, end-user side versus head-end side.

3 Description of framing protocols

We will describe four types of framing protocols:

1. the Fixed Ratio Framing protocol;
2. the Variable Ratio Framing protocol;
3. the Variable Length Framing protocol;
4. the Minimal Implicit Framing protocol.

The three first protocol belong to the class of explicit framing, the last protocol is clearly belongs to the class of implicit framing.

3.1 Fixed Ratio Framing protocols

In this protocol, hereafter nicknamed “FRF”, the frames are always of the same length and the contention periods are always the same: *i.e.* the ratio between contention and data is always the same length. In this case it will be very likely that only a fraction of the data slots will be granted, the other data slots will remain vacant. The busy data slots are grouped at the end of the data period and are granted according to a FIFO policy (First In First Out) regarding requests reception times.

When the network is overloaded, the proportion of vacant slots tends to diminish accordingly. This version is the first version of framing protocol proposed to CATV protocols. It is a low interest since the performance are not very good. It can be noted that since contention period length is a fixed parameter, the IB packet could be restricted to its “granting” part. Figure 4 show an example of FRF frame with a fixed ratio of nine contention slots and nine data slots. In the displayed example only three data slots are granted.

3.2 Variable Ratio Framing protocols

These protocols are the immediate improvement of the fixed ratio protocols. In these protocols, hereafter nicknamed “VRF”, the frames are always of fixed length, but the ratio between contention and data varies in order to get rid

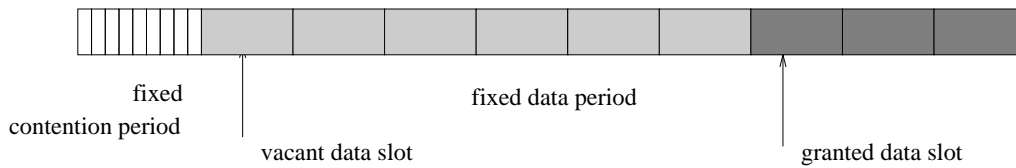

Figure 4: One FRF frame with vacant data slots (light grey) and granted data slots (dark grey).

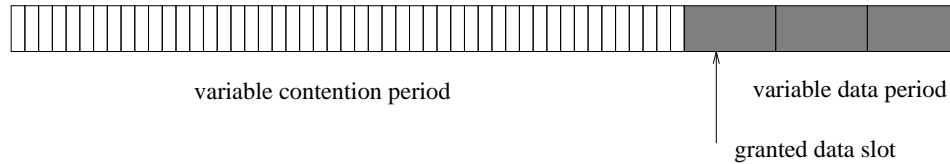

Figure 5: One VRF frame with variable contention and data periods.

of vacant data slots. Therefore IB packets must specify the length of the contention period for the incoming frame. The improvement is in the access protocol because it provides longer contention periods for the same loads and therefore less collision for the requests.

There is an alternative implementation half way from fixed ratio and variable ratio framing which allows less frequent update of contention period lengths. In this case the appropriate ratio is derived from equilibrium formula based on the estimate of the actual traffic load. This complicated version is of lower interest.

The VRF protocols are currently under study for CATV networks. Figure 5 shows an example of VRF frame, which is the equivalent of the FRF frame shown in figure 4 without vacant data slots. There are three data slots, all granted, versus fifty-one contention slots.

3.3 Variable Length Framing Protocols

This is the ultimate *explicit* framing protocol. In these protocols, hereafter nicknamed “VLF”, either the length and the ratio of the frame are variable, every parameter being updated in the IB packet. The ratio can be derived as in VRF version described below. The frame length could be optimized in order

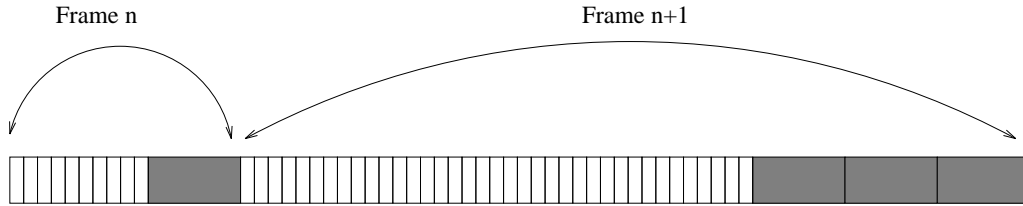

Figure 6: Two VLF frames with variable length and ratio.

to optimize average packet access delay. An example of such optimization will be given in the next section. Figure 6 shows two frames before and after a length change: the first frame has total length equivalent to sixteen contention slots, the second frame is fifty five contention slot long.

This kind of protocols has not yet been investigated for CATV networks. The impact of such optimizations will be investigated in a next section.

3.4 Minimal Implicit Framing protocols

These protocols belong to the *implicit* framing protocols class. We present the simplest version of this class (thereafter the name “minimal”). In these protocols, hereafter nicknamed “MIF”, the IB packet are omitted, in place there are sequence of *granting* packets (GR packets) which specify the schedules of each granted data slot. To simplify, we assume that each GR packet grants only one data slot. Contention periods are implicitly closed by the reception of GR packets. The effective close time is the earliest schedule received. GR packets are transmitted in time order so that schedule times are increasing. Granted slots are also allocated in FIFO order with respect to request reception times. Contention period restart when all current schedules have expired.

The advantage of the MIF protocols is that it allows asynchronous granting packets and more flexible management. There is no need to adapt the framing of the upstream channel to the existent downstream framing. The implicit framing adapt itself to the condition of traffics. There is less delay in channel access since the frames do not need to be larger than propagation larger R . In fact there can be several consecutive frames within one propagation delay and the late request effect is suppressed.

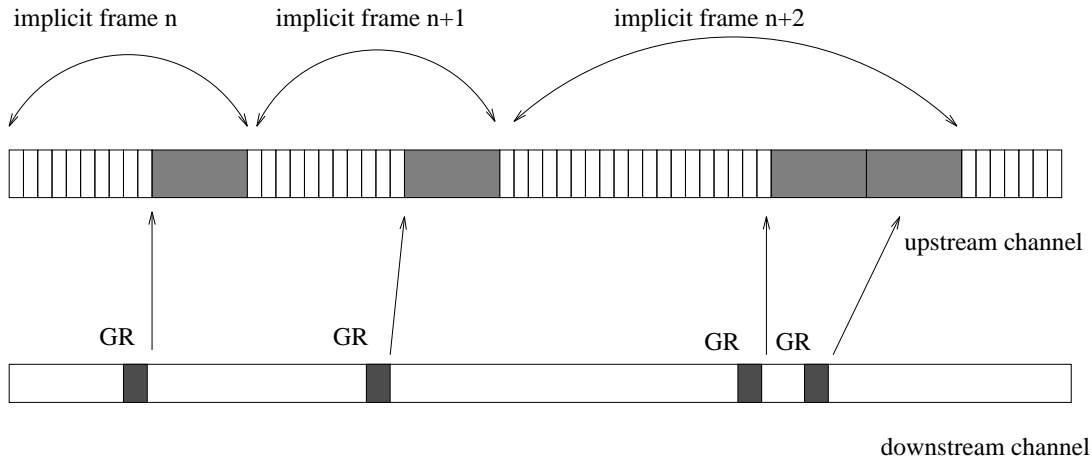

Figure 7: Implicit framing via asynchronous GR packets.

In counterpart, the MIF protocol generates more traffic on downstream channel since IB packets content is now dispatched in several GR packets, but downstream capacity is not considered limiting.

Figure 7 shows an example of implicit framing. The contention periods are closed by GR packets, notice that the schedule indicated in the GR packet can be independent of the time of reception, provided that it is in the future and that the time order is preserved.

4 Access delay analysis

4.1 Models

In this section we provide a short analysis of the access delays. We assume that the population of end-user is potentially infinite. We assume that all data slot lengths are identical, *e.g.* equal to one ATM cell and that one request holds for one packet. We assume a Poisson arrival of λ packets per time unit, equally distributed among all end-users. The time unit for λ will be the data slot length.

4.1.1 Piggybacking versus Channel transparency

We don't assume multi-request packet or request piggybacked on data slots because it won't impact access delay performance, since in non-overload condition end-user buffer are not expected to contain than one one pending packet.

This later condition is called "channel transparency". It is a natural consequence of the unboundness number of end-users and of the expected finiteness of access delays in non-overload conditions. Since the average time between the generation of two packets on the same end-user is virtually infinite (very large) compared to average access delay, then the buffer are not expected to contain more than one packet. Such condition is possible only if we use a contention protocols. A periodic TDMA is not channel transparent [3].

4.1.2 Large propagation delay asymptotic expansion

We assume that the propagation delay is very large and that we only retain from access delay the part proportional to R (when $R \rightarrow \infty$). This will emphasis the performance of the network when the delay propagation or the processing delay or the throughput are comparatively large.

In other words, if $W(\lambda, R)$ is the mean access delay as a function of traffic load λ and propagation delay R , then we are looking for $w(\lambda)$ such that for any fixed λ the following asymptotic expansion holds when $R \rightarrow \infty$: $W(\lambda, R) = R \times w(\lambda) + o(R)$ with $o(R)/R \rightarrow 0$ when $R \rightarrow \infty$. We call $w(\lambda)$ the asymptotic delay.

In CATV networks the upstream throughput is expected to be greater than several Mbps, the network size is limited to 80 km, and the processing delay on head-end may exceeds several ms.

4.1.3 Simplified collision resolution algorithm with capture

We are not focusing on collision resolution algorithm which is not expected to be the main determinant in framing protocols. In this first approach we only consider the simplification of contention protocol with capture: *i.e.* in each collision there is one request which is captured and correctly received by the head-end, the other requests being discarded. In this case the model is rather simple: for a traffic load of ρ requests per contention slot the probability for a

request to be discarded is exactly ρ . For a real collision resolution algorithm, the probability of collision would be strictly greater than ρ . Nevertheless, analyses with real collision resolution assumption are tractable and are currently under study, but will not be developed in the present paper.

We denote CS the length of a contention slot and DS the length of a data slot. Let λ_0 be the ratio between DS and $CS + DS$, therefore λ cannot exceed λ_0 . In implementation $DS = 7 * CS$ is a good target, therefore $\lambda_0 = 7/8$.

4.2 The FRF protocol

In this section we introduce the main line of reasoning which will be repeated several times all along this paper and which allows us to derive simple estimate of protocols, even when the later become more sophisticated.

First we denote by T the length of the frame. For explicit protocols we always assume that $T \geq R$. In the following we assume that T/R is equal or tends to a constant.

The data period of each frame is of length $\lambda_0 T$, and the remaining part of the frame used for contention is of length $(1 - \lambda_0)T$. Actual granted part of data period has average length λT , and we have $\lambda < \lambda_0$ to ensure stability.

Before entering in the details of the analysis, we assume an useful hypothesis, either for protocol efficiency and for analysis tractability: the *defer on data period* assumption. Packets generated during data periods are likely to jam on the beginning of the next contention period. Since the data period has length $\lambda_0 T$, the number of such packets will increases as $\lambda \lambda_0 T$ as $R \rightarrow \infty$, causing larger collisions and delays at the beginning of the next contention period. In order to cope with such phenomenon, it is usual to force all these waiting packets to dispatch themselves on the whole contention period via a random uniform backoff.

The key of the analysis will be the *Large Number Convergence* assumption. We assume that the Law of Large Number applies and that the length of actual granted part of the data period is a random variable which tends in distribution to λT , or in other word the granted length is in distribution $\lambda T + o(T)$ (we could probably be accurate and assume the whole Law of Large Number: $o(T) = O(\sqrt{T})$).

The limiting access delay $w(\lambda)$ is made of four parts:

1. the entrance delay: *i.e.* the additional delay when the packet is generated during a data period;
2. the collision delay: *i.e.* the delay in collision resolution before the request is successfully transmitted and the data slot is granted;
3. the transmission delay: *i.e.* the delay between the accepted request and the actual transmission of the data;
4. the exit delay.

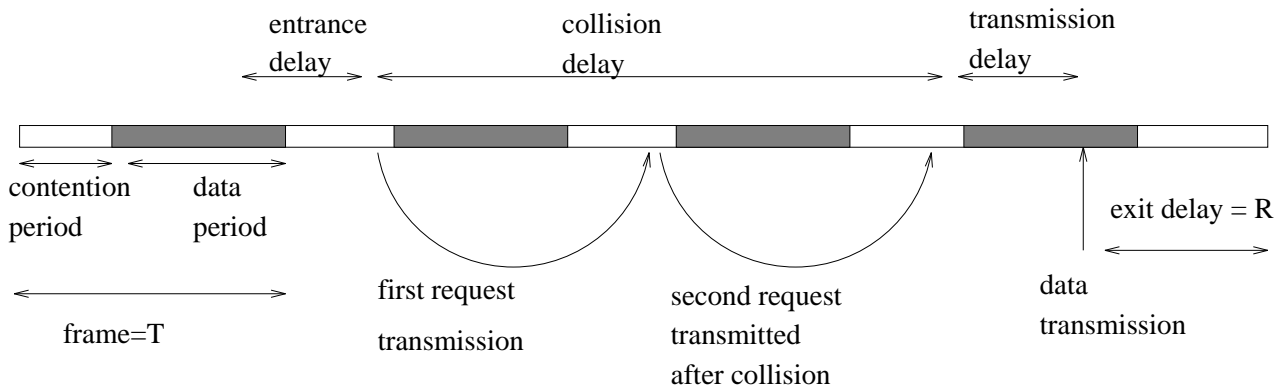

Figure 8: The four delay components.

Figure 8 illustrates this partition of access delays in four components.

The exit delay: is always set at R .

The entrance delay: with probability λ_0 a packet is generated during a data period; this packet must wait for the end of the data period, $\lambda_0 T/2$ and the random backoff lead to an additional delay of average $(1 - \lambda_0)T/2$. Therefore the contribution of the entrance delay is exactly $\lambda_0 T/2$.

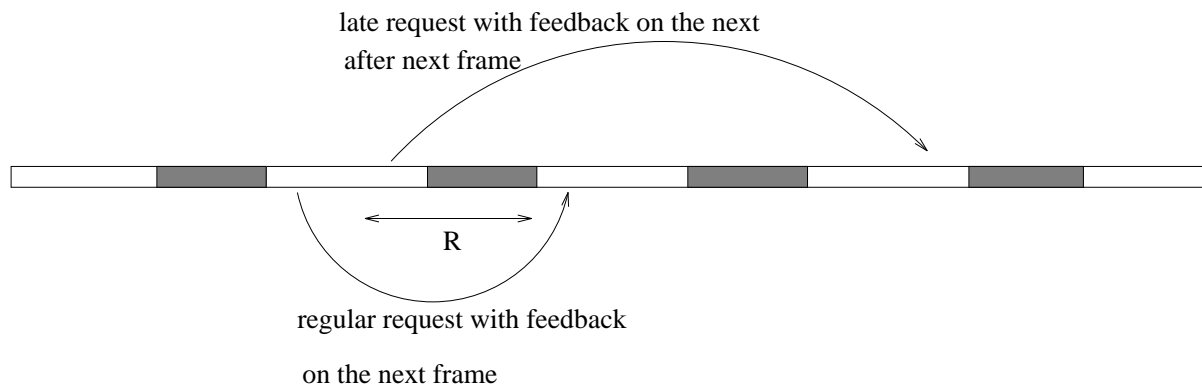

Figure 9: The late request effect in collision delay.

The collision delay. We distinguish two cases, corresponding to occurrence or non occurrence of late request.

First case: $\lambda_0 T \geq R$, therefore late requests are not possible. The average utilization of contention slots is λ/λ_0 , therefore the probability of a collision is λ/λ_0 which leads to retransmission until successful transmission. Each retransmission costs T , therefore the contribution in delay due to collision is in average $T\lambda/(\lambda_0 - \lambda)$. If we also take into consideration the cost due to the last successful transmission which is T , this cost becomes $T\lambda_0/(\lambda_0 - \lambda)$. The reader is referred to figure 8 for illustration.

Second case: $\lambda_0 T < T$, therefore late request are possible with probability θ_1 , quantity θ_1 is such that $\lambda_0 T + \theta_1(1 - \lambda_0)T = R$. In this case, each late request costs an additional T which basically means that the request is taken into consideration, regardless of collision or success, on the second after next frame. The contribution is now $(1 + \theta_1)T\lambda_0/(\lambda_0 - \lambda)$. Figure 9 illustrates the late request effect in collision access delay computation.

The transmission delay. This delay count the distance between the last request transmission time plus T (because T has already been counted in the collision delay) and the granted slot. The average remaining part of the contention period costs $(1 - \lambda_0)T/2$, the vacant data slots cost $(\lambda_0 - \lambda)T$, the average fraction of granted slots before transmission is $\lambda T/2$. Therefore the

average transmission delay is $T/2 + (\lambda_0 - \lambda)T/2$ therefore we can state the theorem:

Theorem 1 *The asymptotic average delay $w(\lambda)$ of FRF protocol has expression:*

- (i) If $\lambda_0 T \geq R$: $w(\lambda) = 1/R \left(\lambda_0 T/2 + \frac{\lambda_0 T}{\lambda_0 - \lambda} + T/2 + (\lambda_0 - \lambda)T/2 + R \right)$;
- (ii) If $\lambda_0 T < R$
 $w(\lambda) = 1/R \left(\lambda_0 T/2 + \frac{(1+\theta_1)\lambda_0 T}{\lambda_0 - \lambda} + T/2 + (\lambda_0 - \lambda)T/2 + R \right)$; with $\lambda_0 T + \theta_1(1 - \lambda_0)T = R$.

4.3 The VRF protocol

The VRF protocol accepts the same analysis as the FRF version but with the difference that the data period is now of length λT instead of $\lambda_0 T$, and the contention period is $(1 - \lambda)T$ and is supposed to converge to a constant for fixed λ as stated in the *Large Number Convergence*. In this case the average utilisation of contention slot is no longer $\rho = \lambda/\lambda_0$, but $\rho = \frac{(1-\lambda)\lambda}{(1-\lambda)\lambda_0}$.

We still have to distinguish two cases with respect to late request occurrence. The late requests occurs when $\lambda T \leq R$ which leads to the definition of a pivot value λ_1 for the input load such that $\lambda_1 = R/T$.

In the transmission delay the term $(\lambda_0 - \lambda)T/2$ which was present for the FRF protocol disappears for the VFR since there is no longer vacant data slots.

Theorem 2 *The asymptotic average delay $w(\lambda)$ of VRF protocol has expression:*

- (i) If $\lambda > \lambda_1 = R/T$:

$$w(\lambda) = 1/R \left(\lambda T/2 + \frac{(1 - \lambda)\lambda_0 T}{\lambda_0 - \lambda} + T/2 + R \right) ;$$

- (ii) If $\lambda \leq \lambda_1$

$$w(\lambda) = 1/R \left(\lambda T/2 + \left(1 + \frac{\lambda_1 - \lambda}{1 - \lambda}\right) \frac{(1 - \lambda)\lambda_0 T}{\lambda_0 - \lambda} + T/2 + R \right) .$$

4.4 The VLF protocol

This section consists in using the result for VRF protocol and to find an optimisation of frame length T in order to have the smaller access delay when λ is fixed. The computations are greatly helped by the fact that the access delay optimisation will lead to tractable second order expressions. We denote $T(\lambda)$ the optimized value of frame length T . A minor complication arises due to the existence of the two cases introduced by the quantity $\lambda_1 = R/T$.

First case: $\lambda \geq \lambda_1$, we have

Final case: $\lambda \leq \lambda_1$. Notice that the second case will lead to the actual optimisation since it also contains the optimisation of the first case with $\lambda_1 = \lambda$. We have now:

$$\begin{aligned} w(\lambda) &= \frac{1}{\lambda_1} \left(\lambda/2 + \left(1 + \frac{\lambda_1 - \lambda}{1 - \lambda}\right) \frac{(1 - \lambda)\lambda_0}{\lambda_0 - \lambda} + 1/2 \right) + 1 \\ &= \frac{1}{\lambda_1} \left(\lambda/2 + \frac{(1 - 2\lambda)\lambda_0}{\lambda_0 - \lambda} + 1/2 \right) + \frac{\lambda_0}{\lambda_0 - \lambda} + 1 . \end{aligned}$$

The actual optimisation will depend on the sign of the expression which is in factor of $\frac{1}{\lambda_1}$: $\lambda/2 + \frac{(1-2\lambda)\lambda_0}{\lambda_0-\lambda} + 1/2$. If the sign is negative then one should seek for the smallest λ_1 , *i.e.* $\lambda_1 = \lambda$. If the sign is positive, then one should seek for the largest λ_1 , *i.e.* $\lambda_1 = 1$. Provided that $\lambda_0 > 1/2$ there is only one value of λ which cancels the factor of $\frac{1}{\lambda_1}$, that is $\lambda_c = 1/2(3\lambda_0 + 1 + \sqrt{(3\lambda_0 + 1)^2 + 12\lambda_0})$. If $\lambda \leq \lambda_c$ then the factor is positive, and $\lambda_1 = 1$ prevails. Otherwise the factor is negative and $\lambda_1 = \lambda$ prevails.

Theorem 3 *The asymptotic average delay $w(\lambda)$ of VLF protocol has expression:*

- (i) *If $\lambda \leq \lambda_c = 1/2(3\lambda_0 + 1 + \sqrt{(3\lambda_0 + 1)^2 + 12\lambda_0})$, then*

$$w(\lambda) = 1/2(\lambda + 1) + \frac{2(1 - \lambda)\lambda_0}{\lambda_0 - \lambda} + 1 ,$$

and the optimised frame length is $T(\lambda) = R$.

- (ii) If $\lambda > \lambda_c$ then

$$w(\lambda) = \frac{1}{\lambda} \left(\frac{(1-\lambda)\lambda_0}{\lambda_0 - \lambda} + 1/2 \right) + 3/2 ,$$

and the optimised frame length is $T(\lambda) = \frac{1}{\lambda}R$.

4.5 The MIF protocol

In the MIF protocol the data periods are not forced to be proportional to propagation delay R as with the explicit framing protocols above described. In fact for a given $\lambda < \lambda_0$ the implicit frames are expected to keep a finite distribution when the propagation delay R tends to infinity. In other word the frame length is $o(R)$. Therefore both entrance delay and transmission delays are $o(R)$.

The average utilisation ρ of contention slots is still $\frac{(1-\lambda_0)\lambda}{(1-\lambda)\lambda_0}$. The average distance between two consecutive request retransmission is $R + o(R)$, due to eventual interferences with finite data periods. There is no late request effect and therefore the collision delay is $\frac{(1-\lambda)\lambda_0 R}{\lambda_0 - \lambda} + o(R)$.

Theorem 4 *The asymptotic average delay $w(\lambda)$ of MIF protocol has expression:*

$$w(\lambda) = \frac{(1-\lambda)\lambda_0}{\lambda_0 - \lambda} + 1$$

5 Numerical results

In this section we consider numerical application of the above theorems. We fixed data slots all equal to 7 times the contention slot, in order to fit ATM cells. Therefore $\lambda_0 = 7/8$ and $T = 3/2 \times R$ in FRF and VRF protocol.

Figure 10 displays quantities $w(\lambda)$ for λ varying from 0 to λ_0 , the later being the maximum utilization of the network in absence of piggybacking as explained in subsection 4.1.1.

Figure 11 is a magnification of the part of the previous figure contained in the box A. It shows the behaviour of VRF and VLF protocol when they are

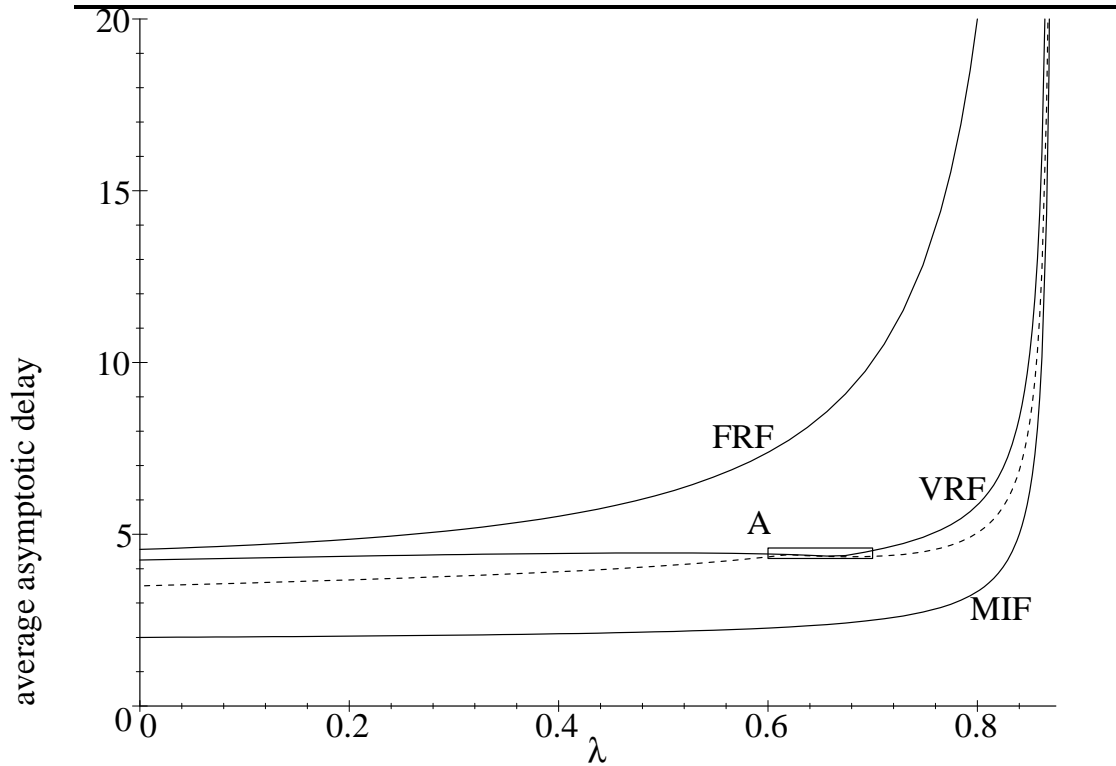

Figure 10: The average asymptotic delays for FRF, VRF, VLF and MIF protocols (VLF in dashed).

close together. In particular it shows that the value $T = 3T/2$ is optimal for two λ values.

Since MIF protocol is undoubtedly optimal for all ranges of λ , figure 12 shows the average redundancies of protocols FRF, VRF and VLF with respect to MIF, *i.e.* the figure display the ratio of the average access delay of each of the explicit with the average delay of the MIF protocol.

6 Conclusion

We have described four framing management schemes to share bandwidth of the upstream channel of CATV networks. We have studied these framing man-

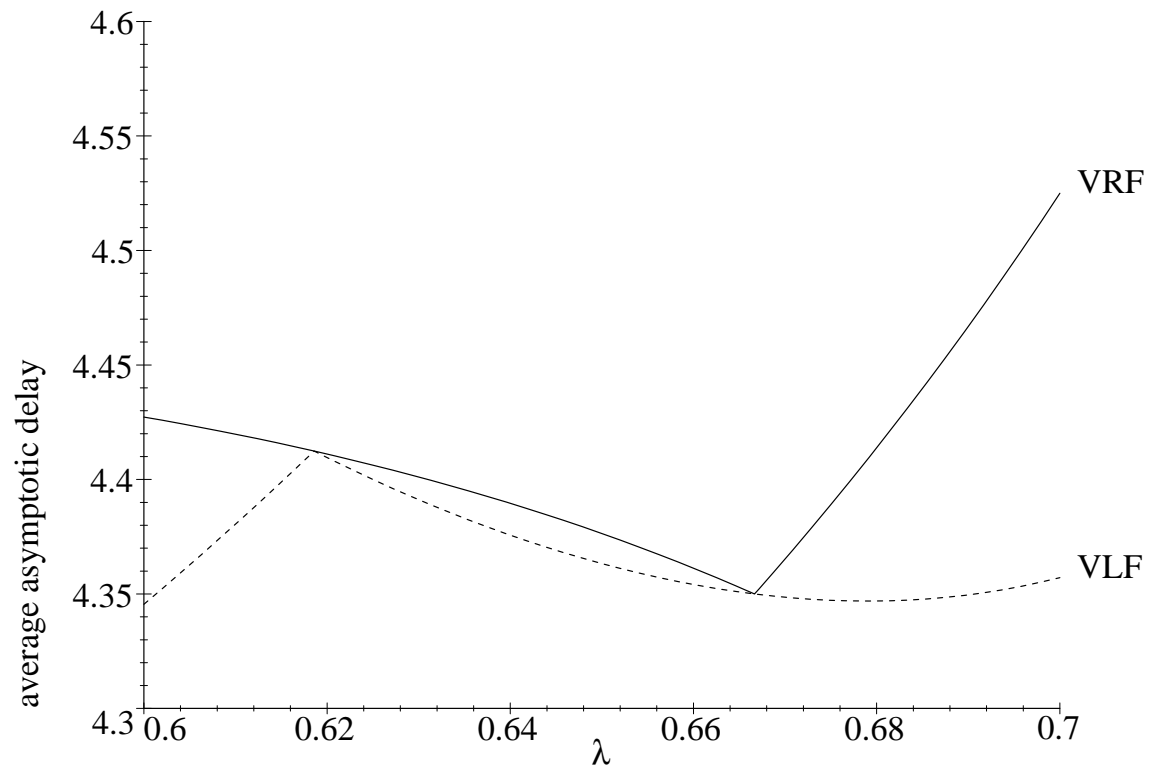

Figure 11: The average asymptotic delays for VRF and VLF protocols magnified from box A in figure 10.

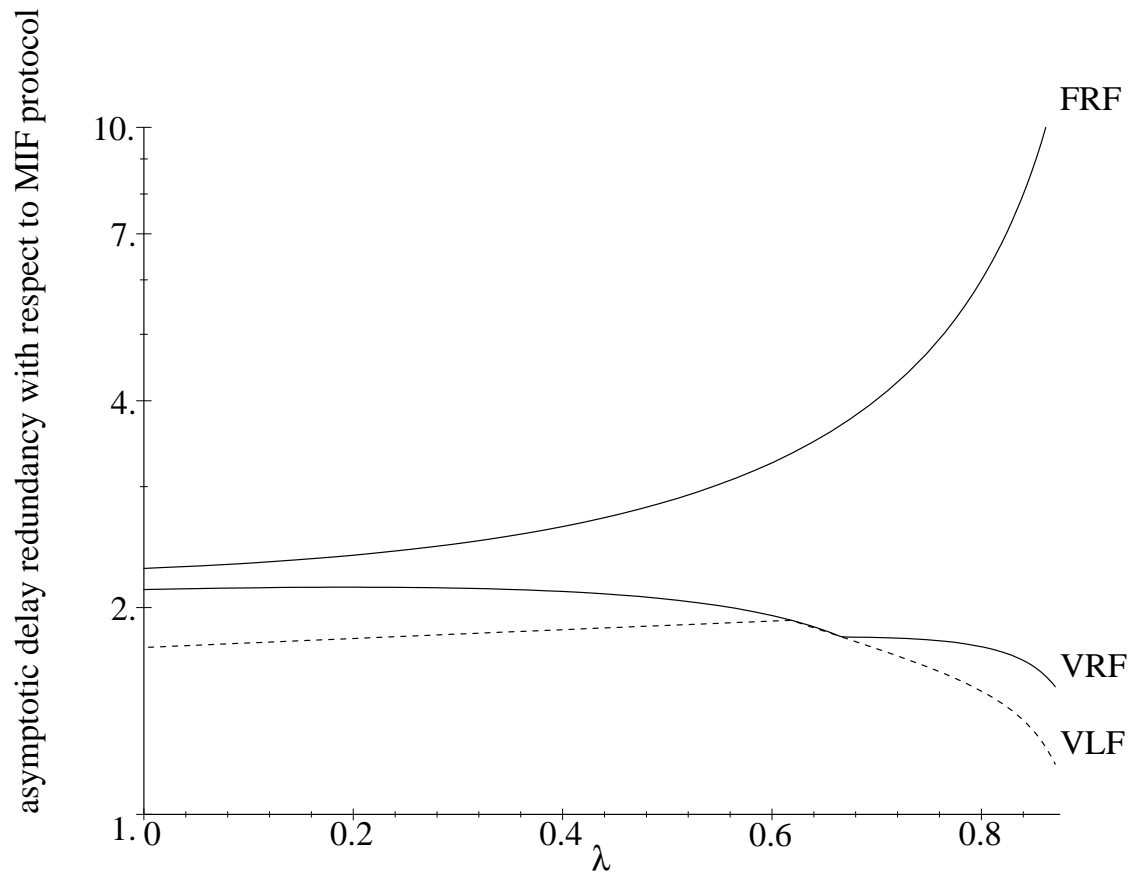

Figure 12: The relative redundancy in average delays of FRF, VRF, VLF versus MIF protocols.

agement schemes with simple analytical models. As a result of our simulation model, we have shown that implicit framing out performs explicit framing schemes. A detailed analysis in term of access delay has been provided.

References

- [1] Philippe Jacquet, Paul Mühlethaler and Philippe Robert “A slotted Medium Access Control Scheme designed for CATV Network” INRIA Research Report 4106. January 2001.
- [2] Philippe Jacquet, Paul Mühlethaler and Philippe Robert “Performant implementations of tree collision resolution algorithms for CATV networks” Research Report. 2001 to appear.
- [3] D. Bertsekas, R Gallager “Data networks” Prentice Hall. 1989.



Unit e de recherche INRIA Lorraine, Technop ole de Nancy-Brabois, Campus scientifique,
615 rue du Jardin Botanique, BP 101, 54600 VILLERS L ES NANCY
Unit e de recherche INRIA Rennes, Irista, Campus universitaire de Beaulieu, 35042 RENNES Cedex
Unit e de recherche INRIA Rh one-Alpes, 655, avenue de l'Europe, 38330 MONTBONNOT ST MARTIN
Unit e de recherche INRIA Rocquencourt, Domaine de Voluceau, Rocquencourt, BP 105, 78153 LE CHESNAY Cedex
Unit e de recherche INRIA Sophia-Antipolis, 2004 route des Lucioles, BP 93, 06902 SOPHIA-ANTIPOLIS Cedex

 diteur
INRIA, Domaine de Voluceau, Rocquencourt, BP 105, 78153 LE CHESNAY Cedex (France)
<http://www.inria.fr>
ISSN 0249-6399