



HAL
open science

Simultaneous Dominance Representation of Multiple Posets

J. Tanenbaum, Sue Whitesides

► **To cite this version:**

J. Tanenbaum, Sue Whitesides. Simultaneous Dominance Representation of Multiple Posets. RR-2624, INRIA. 1995. inria-00074062

HAL Id: inria-00074062

<https://inria.hal.science/inria-00074062>

Submitted on 24 May 2006

HAL is a multi-disciplinary open access archive for the deposit and dissemination of scientific research documents, whether they are published or not. The documents may come from teaching and research institutions in France or abroad, or from public or private research centers.

L'archive ouverte pluridisciplinaire **HAL**, est destinée au dépôt et à la diffusion de documents scientifiques de niveau recherche, publiés ou non, émanant des établissements d'enseignement et de recherche français ou étrangers, des laboratoires publics ou privés.

INSTITUT NATIONAL DE RECHERCHE EN INFORMATIQUE ET EN AUTOMATIQUE

*Simultaneous Dominance Representation of
Multiple Posets*

Paul J. Tanenbaum and Sue Whitesides

N° 2624

Juillet 1995

PROGRAMME 4



*Rapport
de recherche*



Simultaneous Dominance Representation of Multiple Posets

Paul J. Tanenbaum* and Sue Whitesides**

Programme 4 — Robotique, image et vision
Projet Prisme

Rapport de recherche n° 2624 — Juillet 1995 — 17 pages

Abstract: We characterize the *codominance pairs*—pairs of posets that admit simultaneous dominance representations in the (x, y) - and $(-x, y)$ -coordinate systems—and present a linear algorithm to recognize them and construct codominance representations. We define *dominance polysemy* as a generalization of codominance and describe several related problems and preliminary results.

Key-words: Computational geometry, Poset, Dominance

(Résumé : *tsvp*)

Research of P. Tanenbaum was supported in part by NSF grant CCR-9300079, also appears in the author's doctoral thesis written at the Johns Hopkins University under the supervision of Professors Edward R. Scheinerman and Michael T. Goodrich. Work of S. Whitesides was supported in part by an NSERC operating grant and an FCAR team grant,

*U.S. Army Research Laboratory, Aberdeen Proving Ground, Maryland 21005-5068 U.S.A.

**INRIA, B.P.93, 06902 Sophia-Antipolis cedex (France), and School of Computer Science, McGill University, 3480 University St. #318, Montréal, Québec H3A 2A7 Canada. sue@cs.mcgill.ca

Ensembles partiellement ordonnés admettant des représentations de dominance simultanés

Résumé : Nous caractérisons les *paires de codominance*— paires d'ensembles partiellement ordonnés admettant simultanément des représentations de dominance dans les systèmes de coordonnées (x, y) et $(-x, y)$ — et nous présentons un algorithme linéaire pour les reconnaître et construire les représentations de codominance. Nous définissons la *dominance polysemy* comme une généralisation de la codominance et décrivons quelques problèmes connexes ainsi que certains résultats préliminaires.

Mots-clé : Géométrie algorithmique, Ensemble partiellement ordonnés, Dominance

1 Introduction

Even the most fundamental relationships among simple geometric objects yield a wealth of challenging problems that reach throughout discrete mathematics. Examples abound in the thriving field of graph drawing [2, 4, 5, 8, 13, 14], which addresses not only the classical ball-and-stick model of graphs, but also representations based on such objects as line segments, n -balls, and discrete point sets with relations like intersection and proximity. Other examples arise from close kin to these geometric graphs: partial orders like containment and left-to-right precedence. They, too, have been studied widely [1, 6, 7, 12, 17]. One of the most important of these partial orders is dominance, a relation on \mathbf{R}^n that is well known in computational geometry [11]. Given points $\mathbf{p} = (p_1, \dots, p_n)$ and $\mathbf{q} = (q_1, \dots, q_n)$, we say that p dominates q provided

$$(p_1 \geq q_1) \wedge \dots \wedge (p_n \geq q_n). \tag{1}$$

An n -dominance representation of a partially ordered set (poset) $P = (X, \leq)$ for a positive integer n is a function $f: X \rightarrow \mathbf{R}^n$ such that for all $x, y \in X$, $x \leq y$ if and only if $f(x)$ is dominated by $f(y)$. Where there is no risk of ambiguity, we often refer to 2-dominance simply as dominance. Figure 1 illustrates a poset $P = (X, \leq)$ and a dominance representation f of P .

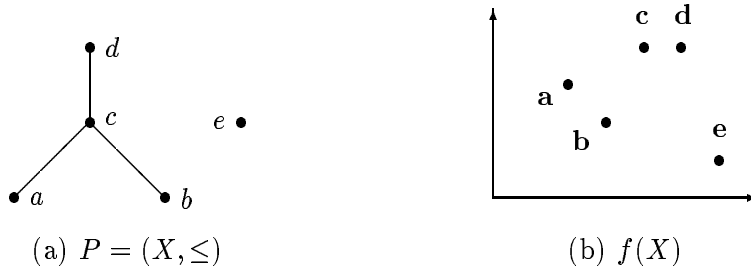

Figure 1: A poset P and a plane-dominance representation of P

It is clear from the definition that the dominance relation on a set $S \subseteq \mathbf{R}^n$ depends on both S and the orientation of the coordinate axes. In general, different orientations induce different partial orders. In this paper we consider those pairs (and eventually tuples) of partial orders on a common ground set that arise as the dominance relations on a set S for different coordinate systems. Each such partial order may be thought of as one of the *meanings* of S . This is an example of the phenomenon of poset polysemy, which we now describe in a more general setting.

The heart of the matter is the study of bijections between the ground set X of several posets P_1, \dots, P_k and another set Σ , which admits partial orders $\preceq_1, \dots, \preceq_k$ that are in some sense natural. Such a bijection f is *polysemic* provided that for all $x, y \in X$ and for $1 \leq i \leq k$,

$$x \leq_i y \text{ if and only if } f(x) \preceq_i f(y).$$

Poset polysemy, then, concerns the inherent partial orders on some set of interest, and specifically, the relationships among them. While the problems we address here are based on dominance, another example of poset polysemy arises from interval and interval-containment orders [16].

After some definitions and background information in section 2, we discuss a type of pairwise dominance polysemy in the plane that we call *codominance*. In section 3 we characterize the pairs of posets that admit codominance representations and in section 4 we present an algorithm that recognizes codominance pairs in linear time. In section 5 we discuss other types of dominance polysemy and present some related open problems.

2 Preliminaries

Let $P = (X, \leq)$ be a poset and $x, y \in X$. If either $x \leq y$ or $x \geq y$ we call x and y *comparable*. Otherwise, we call them *incomparable* and write $x \parallel y$. If $Y \subseteq X$, then the *restriction* of P to Y —also called the subposet of P induced by Y —is the poset $P[Y] = (Y, \leq')$ where for any $x, y \in Y$, $x \leq' y$ if and only if $x \leq y$. The *dual* of P is the poset $P^d = (X, \geq)$ obtained by reversing all the comparabilities of P .

A poset $P = (X, \leq)$ is a *chain* (also called a *linear order*) provided that for all $x, y \in X$ either $x \leq y$ or $x \geq y$. The *antichain* on X is the poset (X, \emptyset) . A *linear extension* of a poset $P = (X, \leq_P)$ is a chain $L = (X, \leq_L)$ for which $x \leq_L y$ whenever $x \leq_P y$. Linear extensions are essentially equivalent to topological sorts. Dushnik and Miller [3] defined the *dimension* $\dim(P)$ of a poset $P = (X, \leq)$ as the size of a smallest set of linear orders on X whose intersection is \leq . They also showed that $\dim(P)$ is the smallest d for which P has a d -dominance representation, thus justifying the choice of the term *dimension*.

If $P_1 = (X, \leq_1)$ and $P_2 = (X, \leq_2)$ are posets, then for any distinct $x, y \in X$ there is a unique ordered pair (R_1, R_2) such that $x R_1 y$ and $x R_2 y$ for $R_1 \in \{<_1, \parallel_1, >_1\}$ and $R_2 \in \{<_2, \parallel_2, >_2\}$. Thus the ordered pair (P_1, P_2) induces nine relations on X , of which some may, in general, be empty. We introduce notation for these relations in table 1. As an example, $x \parallel\!> y$ means $x \parallel_1 y$ and $x >_2 y$.

	$<_2$	\parallel_2	$>_2$
$<_1$	\ll	$\langle\parallel$	\diamond
\parallel_1	$\parallel\langle$	$\#$	$\parallel\rangle$
$>_1$	\times	$\rangle\parallel$	\gg

 Table 1: The nine relations from $<_1$ and $<_2$ on X

For any $\mathbf{p}, \mathbf{q} \in \mathbf{R}^2$ with $\mathbf{p} = (p_1, p_2)$ and $\mathbf{q} = (q_1, q_2)$, we say that \mathbf{p} *right-dominates* \mathbf{q} whenever $(p_1 \leq q_1) \wedge (p_2 \geq q_2)$. Likewise, where there is any risk of ambiguity, we refer to the conventional notion of dominance defined in (1) as *left-dominance*. Note that two points are incomparable under (left-)dominance if and only if they differ in both coordinates in such a way that the point with the larger x -coordinate has the smaller y -coordinate. But in that case the two are comparable under right-dominance. This yields the following result.

Lemma 1 *Every pair $\mathbf{p}, \mathbf{q} \in \mathbf{R}^2$ is comparable under at least one of left- and right-dominance. \square*

3 Characterization of Codominance Pairs

Lemma 1 has an equivalent restatement in terms of the relations in table 1: Given the posets (\mathbf{R}^2, \leq_1) and (\mathbf{R}^2, \leq_2) , where \leq_1 and \leq_2 are respectively left- and right-dominance, $\#$ is empty. What more can be said about the interrelation between the left- and right-dominance relations on a set of points in the plane? That is the first problem in poset polysemy that we address. For any posets $P_1 = (X, \leq_1)$ and $P_2 = (X, \leq_2)$ on some set X , the ordered pair (P_1, P_2) is a *codominance pair* on X provided that there exists a function $f: X \rightarrow \mathbf{R}^2$ taking $x_i \in X$ to $\mathbf{x}_i \in \mathbf{R}^2$ such that

$$\begin{aligned}
 x_i \leq_1 x_j & \text{ if and only if } \mathbf{x}_i \text{ is left-dominated by } \mathbf{x}_j \\
 & \text{and} \\
 x_i \leq_2 x_j & \text{ if and only if } \mathbf{x}_i \text{ is right-dominated by } \mathbf{x}_j.
 \end{aligned}$$

In this case, the function f is called a *codominance representation* of (P_1, P_2) .

Codominance is closely related to the graph-theoretic idea of representation by rectangles of influence [5]. A graph $G = (V, E)$ is a rectangle-of-influence graph

provided that $V \subset \mathbf{R}^2$ and that $u, v \in V$ are adjacent in G if and only if no point in $V \setminus \{u, v\}$ is within the minimum axis-aligned box containing u and v .

Observation 2 (P_1, P_2) is a codominance pair if and only if (P_2, P_1) is.

In light of observation 2, it is reasonable to say in such a case that P_1 and P_2 are *codominant*.

If (P_1, P_2) is a codominance pair on a set X and $x, y \in X$, then as we have seen, $x R y$ for exactly one relation R in table 1. This relation tightly constrains the relative positions of $\mathbf{x} = f(x)$ and $\mathbf{y} = f(y)$ for any codominance representation f of (P_1, P_2) . In fact there is a bijection, as given in table 2, between pairs $R = (R_1, R_2)$ and relative position of \mathbf{x} and \mathbf{y} . We call \ll , \diamond , \times , and \gg the *axial* relations of

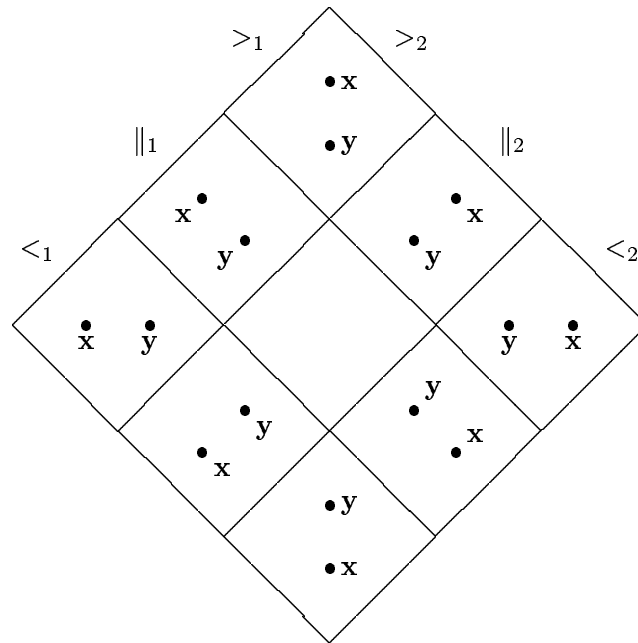

Table 2: Point positions and comparabilities in P_1 and P_2

(P_1, P_2) because they imply that pairs of elements lie on horizontal or vertical lines. Table 2 also constitutes a proof that codominance representations are unique to within addition or subtraction of empty horizontal and vertical bands. For details see [15].

Observation 3 Let P be any poset. Then (P, P) is a codominance pair if and only if P is a chain.

Lemma 4 Let posets $P_1 = (X, \leq_1)$ and $P_2 = (X, \leq_2)$ be codominant. If $x, y, z \in X$ with $x <_1 y <_1 z$ and $x \perp_2 z$, then either $x <_2 y <_2 z$ or $z <_2 y <_2 x$.

PROOF. Let f be a codominance representation of (P_1, P_2) . Since $x <_1 z$ and $x \perp_2 z$, the directed line segment from $\mathbf{x} = f(x)$ to $\mathbf{z} = f(z)$ must point, as table 2 shows, in an axial direction, either rightward or upward. Since y is comparable to both in P_1 , the point $\mathbf{y} = f(y)$ must lie in the interior of segment $\overline{\mathbf{x}\mathbf{z}}$. This implies either one or the other of the conclusions, depending whether $\overline{\mathbf{x}\mathbf{z}}$ is vertical or horizontal. ■

We now present four theorems that further illuminate the constraints on codominance pairs. These theorems all deal with 3-element restrictions of a codominance pair, which is to say pairs of the form $(P_1[Y], P_2[Y])$, where $P_1 = (X, \leq_1)$ and $P_2 = (X, \leq_2)$ are codominant and $Y \subseteq X$ with $|Y| = 3$.

Theorem 5 If posets $P_1 = (X, \leq_1)$ and $P_2 = (X, \leq_2)$ are codominant and $x <_1 y <_1 z$ is a chain in P_1 , then the subposet of P_2 induced by $\{x, y, z\}$ is none of the posets in figure 2.

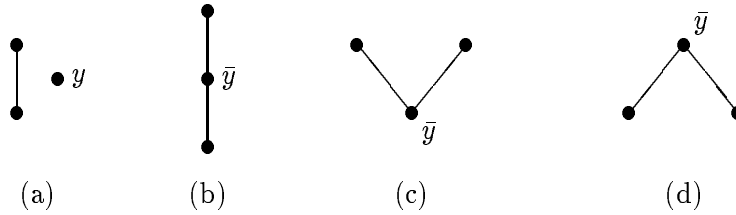

[NOTE: \bar{y} means either x or z .]

Figure 2: Theorem 5

PROOF. Follows from lemma 4. ■

Theorem 6 If posets $P_1 = (X, \leq_1)$ and $P_2 = (X, \leq_2)$ are codominant and $x, y, z \in X$ such that $x \perp_1 y, y \perp_1 z$, but $x \parallel_1 z$ then the subposet of P_2 induced by $\{x, y, z\}$ is none of the posets in figure 3.

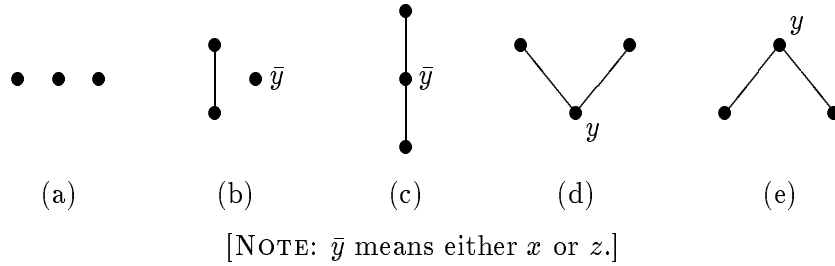

Figure 3: Theorem 6

PROOF. Restrictions (a), (b), (d), and (e) are forbidden by lemma 1, so consider (c). If the restriction P' of P_2 to $\{x, y, z\}$ is a chain, then x and y are comparable in both P_1 and P_2 , so (x, y) must be in one of the axial relations. A similar argument shows that (y, z) , too, must be in one of the axial relations. Then since $x \parallel_1 z$, one of the line segments \overline{xy} and \overline{yz} must be horizontal and the other vertical. Thus if P' is a chain, then y is neither the minimum nor the maximum, so (c) is also forbidden. ■

Theorem 7 *If posets $P_1 = (X, \leq_1)$ and $P_2 = (X, \leq_2)$ are codominant and $x, y, z \in X$ such that $x <_1 z$, $x \parallel_1 y$, and $y \parallel_1 z$, then the subposet of P_2 induced by $\{x, y, z\}$ is none of the posets in figure 4.*

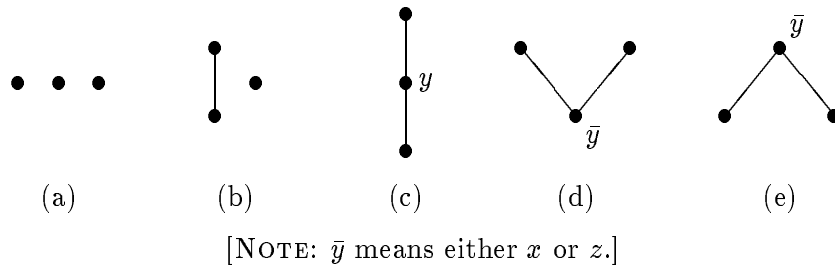

Figure 4: Theorem 7

PROOF. Restrictions (a), (b), (d), and (e) are forbidden by lemma 1, and (c) by theorem 5. ■

Theorem 8 *If posets $P_1 = (X, \leq_1)$ and $P_2 = (X, \leq_2)$ are codominant and $\{x, y, z\}$ is an antichain in P_1 , then the subposet of P_2 induced by $\{x, y, z\}$ is none of the posets in figure 5.*

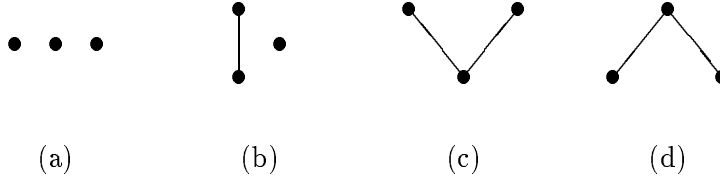

Figure 5: Theorem 8

PROOF. Follows from lemma 1. ■

Theorems 5–8 are summarized in table 3. Consider posets $P_1 = (X, \leq_1)$ and $P_2 = (X, \leq_2)$ and $Y = \{y_1, y_2, y_3\} \subseteq X$. The restriction $P_1[Y]$ has one of the five morphologies displayed along the left edge of the table. The vee and wedge shapes are equivalent in this context and thus correspond to a single class. Likewise, $P_2[Y]$ falls into one of the four morphology classes along the top edge of the table. Each of the first three classes has a distinguished element, which is drawn open while the others are drawn solid. Now classify the triple Y as type- ij , where $P_1[Y]$ has morphology i and $P_2[Y]$ has morphology j . The ij th entry in the body of the table then indicates the required relationship between the distinguished elements of the two restrictions. The crosshatched entries correspond to empty classes and appear at the lower right because in these cases $P_1[Y]$ and $P_2[Y]$ combined have fewer than the three comparabilities necessary to keep $\#$ empty. Table 4 likewise summarizes lemma 1. The fact that tables 3 and 4 are symmetric is a consequence of observation 2. Henceforth, and because of this symmetry, we shall refer only to the top half of table 3 (triples of type- ij , where $1 \leq i \leq j \leq 3$) and rely on this equivalence between type- ij and type- ji .

Tables 3 and 4 are not only necessary conditions, but also sufficient conditions for codominance.

Theorem 9 *Posets $P_1 = (X, \leq_1)$ and $P_2 = (X, \leq_2)$ are codominant if and only if there exist no $x, y \in X$ with $x \# y$ and for every chain $x <_i y <_i z$ of P_i ($i = 1, 2$), the restriction $P_{3-i}[\{x, y, z\}]$ is none of the posets in figure 6.*













				
	same	same	different	any
	same	different	same	
	different	same		
	any			

Table 3: Three-element restrictions of codominance pairs

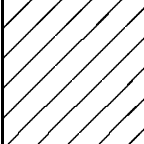

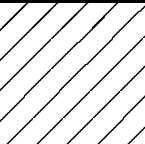
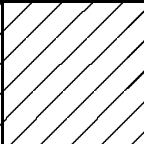

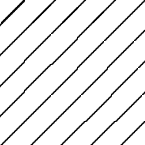
		
	any	any
	any	

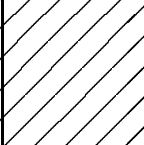
Table 4: Two-element restrictions of codominance pairs

 Figure 6: Forbidden three-element restrictions for posets codominant with $x < y < z$

PROOF SKETCH. Every codominance pair meets the conditions—this follows from lemma 1 and theorems 5–8. The converse can be shown by induction on the size of X . Given a pair (P_1, P_2) that meets the conditions and given a codominance representation f of $(P_1 - x, P_2 - x)$ for any x that is maximal in P_1 , one can—by extending f —create a codominance representation for (P_1, P_2) . The complete proof may be found in [15]. ■

4 Recognizing Codominance Pairs

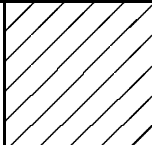
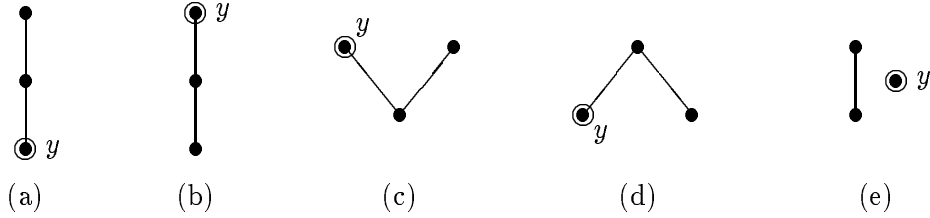
Let \leq_1 and \leq_2 be two partial orders on a finite set X (without loss of generality $X = [n]$) and let $m = |\leq_1| + |\leq_2|$. We present an algorithm that decides in $O(n + m)$ time and $O(n + m)$ space whether (P_1, P_2) is a codominance pair, where $P_1 = (X, \leq_1)$, $P_2 = (X, \leq_2)$. If so, then the algorithm produces a codominance representation that maps $1 \leq k \leq n$ to $\mathbf{k} = (x_k, y_k) \in \mathbf{R}^2$.

X is represented in the input by the value n , and \leq_i is represented by a list or ordered pairs in which (k, ℓ) signifies that $k \leq_i \ell$. The pairs are counted as they are read, and if $m < \binom{n}{2}$ then the algorithm trivially rejects the input based on lemma 1.

For each $k \in X$ the algorithm iteratively tightens real-valued bounds on the values of x_k and y_k . The initial bounds on each \mathbf{k} are $-\infty \leq x_k \leq \infty$ and $-\infty \leq y_k \leq \infty$. The main body of the algorithm is the loop in figure 7. The algorithm makes it out of the loop without rejecting the input precisely when (P_1, P_2) is a codominance pair. While the loop requires $\Theta(n^2)$ time, lemma 1 shows that merely reading the input requires $\Omega(n^2)$ time for any codominance pair. So the running time for the algorithm is optimal, and is in fact $O(n + m)$. The space required is clearly also $O(n + m)$. Furthermore, the algorithm can produce a codominance representation on the integer grid by simply sorting the points on x and y . This produces (in asymptotically negligible time and space) a drawing of (P_1, P_2) in an

```

Algorithm Recognize_Codominance
while  $X \neq \emptyset$ 
  remove some  $k$  from  $X$ ;
  select values for  $x_k$  and  $y_k$ ;
  ▷ These values may be selected arbitrarily,
  ▷ provided that they satisfy the current bounds on  $\mathbf{k}$ .
  for all  $\ell \in X$ 
    update bounds on  $x_\ell$  and  $y_\ell$ ;
    ▷ Update is based on relationship between
    ▷  $k$  and  $\ell$  in  $P_1$  and  $P_2$ , as summarized in table 2.
  if updated bounds are infeasible
    reject  $(P_1, P_2)$ ;

```

Figure 7: The recognition algorithm for codominance pairs

$n \times n$ grid, which may be seen to be optimal by the example of a chain and an antichain on $[n]$.

5 Other Types of Dominance Polysemy

There are several reasonable directions in which to extend the exploration of dominance polysemy. We shall describe three such directions and present some basic results for two of them.

5.1 Orthodominance

As is well known, a 2-dominance representation g for a poset $P = (X, \leq)$ induces a pair of weak orders on X . One of them orders X by the x -coordinates of $g(X)$ and the other by the y -coordinates. Note that if both the x - and the y -coordinates are unique, then these orders are linear extensions of P and their intersection is \leq . A codominance representation f for a pair (P_1, P_2) of posets, providing as it does a simultaneous dominance representation for each poset separately, induces two such pairs of weak orders:

$$\begin{aligned} \mathcal{W}_1 &= (W_{x_1}, W_{y_1}) \text{ from } P_1 \\ &\text{and} \\ \mathcal{W}_2 &= (W_{x_2}, W_{y_2}) \text{ from } P_2. \end{aligned}$$

The key feature of codominance representations is that

$$\begin{aligned} W_{y_1} &= W_{y_2} \\ &\text{and} \\ W_{x_1} &= (W_{x_2})^d. \end{aligned} \tag{2}$$

By relaxing the constraints (2) we can obtain different notions of polysemic dominance pairs. One way to do that is to eliminate the duality between W_{x_1} and W_{x_2} , allowing them to be completely independent. In doing so we arrive at the notion of orthodominance, which we proceed now to define rigorously.

Let $\pi_{xz}, \pi_{yz}: \mathbf{R}^3 \rightarrow \mathbf{R}^2$ be the orthogonal-projection functions mapping any $\mathbf{p} = (a, b, c) \in \mathbf{R}^3$ to $\pi_{xz}(\mathbf{p}) = (a, c)$ and $\pi_{yz}(\mathbf{p}) = (b, c)$. For any set $X = \{v_1, \dots, v_n\}$ and posets $P_1 = (X, \leq_1)$ and $P_2 = (X, \leq_2)$, the ordered pair (P_1, P_2) is an *orthodominance pair* on X provided that there exists a function $f: X \rightarrow \mathbf{R}^3$ taking $v_i \in X$ to $\mathbf{v}_i \in \mathbf{R}^3$ such that

$$\begin{aligned} v_i \leq_1 v_j &\text{ if and only if } \pi_{xz}(\mathbf{v}_i) \text{ is left-dominated by } \pi_{xz}(\mathbf{v}_j) \\ &\text{and} \\ v_i \leq_2 v_j &\text{ if and only if } \pi_{yz}(\mathbf{v}_i) \text{ is left-dominated by } \pi_{yz}(\mathbf{v}_j). \end{aligned}$$

In this case, the function f is called an *orthodominance representation* of (P_1, P_2) and P_1 and P_2 are said to be *orthodominant*.

Figure 8 illustrates an orthodominance representation of a chain and an anti-chain on a 2-set. As another example, P_1 and P_2 as illustrated in figure 9 are not orthodominant, for suppose (P_1, P_2) had an orthodominance representation mapping u, v , and w to $\mathbf{u} = (u_1, u_2, u_3)$, \mathbf{v} , and $\mathbf{w} = (w_1, w_2, w_3)$, respectively. It would follow from $u \not\# w$ that $u_3 \neq w_3$. But in order for $v \times u$ and $v \times w$, \mathbf{v} would have to be in both the $z = u_3$ and the $z = w_3$ planes.

Theorem 10 *The set of orthodominance pairs on any set X is a reflexive symmetric relation on the posets on X of dimension 2 or less. However, the relation need not be transitive.*

PROOF. Symmetry is trivial. As for reflexivity, let P be a poset on X for which there exists a (left-)dominance representation that maps each $v_i \in X$ to (a_i, b_i) . Then the function $f: X \rightarrow \mathbf{R}^3$ defined by $f(v_i) = (a_i, a_i, b_i)$ is an orthodominance representation of (P, P) .

Now suppose P_1, P_2 , and P_3 are as illustrated in figure 10. Then (P_1, P_2) and

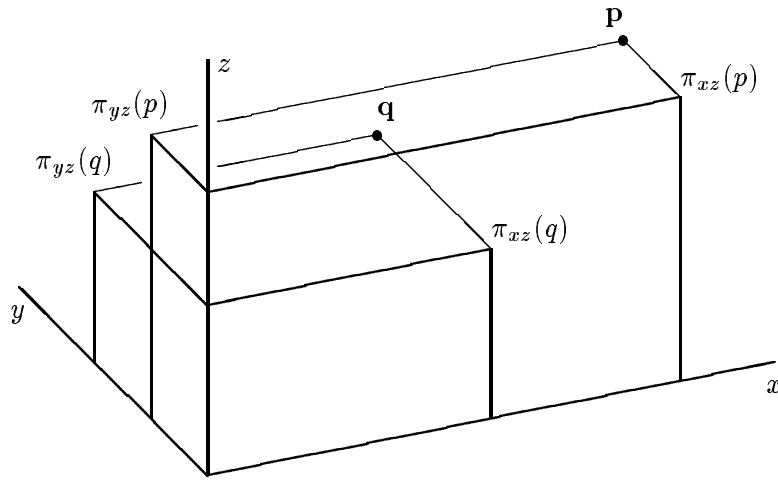

Figure 8: An orthodominance representation of $p >|| q$

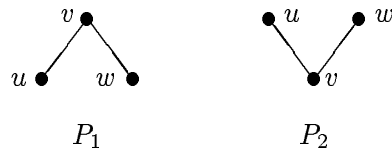

Figure 9: Nonorthodominant posets

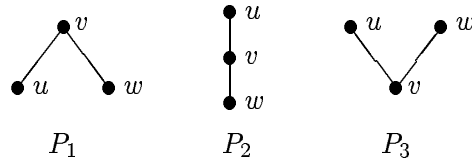

Figure 10: Orthodominance is not transitive

(P_2, P_3) have the orthodominance representations

$$\begin{array}{l}
 u \mapsto (1, 2, 2) \\
 v \mapsto (2, 1, 2) \\
 w \mapsto (2, 1, 1)
 \end{array}
 \quad \text{and} \quad
 \begin{array}{l}
 u \mapsto (2, 1, 2) \\
 v \mapsto (2, 1, 1) \\
 w \mapsto (1, 2, 1)
 \end{array}$$

respectively, but as the previous example showed, (P_1, P_3) is not an orthodominance pair. ■

The next theorem captures the fact that the idea of orthodominance was obtained by relaxing (2), the codominance constraint.

Theorem 11 *The codominance pairs on any set X form a subset of the orthodominance pairs on X . If $|X| \geq 3$, then this containment is proper.*

PROOF. Let P_1 and P_2 be posets on X such that there exists a codominance representation of (P_1, P_2) that maps each $v_i \in X$ to (a_i, b_i) . Without loss of generality, $0 < a_i < 1$. Then the function $f: X \rightarrow \mathbf{R}^3$ defined by $f(v_i) = (a_i, 1 - a_i, b_i)$ is an orthodominance representation of (P_1, P_2) .

On the other hand, if P_1 and P_2 are as illustrated in figure 11, then (P_1, P_2) has



Figure 11: Orthodominance does not imply codominance

the orthodominance representation

$$\begin{aligned} u &\mapsto (2, 1, 2) \\ v &\mapsto (1, 2, 2) \\ w &\mapsto (1, 1, 1), \end{aligned}$$

but has no codominance representation since it violates the type-1,1 constraint of theorem 9.

5.2 Circular Sequences of Posets

Goodman and Pollack [9, 10] introduced the *circular sequence* of a set S of n points in the plane: the cycle of permutations of $[n]$ obtained by labeling the points in S and projecting them onto a line that rotates through 360 degrees. We generalize the linear orders (permutations) of their definition to arbitrary partial orders of dimension 2 or less, obtaining specifically the *circular dominance sequence* of S : the cycle of left-dominance relations obtained by rotating the x - and y -axes through 360 degrees.

For S a 3-set, we can easily produce distinct *circular-sequential dominance tuples* by making S the vertices of a triangle that is either acute, right, or obtuse. The result is three 12-tuples, which is to say lists of a dozen posets (for details see [15]). It is no coincidence that all three tuples have length 12. A circular dominance sequence has period bounded in much the same way as have the circular [permutation] sequences [9].

Observation 12 *The period of the circular dominance sequence of any n -set $S \subset \mathbf{R}^2$, which is to say the length of the circular-sequential dominance tuple induced by S , is at most $4\binom{n}{2}$.*

5.3 Generalized Codominance

A third way in which to extend the exploration of dominance polysemy is to generalize the notion of codominance to higher dimensions. But even here there are several possible generalizations. One generalization to \mathbf{R}^n is based on the $\binom{n}{2}$ orthogonal-projection functions $\pi_{ij}: \mathbf{R}^n \rightarrow \mathbf{R}^2$ for $1 \leq i < j \leq n$ that map $\mathbf{p} = (p_1, \dots, p_n) \in \mathbf{R}^n$ to $(p_i, p_j) \in \mathbf{R}^2$. It considers those $\binom{n}{2}$ -tuples $(P_{\{1,2\}}, P_{\{1,3\}}, \dots, P_{\{n-1,n\}})$ of posets on a common ground set X for which there exist functions $f: X \rightarrow \mathbf{R}^n$ such that $\pi_{ij} \circ f$ is a dominance representation for $P_{\{i,j\}}$ for all $1 \leq i < j \leq n$.

Another generalization to \mathbf{R}^n is based on a partition $n_1 + \dots + n_k$ of n and on the 2^n orthogonal-projection functions $\pi_S: \mathbf{R}^n \rightarrow \mathbf{R}^t$ for the t -set $S = \{s_1, \dots, s_t\} \subseteq [n]$ that map $\mathbf{p} = (p_1, \dots, p_n) \in \mathbf{R}^n$ to $(p_{s_1}, \dots, p_{s_t}) \in \mathbf{R}^t$. It considers those k -tuples (P_1, \dots, P_k) of posets on a common ground set X for which there exist functions $f: X \rightarrow \mathbf{R}^n$ such that $\pi_{\{1, \dots, n_1\}} \circ f$ is an n_1 -dominance representation for P_1 , $\pi_{\{n_1+1, \dots, n_1+n_2\}} \circ f$ is an n_2 -dominance representation for P_2 , and so on. When such a polysemic representation exists, it is clear that $\dim(P_i) \leq n_i$ for $i = 1, \dots, k$.

References

- [1] G. Brightwell and P. Winkler, *Sphere orders*, Order **6** (1989), 235–240.
- [2] G. R. Brightwell and E. R. Scheinerman, *Representations of planar graphs*, SIAM J. Discrete Math. **6** (1993), no. 2, 214–229.
- [3] B. Dushnik and E. W. Miller, *Partially ordered sets*, Amer. J. Math. **63** (1941), 600–610.

-
- [4] G. Ehrlich, S. Even, and R. E. Tarjan, *Intersection graphs of curves in the plane*, J. Combin. Theory Ser. B **21** (1976), 8–20.
- [5] H. El Gindy, G. Liotta, A. Lubiw, H. Meijer, and S. Whitesides, *Recognizing rectangle of influence drawable graphs*, In Tamassia and Tollis [14], pp. 352–363.
- [6] P. C. Fishburn, *Interval orders and interval graphs: A study of partially ordered sets*, John Wiley, New York, 1985.
- [7] P. C. Fishburn and W. T. Trotter, Jr., *Angle orders*, Order **1** (1985), 333–343.
- [8] P. C. Gilmore and A. J. Hoffman, *A characterization of comparability graphs and of interval graphs*, Canad. J. Math. **16** (1964), 539–548.
- [9] J. E. Goodman and R. Pollack, *On the combinatorial classification of non-degenerate configurations in the plane*, J. Combin. Theory Ser. A **29** (1980), 220–235.
- [10] ———, *Semispaces of configurations, cell complexes of arrangements*, J. Combin. Theory Ser. A **37** (1984), 257–293.
- [11] F. P. Preparata and M. I. Shamos, *Computational geometry: An introduction*, Springer-Verlag, New York, 1985.
- [12] E. R. Scheinerman, *A note on planar graphs and circle orders*, SIAM J. Discrete Math. **4** (1991), no. 3, 448–451.
- [13] J. Spinrad, *Recognition of circle graphs*, J. Algorithms **16** (1994), 264–282.
- [14] R. Tamassia and I. G. Tollis (eds.), *Graph drawing: Proceedings of GD '94*, Lecture Notes in Computer Science, no. 894, Berlin, Springer-Verlag, 1995.
- [15] P. J. Tanenbaum, *On geometric representations of partially ordered sets*, Ph.D. thesis, The Johns Hopkins University, 1995.
- [16] ———, *Simultaneous representation of interval and interval-containment orders*, (1995).
- [17] P. J. Tanenbaum, M. T. Goodrich, and E. R. Scheinerman, *Characterization and recognition of point-halfspace and related orders*, In Tamassia and Tollis [14], pp. 234–245.



Unité de recherche INRIA Lorraine, Technopôle de Nancy-Brabois, Campus scientifique,
615 rue du Jardin Botanique, BP 101, 54600 VILLERS LÈS NANCY
Unité de recherche INRIA Rennes, Irisa, Campus universitaire de Beaulieu, 35042 RENNES Cedex
Unité de recherche INRIA Rhône-Alpes, 46 avenue Félix Viallet, 38031 GRENOBLE Cedex 1
Unité de recherche INRIA Rocquencourt, Domaine de Voluceau, Rocquencourt, BP 105, 78153 LE CHESNAY Cedex
Unité de recherche INRIA Sophia-Antipolis, 2004 route des Lucioles, BP 93, 06902 SOPHIA-ANTIPOLIS Cedex

Éditeur
INRIA, Domaine de Voluceau, Rocquencourt, BP 105, 78153 LE CHESNAY Cedex (France)
ISSN 0249-6399