

A Reduced Basis Approach for Variational Problems with Stochastic Parameters: Application to Heat Conduction with Variable Robin Coefficient

Sébastien Boyaval, Claude Le Bris, Yvon Maday, Ngoc Cuong Nguyen,
Anthony Patera

► **To cite this version:**

Sébastien Boyaval, Claude Le Bris, Yvon Maday, Ngoc Cuong Nguyen, Anthony Patera. A Reduced Basis Approach for Variational Problems with Stochastic Parameters: Application to Heat Conduction with Variable Robin Coefficient. [Research Report] RR-6617, INRIA. 2008, pp.50. inria-00311463

HAL Id: inria-00311463

<https://hal.inria.fr/inria-00311463>

Submitted on 18 Aug 2008

HAL is a multi-disciplinary open access archive for the deposit and dissemination of scientific research documents, whether they are published or not. The documents may come from teaching and research institutions in France or abroad, or from public or private research centers.

L'archive ouverte pluridisciplinaire **HAL**, est destinée au dépôt et à la diffusion de documents scientifiques de niveau recherche, publiés ou non, émanant des établissements d'enseignement et de recherche français ou étrangers, des laboratoires publics ou privés.

***A Reduced Basis Approach for Variational Problems
with Stochastic Parameters:
Application to Heat Conduction with Variable Robin
Coefficient***

Sébastien Boyaval^{a,*}, Claude Le Bris^a, Yvon Maday^b, Ngoc Cuong Nguyen^c and Anthony T. Patera^c

^aCERMICS, Ecole Nationale des Ponts et Chaussées (ParisTech/Université Paris-Est), 77455 Marne-la-Vallée, France
and

MICMAC team-project, INRIA, Rocquencourt, 78153 Le Chesnay, France

^bUPMC Univ Paris 06, UMR 7598, Laboratoire Jacques-Louis Lions, F-75005, Paris, France
and

Division of Applied Mathematics, Brown University, Providence, RI 02912 USA

^cMassachusetts Institute of Technology, Dept. of Mechanical Engineering, Cambridge, MA 02139 USA

N° 6617

Août, 2008
Thème NUM



***rapport
de recherche***

A Reduced Basis Approach for Variational Problems with Stochastic Parameters: Application to Heat Conduction with Variable Robin Coefficient

Sébastien Boyaval^{a,*}, Claude Le Bris^a, Yvon Maday^b, Ngoc Cuong Nguyen^c and Anthony T. Patera^c

^aCERMICS, Ecole Nationale des Ponts et Chaussées (ParisTech/Université Paris-Est), 77455 Marne-la-Vallée, France

and

MICMAC team-project, INRIA, Rocquencourt, 78153 Le Chesnay, France

^bUPMC Univ Paris 06, UMR 7598, Laboratoire Jacques-Louis Lions, F-75005, Paris, France

and

Division of Applied Mathematics, Brown University, Providence, RI 02912 USA

^cMassachusetts Institute of Technology, Dept. of Mechanical Engineering, Cambridge, MA 02139 USA

Thème NUM — Systèmes numériques
Projet MICMAC

Rapport de recherche n° 6617 — Août, 2008 — 47 pages

Abstract: In this work, a Reduced Basis (RB) approach is used to solve a large number of Boundary Value Problems (BVPs) parametrized by a stochastic input — expressed as a Karhunen-Loève expansion — in order to compute outputs that are smooth functionals of the random solution fields. The RB method proposed here for variational problems parametrized by stochastic coefficients bears many similarities to the RB approach developed previously for deterministic systems. However, the stochastic framework requires the development of new *a posteriori* estimates for “statistical” outputs — such as the first two moments of integrals of the random solution fields; these error bounds, in turn, permit efficient sampling of the input stochastic parameters and fast reliable computation of the outputs in particular in the many-query context.

Key-words: Stochastic Partial Differential Equations; Karhunen-Loève; Monte Carlo; Parameterized Partial Differential Equations; Order Reduction Methods; Reduced Basis Method; *A posteriori* estimation

**Approche par bases réduites de problèmes variationnels
avec paramètres stochastiques:
application à la conduction de la chaleur avec coefficient
de Robin variable.**

Résumé : Dans ce travail, on utilise une approche Bases réduites (RB) pour résoudre un grand nombre de Problèmes aux bords (BVPs) paramétrés par une donnée d'entrée stochastique — exprimée comme un développement de Karhunen-Loève — en vue de calculer des données de sortie qui sont régulières en le champ aléatoire solution. La méthode RB proposée ici pour des problèmes variationnels paramétrés par des coefficients stochastiques est très similaire à l'approche RB développée antérieurement pour des problèmes déterministes. Cependant, le cadre stochastique requiert le développement de nouveaux estimateurs *a posteriori* pour des données de sortie “statistiques” — par exemple les deux premiers moments de fonctionnelles intégrales du champ aléatoire solution; ces bornes d'erreurs, en retour, permettent un échantillonnage efficace des paramètres d'entrée stochastiques et un calcul rapide et fiable des données de sortie, en particulier quand le calcul des données de sortie est réitéré pour de nombreuses valeurs des paramètres.

Mots-clés : Equations aux dérivées partielles stochastiques ; Karhunen-Loève ; Monte Carlo ; Equations aux dérivées partielles paramétriques ; Méthodes de réduction d'ordre ; Méthode de bases réduites ; Estimation *a posteriori*

1 Introduction

1.1 Overview

Let $U(x, \omega)$ be a random field solution to a BVP involving a Stochastic Partial Differential Equation (SPDE). For instance, we take $U(\cdot, \omega)$ as solution to a Partial Differential Equation (PDE) in a physical domain \mathcal{D}

$$-\operatorname{div}(\mathbf{a}(x)\nabla U(x, \omega)) = 0 ,$$

supplied with a stochastic Robin Boundary Condition (BC) on $\partial\mathcal{D}$ parametrized by a random input field $\operatorname{Bi}(x, \omega)$

$$\mathbf{n}(x)^T \mathbf{a}(x)\nabla U(x, \omega) + \operatorname{Bi}(x, \omega) U(x, \omega) = g(x) ;$$

here the random field $\operatorname{Bi}(x, \omega)$ (Biot number [17]) is non-zero (non-degenerate positive) on some subset $\Gamma_B \subset \partial\mathcal{D}$ of the boundary. Variations in the probability space $(\Omega, \mathcal{F}, \mathbf{P})$ are denoted by the variable ω , and variations in the spatial domain \mathcal{D} are denoted by x .

We consider the rapid and reliable computation of statistical outputs associated with $U(x, \omega)$ such as the expected value $\mathbf{E}_{\mathbf{P}}(S(\omega))$ and the variance $\mathbf{Var}_{\mathbf{P}}(S(\omega))$ of a random variable $S(\omega) = \mathcal{E}(U(\cdot, \omega))$ given by a linear (scalar) functional \mathcal{E} of the trace of $U(\cdot, \omega)$ on $\Gamma_R \subset \partial\mathcal{D}$ (where $\Gamma_R \cap \Gamma_B = \emptyset$)

$$\mathcal{E}(U(\cdot, \omega)) = \int_{\Gamma_R} U(\cdot, \omega) .$$

One possible strategy is to evaluate the statistical outputs as Monte-Carlo (MC) sums for (many) realizations $S(\omega_m)$, $1 \leq m \leq M$, of the random variable $S(\omega)$,

$$E_M[S] = \frac{1}{M} \sum_{m=1}^M S(\omega_m), \quad V_M[S] = \frac{1}{M-1} \sum_{m=1}^M (E_M[S] - S(\omega_m))^2 .$$

But M can be very large, and hence these MC evaluations can be very demanding (for each ω_m , one must solve a BVP PDE in \mathcal{D}). Furthermore, in actual practice, and as developed subsequently in this paper, we are often interested in evaluating our statistical outputs for different values of deterministic parameters, say ϱ — which even further increases the computational challenge. For this reason we develop a reduced basis (RB) approach: to decrease the computational cost of the many Finite Element (FE) approximations, $U_{\mathcal{N}}(x, \omega_m) \approx U(x, \omega_m)$, $1 \leq m \leq M$, required in the Monte-Carlo sums.

Toward this goal, we first rewrite the parametrization of the BVP using a Karhunen-Loève (KL) expansion of the random input field $\operatorname{Bi}(x, \omega)$

$$\operatorname{Bi}(x, \omega) = \mathbf{E}_{\mathbf{P}}(\operatorname{Bi})(x) + \tilde{\Upsilon} \sum_{k=1}^{\mathcal{K}} \sqrt{\lambda_k} \Phi_k(x) Z_k(\omega) ,$$

*Corresponding author: boyaval@cermics.enpc.fr (S. Boyaval).

where \mathcal{K} is the rank (possibly infinite) of the covariance operator for $\text{Bi}(x, \omega)$ with eigenpairs $(\tilde{\Upsilon}^2 \lambda_k, \Phi_k)_{1 \leq k \leq \mathcal{K}}$, the $(Z_k)_{1 \leq k \leq \mathcal{K}}$ are mutually uncorrelated random variables in $L^2_{\mathbb{P}}(\Omega)$, and $\tilde{\Upsilon}$ is a positive amplitude parameter. In Section 2 we recall the mathematical details associated with the KL expansion as well as some basic facts about SPDEs and the different formulations for BVPs involving stochastic coefficients. We next define a solution $U_K(x, \omega)$ to the BVP in which, instead of $\text{Bi}(x, \omega)$, a truncated version $\text{Bi}_K(x, \omega)$ of the KL expansion (up to order $K \leq \mathcal{K}$) is used in the Robin BCs. Then, for each realization ω we map $U_K(x, \omega)$ from the solution $u_K(x; y^K)$ to the BVP

$$\begin{cases} -\text{div}(\mathbf{a}(x)\nabla u_K(x; y^K)) = 0 & \text{in } \mathcal{D}, \\ \mathbf{n}(x)^T \mathbf{a}(x)\nabla u_K(x; y^K) + \text{Bi}_K(x, y^K)u_K(x, y^K) = g(x) & \text{in } \partial\mathcal{D}, \end{cases} \quad (1)$$

with K deterministic coefficients (y_1, \dots, y_K) denoted by the multi-dimensional parameter y^K . Here y^K shall reside in an appropriate domain Λ_K^y ; in particular, the (y_1, \dots, y_K) shall assume the values of $\tilde{\Upsilon}\sqrt{\lambda_k}(Z_k(\omega))_{1 \leq k \leq K}$.

The statistical outputs obtained after truncation of the KL expansion,

$$E_M[S_K] = \frac{1}{M} \sum_{m=1}^M S_K(\omega_m), \quad V_M[S_K] = \frac{1}{M-1} \sum_{m=1}^M (E_M[S_K] - S_K(\omega_m))^2,$$

can then be obtained as

$$E_M[s_K] = \frac{1}{M} \sum_{m=1}^M s_K(y^K(\omega_m)), \quad V_M[s_K] = \frac{1}{M-1} \sum_{m=1}^M (E_M[s_K] - s_K(y^K(\omega_m)))^2, \quad (2)$$

in which $s_K(y^K) = \mathcal{E}(u_K(\cdot; y^K))$, and the distribution of the random variable $y^K(\omega)$ is identified with the joint distribution of $\tilde{\Upsilon}\sqrt{\lambda_k}(Z_k(\omega), 1 \leq k \leq K)$. Clearly, the error in these outputs due to truncation of the KL expansion must be assessed; we discuss this issue further below. (We must also ensure that M is large enough; we address this question in the context of our numerical results.)

In Section 3, we develop a reduced basis (RB) approach [1, 11, 27, 28] for the parametrized (deterministic) BVP (1) and outputs (2) for the case in which the random variables $y_k(\omega)$, $1 \leq k \leq K$ ($\leq \mathcal{K}$), are bounded (uniformly if $\mathcal{K} = +\infty$) such that the KL expansion is positive for any truncation order $K \in \mathbb{N}$ and converges absolutely a.e. in $\partial\mathcal{D}$ when $\mathcal{K} = +\infty$; the latter ensures well-posedness of the BVPs obtained after truncation at any order $1 \leq K \leq \mathcal{K}$. We shall present numerical results for a random input field Bi whose spatial autocorrelation operator is Gaussian such that the KL spectrum decays rapidly.

In particular, we shall show that our RB approach significantly reduces the computational cost of the MC evaluations with no sensible loss of accuracy compared to a direct Finite Element (FE) approach: for instance, the RB computational time with truncated KL expansions of order $K \leq 20$ is reduced by a factor of $\frac{1}{45}$ relative to the

FE result, while the (relative) approximation error in the expectation — due to both RB and KL truncation — is controlled *and* certified to (say for $K = 20$) 0.1%. Our RB approach thus also straightforwardly permits rapid exploration of the dependence of the outputs $E_M[s_K](\varrho)$ and $V_M[s_K](\varrho)$ on variations in additional deterministic parameters ϱ (other than y^K) entering the problem. (In the limit of many evaluations at different ϱ the computational savings relative to FE are, for our example, $O(200)$.)

1.2 Relation to Prior Work

The computation of BVPs involving SPDEs has been identified as a demanding task [3, 9, 23] for several years and many different numerical approaches have already been proposed. Several reduction techniques have already been employed for variational formulations on the high-dimensional tensor-product space $\mathcal{D} \times \Lambda_K^y$ — in particular sparse/adaptive methods [12, 34], stochastic RB Krylov methods [24, 31], and collocation approaches [2, 26] — with a view to reduce the computationally (very) expensive *spectral Galerkin* discretizations [14] based on a (generalized) Polynomial Chaos (PC) expansion of the solution [38, 39] (that is, linear combinations of stochastic basis vectors that are polynomials of independent random variables). These reduction techniques have shown good performance. However, the sparse/adaptive methods require substantial implementation efforts, the stochastic RB Krylov method does not yet provide rigorous *a posteriori* analysis to control the output approximation error, and the collocation method invokes numerous (expensive) FE solutions. The RB approach described here — albeit for a limited class of problems — focuses on simple implementation, rigorous *a posteriori* error bounds, and parsimonious appeal to the FE “truth.”

Compared with numerical approaches developed previously for SPDEs, the main features of our RB approach are the following:

- (a) the outputs are computed through Monte-Carlo (MC) evaluations of the random variable $s_K(y^K(\omega))$, and not through quadrature or collocation formulas for the deterministic function $s_K(y^K)$ (though see below for a discussion of generalizations);
- (b) a large number of variational approximations for the solutions $u_K(x; y^K)$ to a BVP defined over the (relatively) low-dimensional physical space \mathcal{D} and parametrized by y^K must be computed for each MC sum (for each ϱ) — as opposed to Galerkin variational methods in which $u_K(x; y^K)$ is discretized on the high-dimensional tensor-product space for (x, y^K) such that only one, very expensive, solution is required (for each ϱ);
- (c) the original stochastic BVP is mapped for almost every outcome $\omega \in \Omega$ from a deterministic BVP the variational formulation of which must have an *affine* parametrization¹ (*affine* in the sense that the weak form can be expressed as a sum of products of parameter-dependent functions and parameter-independent

¹Non-affine (but piecewise smooth) parametrizations can also be treated by the so-called *magic points* to “empirically” interpolate the coefficients entering the variational formulation [4, 15].

forms) — as typically provided by a KL expansion of the random input field which decouples the dependence on the probability and physical spaces;

- (d) the “deterministic” RB approach [21, 29, 30] is then applied to the deterministic BVP to yield — based on a many-query Offline-Online computational strategy — greatly reduced computational cost at little loss in accuracy or, thanks to rigorous *a posteriori* bounds, certainty.

Of course our approach also bears many similarities to earlier proposals, most notably reliance on the KL expansion of the random input field and on smoothness with respect to the associated parameter y^K .

In fact in some cases, in particular the collocation approaches described in [2, 26], the RB method proposed in this paper can be viewed as an *accelerator*. The collocation approaches apply quadrature formulas for the computation of the outputs $\mathbf{E}_{\mathbf{P}}(s_K(y^K(\omega)))$ and $\mathbf{Var}_{\mathbf{P}}(s_K(y^K(\omega)))$ to decouple variational formulations for $u_K(x; y^K)$ in the high-dimensional tensor-product space $\mathcal{D} \times \Lambda_K^y$ into many variational formulations in the lower-dimensional space \mathcal{D} parametrized by $y^K \in \Lambda_K^y$. Clearly, we may replace s_K by a (certified) RB approximation to further reduce the computational effort. Equivalently, we may replace the MC sums of our current approach with the quadrature rules developed in [2, 26]. Future work will investigate this promising opportunity.

In closing, we note that some important modifications to the deterministic RB framework are required in order to treat SPDEs. First, we must develop error bounds for outputs that are sums over many parameter realizations. Second, we must develop an additional *a posteriori* error bound contribution due to the truncation of the KL expansion of the random input field; these error bounds are crucial not only to certainty but also to control of the computational cost. As regards the latter, we note that SPDEs result in typically many ($> K$) deterministic parameters (y^K, ϱ): rapid convergence — that does not break but at least moderates the curse of dimensionality — relies heavily not only on the smoothness of $u_K(x; y^K)$ with respect to y^K , but also on the limited range of the y_k when $k \gg 1$; the latter, in turn, derives from the (assumed) smoothness of the autocorrelation (rapid decay of the λ_k). It is imperative to choose K as small as possible.

2 Variational Formulation of a Boundary Value Problem with Stochastic Parameters

2.1 Stochastic Partial Differential Equations

The modelling of multiscale problems in science and engineering is often cast into the following framework. At the macroscopic scale at which important quantities must be computed, a (possibly multi-dimensional) field variable U is assumed to satisfy a PDE on a physical domain $\mathcal{D} \subset \mathbb{R}^d$ ($d = 2, 3$, or 4 for common applications)

$$A(\omega)U(\omega) = f(\omega) \text{ in } \mathcal{D} , \quad (3)$$

supplied with Boundary Conditions (BC) on the (sufficiently smooth) boundary $\partial\mathcal{D}$,

$$B(\omega)U(\omega) = g(\omega) \text{ in } \partial\mathcal{D} ; \quad (4)$$

here the differential operators $A(\omega)$, $B(\omega)$ and the source terms $f(\omega)$, $g(\omega)$ are parametrized at each point of the physical domain by a variable ω describing the state of some generalized local microstructure. We shall not discuss other possible formulations for multiscale problems, such as integral equations; furthermore, the formulation above will be assumed well-posed in the sense of Hadamard for the case in which $A(\omega)$, $B(\omega)$, $f(\omega)$, and $g(\omega)$ vary with the microstructure ω (extensions of this work to distributions, that is, generalized functions of ω , are not straightforward).

To model the ‘‘fluctuations’’ of the underlying microstructure, whose impact on the macroscopic quantities of interest is to be evaluated, we can assume — without invoking detailed information about the microstructure — that the input is random, introducing an abstract probability space Ω to model the fluctuations ($\omega \in \Omega$). The outputs of such models are then also random by nature. The equations (3),(4) are then generally called Stochastic PDEs (SPDEs). SPDEs are useful when one cannot, or does not want to, describe precisely the microstructure. Examples include uncertainty quantification for structures in civil engineering [8, 33], for complex flows in fluid dynamics [22], or for multiphase flows in porous media [13].²

2.2 Problem Statement: Stochastic Robin Boundary Condition

The RB method has been introduced earlier for the multi-query evaluation of outputs for various parametrized variational problems [21, 29, 30] in a deterministic framework (deterministic PDE and BC). In this work, we shall choose only one (simple) example to illustrate the stochastic case; however, it should be clear that the approach admits a general abstraction applicable to a wide class of problems.³ We now pose our particular problem.

Let $(\Omega, \mathcal{F}, \mathbf{P})$ be a complete probability space where Ω is the set of outcomes ω , \mathcal{F} is the σ -algebra of events among all subsets of Ω , and \mathbf{P} is a probability measure (notice that this definition itself is often a practical issue for the modeller). Let the physical domain \mathcal{D} be an open, bounded, connected subset of \mathbb{R}^2 ($d = 2$) with Lipschitz polyhedral boundary, which we classically equip with the usual Borel σ -algebra and the Lebesgue measure. We recall that random fields are collections of scalar random variables that can be mapped to (some part of) the physical domain (\mathcal{D} or $\partial\mathcal{D}$ for

²We note that by choosing the microscopic fluctuations as stationary ergodic random fields, the numerical treatment of averaged outputs for SPDEs also applies to many situations considered in stochastic homogenization theory [5, 18], in which a powerful and elegant analysis of (weak) convergences allows one to reduce the modelling of complex multiscale problems to a more tractable set of sub-problems. Note that the RB approach has been applied to efficient numerical treatment of multiscale problems with locally periodic fluctuations within the context of deterministic homogenization theory [6].

³We shall limit attention to those simple SPDEs which are not generalizations of Stochastic Differential Equations (SDEs) to multi-dimensional derivatives — where outcomes of the random input are distributions (generalized functions). Such interesting cases will be the subject of future work.

instance), that is, functions defined on (some part of) the physical space that take values in some functional space of \mathbf{P} -measurable functions on the probability space Ω (random variables), say $L^2_{\mathbf{P}}(\Omega)$, the space of square-integrable functions on Ω .

Let us introduce some further notations:

- $L^2(\mathcal{D})$ the Hilbert space of Lebesgue square integrable functions in \mathcal{D} ;
- $H^1(\mathcal{D})$ the usual Sobolev space (with Hilbert structure) of functions in $L^2(\mathcal{D})$ that have gradient in $[L^2(\mathcal{D})]^2$, imbued with the usual Hilbert norm $\|\cdot\|_{1,\mathcal{D}}$;
- $L^2(\partial\mathcal{D})$ the Hilbert space of the Lebesgue square integrable functions in the manifold $\partial\mathcal{D}$ equipped with its Borel σ -algebra, imbued with the Hilbert norm $\|\cdot\|_{0,\partial\mathcal{D}}$;
- $L^\infty(\partial\mathcal{D})$ the Banach space of essentially bounded functions on the manifold $\partial\mathcal{D}$, imbued with its usual norm $\|\cdot\|_{\infty,\partial\mathcal{D}}$.

We also recall that functions $v \in H^1(\mathcal{D})$ have a trace $v|_{\partial\mathcal{D}} \in L^2(\partial\mathcal{D})$ that satisfies

$$\|v|_{\partial\mathcal{D}}\|_{0,\partial\mathcal{D}} \leq \tilde{\gamma}\|v\|_{1,\mathcal{D}} , \quad (5)$$

where $\tilde{\gamma} \equiv \tilde{\gamma}(\mathcal{D})$ is a constant positive real number that depends only on \mathcal{D} .

In the following, we shall deal with SPDEs in which only the differential operator $B(\omega)$ is parametrized by a random input field, in particular $\text{Bi}(x, \omega): \partial\mathcal{D} \times \Omega \rightarrow \mathbb{R}$: we identify in (3),(4)

$$\begin{aligned} A(x, \omega) &= -\text{div}(\mathbf{a}(x)\nabla\cdot), & f(x, \omega) &= 0, & \forall x \in \mathcal{D} , \\ B(x, \omega) &= \mathbf{n}^T(x) \mathbf{a}(x) \nabla\cdot + \text{Bi}(x, \omega)\cdot, & g(x, \omega) &= g(x), & \forall x \in \partial\mathcal{D} , \end{aligned}$$

where $\mathbf{n}(x)$ is the outward unit normal at position x in $\partial\mathcal{D}$ and T denotes the transpose. The solution $U(x, \omega)$ is then a random field with $(x, \omega) \in \mathcal{D} \times \Omega$. The case in which the other terms are also stochastic is a straightforward extension, provided the problem (3),(4) remains well-posed in the sense of Hadamard with respect to the variations $\omega \in \Omega$. Note that the divergence div and gradient ∇ operators imply differentiations with respect to the physical variable x only, and not with respect to the probability variable ω .

For almost every $\omega \in \Omega$, the scalar random field $U(x, \omega)$ with $x \in \mathcal{D}$ is thus defined as the solution to the following Robin BVP (presumed well-posed): $U(x, \omega)$ satisfies the Laplace equation in \mathcal{D} ,

$$-\text{div}(\mathbf{a}(x) \nabla U(x, \omega)) = 0 , \quad (6)$$

supplied with a stochastic Robin BC on the smooth manifold $\partial\mathcal{D}$ (Lipschitz polyhedral with finite one-dimensional measure),

$$\mathbf{n}(x)^T \mathbf{a}(x) \nabla U(x, \omega) + \text{Bi}(x, \omega)U(x, \omega) = g(x) . \quad (7)$$

The diffusion matrix \mathbf{a} is deterministic (strictly positive) and isotropic though non-necessarily constant for all $x \in \mathcal{D}$,

$$\mathbf{a}(x) = \begin{bmatrix} \kappa(x) & 0 \\ 0 & \kappa(x) \end{bmatrix}, \quad \forall x \in \mathcal{D} .$$

We shall assume $0 < \kappa_{\min} \leq \kappa(x) \leq \kappa_{\max} < +\infty$ for well-posedness. The boundary $\partial\mathcal{D}$ is divided into three non-overlapping open subsets

$$\partial\mathcal{D} \subset (\overline{\Gamma_N} \cup \overline{\Gamma_R} \cup \overline{\Gamma_B}) .$$

The boundary (Root) source term g is taken as deterministic and non-zero (and constant) on Γ_R only,

$$g(x) = 1_{\Gamma_R}, \quad \forall x \in \partial\mathcal{D} ,$$

while the *Biot number* Bi is taken as a positive random field non-degenerate on Γ_B only,

$$\text{Bi}(x, \omega) = \text{Bi}(x, \omega) 1_{\Gamma_B} .$$

Note that on Γ_N (7) thus reduces to homogeneous Neumann conditions.

The physical interpretation is simple: if T_0 is the constant temperature of the ambient medium, $T_0 + u$ is the steady-state temperature field in a domain \mathcal{D} (comprised of an isotropic material of thermal conductivity κ) subject to zero heat flux on boundary Γ_N (either by contact with a thermal insulator or for reasons of symmetry), constant flux at boundary Γ_R (contact with a heat source), and a random heat transfer coefficient Bi at boundary Γ_B (contact with a convective fluid medium). Note that the Biot number Bi is a fashion for decoupling the solid conduction problem from the exterior fluid convection problem: it is at best an engineering approximation, and at worst a rough average — often not reflecting the environmental details; it thus makes sense to model the unknown Bi variations as a random (but typically rather smooth) field in order to understand the sensitivity of output quantities to heat transfer coefficient uncertainties.

For the numerical application of Section 3, we shall consider the steady heat conduction problem (6),(7) inside a T-shaped heat sink \mathcal{D} as shown in Figure 1. The heat sink comprises a 2×1 rectangular substrate (spreader) $\mathcal{D}_2 \equiv (-1, 1) \times (0, 1)$ on top of which is situated a 0.5×4 thermal fin $\mathcal{D}_1 \equiv (-0.25, 0.25) \times (1, 5)$. (In effect, all lengths will be nondimensionalized relative to the side-length of the substrate.) We shall take a (normalized) piecewise constant diffusion coefficient

$$\kappa(x) = 1_{\mathcal{D}_1} + \kappa 1_{\mathcal{D}_2} ,$$

where $1_{\mathcal{D}_i}$ is the characteristic function of domain \mathcal{D}_i ($i = 1, 2$). On Γ_B , the two sides of the fin, we shall impose zero sink temperature ($T_0 = 0$) and a *stochastic* convection/Robin BC with a non-zero Biot number Bi built from statistical data (mean value, spatial autocorrelation, pointwise variance); on Γ_R , the root, we impose unit flux $g(x) = 1$; and on Γ_N , we impose zero flux.

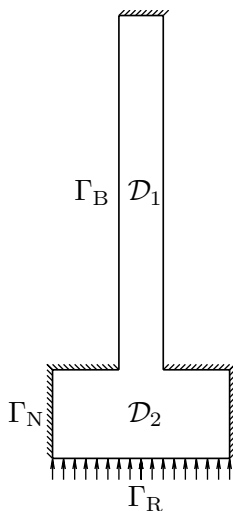

Figure 1: Geometry of the heat sink: a spreader \mathcal{D}_2 and a fin \mathcal{D}_1 .

The outputs of interest will be the first two moments of a (scalar) linear functional \mathcal{E} of the random solution fields U . Recall that we define \mathcal{E} as the integrated trace $U|_{\Gamma_R}(x, \omega)$ of the random field solution $U(x, \omega)$ on the edge Γ_R of the domain \mathcal{D} (corresponding to the location of the heat source — the point at which we wish to control the temperature),

$$S(\omega) := \mathcal{E}(U(\cdot, \omega)) = \int_{\Gamma_R} U|_{\Gamma_R}(\cdot, \omega), \quad \forall \omega \in \Omega .$$

Hence, if the random variable $S(\omega)$ is sufficiently regular (for instance in $L^2_{\mathbf{P}}(\Omega)$), we are interested in approximations of the expected value with respect to the probability measure \mathbf{P} ,

$$\mathbf{E}_{\mathbf{P}}(S) := \int_{\Omega} S(\omega) d\mathbf{P}(\omega) , \quad (8)$$

and in the variance,

$$\mathbf{Var}_{\mathbf{P}}(S) := \int_{\Omega} S(\omega)^2 d\mathbf{P}(\omega) - \mathbf{E}_{\mathbf{P}}(S)^2 . \quad (9)$$

Remark 2.1 (Outputs). *It is possible to consider other (and multiple) outputs within the RB approach. Essentially these outputs should be empirical estimations for functionals of $U(\cdot, \omega)$ that are continuous with respect to some $L^p_{\mathbf{P}}(\Omega, H^1(\mathcal{D}))$ topology ($1 \leq p \leq +\infty$). Note that interesting cases such as $L^\infty_{\mathbf{P}}(\Omega, H^1(\mathcal{D}))$ are covered by this first RB approach, for example statistical outputs such as pointwise values of a cumulative distribution function*

$$\mathbf{P} \{ \omega \in \Omega | \mathcal{E}(U(\cdot, \omega)) \leq \mathcal{E}_0 \}$$

for some finite numbers $\mathcal{E}_0 \in \mathbb{R}$.

In the numerical application of Section 3, the statistical outputs (8) and (9) (expected value and variance of the integrated temperature at the bottom surface of the heat sink, Γ_R) will be explored in a multi-query context (of design optimization for instance) as functions of the deterministic parameter $\varrho = (\kappa, \overline{\text{Bi}})$ in the range $\Lambda^\varrho := [0.1, 10] \times [0.1, 1]$ with

$$\overline{\text{Bi}} := \frac{1}{|\Gamma_B|} \int_{\Gamma_B} \mathbf{E}_{\mathbf{P}}(\text{Bi}) .$$

The detailed stochastic description of $\text{Bi}(x, \omega)$ will be described in Section 2.4.

2.3 Different Discretization Formulations

Much attention has been devoted recently to the development and the numerical analysis of various numerical approaches for BVPs involving SPDEs [2, 3, 9, 12, 14, 19, 23, 26, 31, 35, 36, 37, 39]. Our RB approach specifically aims at reducing the number of computations in many of the previously developed frameworks without any loss in precision by (i) splitting the computations into *Offline* and *Online* steps, and (ii) maintaining accuracy control through *a posteriori* error estimation of the outputs. The RB approach applies to those formulations that are variational with respect to variables in the physical space \mathcal{D} , which we denote \mathcal{D} -weak formulations, and can be combined with different treatments of the probabilistic dependence. The latter fall into two main categories: the Ω -strong/ \mathcal{D} -weak formulations; and the Ω -weak/ \mathcal{D} -weak formulations.

We would like to underline the fact, already discussed in the introduction, that although we shall only deal with Ω -strong/ \mathcal{D} -weak formulations in the rest of this paper, our RB approach applies equally well to many Ω -weak/ \mathcal{D} -weak formulations in particular of the (Galerkin + quadrature =) collocation variety [2, 26]. The details of extensions to Ω -weak/ \mathcal{D} -weak formulations are left for a future paper in order to keep our presentation of the RB method as simple as possible. However, before entering into the details of the RB approach for Ω -strong/ \mathcal{D} -weak formulations, we shall briefly summarize the principles of each of the different formulations so as to make it clear how our RB approach would adapt to Ω -weak/ \mathcal{D} -weak formulations. (Both formulations have been studied extensively before, though typically by different authors; a few studies already compare both formulations [3, 23], but it may be interesting to reevaluate such comparisons between formulations from the viewpoint of our RB approach.)

2.3.1 Strong-Weak Formulations

The Ω -strong/ \mathcal{D} -weak formulations implicitly assume the \mathbf{P} -almost-sure (a.s.) existence of a weak solution $U(\omega)$ to the BVP (6),(7). For \mathbf{P} -almost-every (a.e.) $\omega \in \Omega$, $U(\omega) \in H^1(\mathcal{D})$ is a weak solution to (6),(7) if it satisfies

$$\int_{\mathcal{D}} \mathbf{a} \nabla U(\omega) \cdot \nabla v + \int_{\Gamma_B} \text{Bi}(\omega) U(\omega) v = \int_{\Gamma_R} v, \quad \forall v \in H^1(\mathcal{D}) . \quad (10)$$

If the Biot number satisfies $\text{Bi}(\omega) \in L^\infty(\partial\mathcal{D})$ \mathbf{P} -a.s. and is non-degenerate positive on the (non-negligible) subset Γ_B of $\partial\mathcal{D}$ (we assume $0 < b_{\min}(\omega) \leq \text{Bi}(\omega) \leq b_{\max}(\omega) < +\infty$

a.e. in Γ_B , \mathbf{P} -a.s.) then, by virtue of the Lax-Milgram theorem, there exists a unique (weak) solution $U(\omega) \in H^1(\mathcal{D})$ to (10). We can furthermore obtain the stability result

$$\|U(\omega)\|_{1,\mathcal{D}} \leq \frac{C_1(\mathcal{D})}{\min\{1, \kappa_{\min}, b_{\min}(\omega)\}} , \quad (11)$$

for a constant positive real number $C_1(\mathcal{D})$ that depends only on \mathcal{D} .

For such solutions $U(\omega) \in H^1(\mathcal{D})$, thanks to (5) and (11), the functional $S(\omega) = \mathcal{E}(U(\omega))$ then makes sense: the trace on the boundary part Γ_R with non-zero one-dimensional measure, which we write $U|_{\Gamma_R}(\omega)$, is well-defined. The outputs $\mathbf{E}_{\mathbf{P}}(S)$, $\mathbf{Var}_{\mathbf{P}}(S)$ in the Ω -strong/ \mathcal{D} -weak formulations can then be approximated by empirical Monte-Carlo estimations,

$$E_M[S] = \frac{1}{M} \sum_{m=1}^M S(\omega_m) , \quad (12)$$

$$V_M[S] = \frac{1}{M-1} \sum_{m=1}^M (S(\omega_m) - E_M[S])^2 , \quad (13)$$

where $\Xi_M^\omega = \{\omega_m; 1 \leq m \leq M\}$ is a collection of M independent identically distributed random numbers that can be mapped (for each outcome in Ω) to M independent copies of the random field $\text{Bi}(x, \omega)$. Indeed, since $\text{Bi}^{-1} \in L_{\mathbf{P}}^\infty(\Omega, L^\infty(\partial\mathcal{D})) \subset L_{\mathbf{P}}^2(\Omega, L^\infty(\partial\mathcal{D}))$ (where $\text{Bi}^{-1}(\omega)$ is well-defined \mathbf{P} -a.s.), we have $\|U(\omega)\|_{1,\mathcal{D}} \in L_{\mathbf{P}}^2(\Omega)$, and thus $S(\omega) \in L_{\mathbf{P}}^2(\Omega)$; and if $\{S(\omega_m), m = 1, \dots, M\}$ are M independent copies (with same law) of the random variable $S(\omega)$, we thus have

$$E_M[S] \xrightarrow[M \rightarrow +\infty]{\mathbf{P}\text{-a.s.}} \mathbf{E}_{\mathbf{P}}(S) , \quad (14)$$

$$V_M[S] \xrightarrow[M \rightarrow +\infty]{\mathbf{P}\text{-a.s.}} \mathbf{Var}_{\mathbf{P}}(S) , \quad (15)$$

by virtue of the Strong Law of Large Numbers (SLLN).

Hence a major advantage of the Ω -strong/ \mathcal{D} -weak formulations is to permit the direct application of classical computational procedures (in particular, FE) for the numerical approximation of deterministic BVPs such as (10) in their usual form, without any modification. Many (many ...) computations of such parametrized approximate solutions can then be combined — according to (the numerical simulation of) the law of the random field parameter $\text{Bi}(x, \omega)$ — to form the MC evaluations. Such formulations are thus very simple from the implementation viewpoint, presuming (as for all formulations) that we can readily simulate the law of $\text{Bi}(x_k, \omega)$ at those discrete (e.g., quadrature or nodal) points x_k in the physical domain \mathcal{D} required by the numerical approximation of (10) (see Section 2.4.1).

However, the convergence (in probability) of SLLN will be slow — the rate of convergence for $E_M[S]$ is governed by the ratio of the variance of S (roughly approximated by

$V_M[S]$ to \sqrt{M} by virtue of the Central Limit Theorem (CLT). This slow convergence is a strong limitation in the application of Ω -strong/ \mathcal{D} -weak formulations. Variance reduction techniques, such as Quasi-Monte-Carlo (QMC) methods based on low-discrepancy sequences of random numbers [35], have been developed to reduce the statistical error of the empirical estimations (12). And the RB approach itself brings new possibilities to addressing this slow convergence problem, not by directly reducing the number of necessary outcomes in the MC sums, but rather by improving the numerical treatment of many slow-varying outcomes.

In Section 3, we shall show how to apply our RB approach to the numerical approximation of Ω -strong/ \mathcal{D} -weak formulations by taking advantage of the parametrized character of the BVP. We first map outcomes of stochastic coefficients to deterministic value of the parameters; we then reduce the computational cost of numerical approximations of the BVP for many values of the parameter by splitting the computations into Offline-Online steps; finally, we introduce *a posteriori* error control on the accuracy of the RB-KL approximations (relative to very accurate approximations in high-dimensional discretization-probability space). (We do not consider here variance reduction strategies.)

2.3.2 Weak-Weak Formulations

The Ω -weak/ \mathcal{D} -weak formulations discretize a variational formulation of the original BVP on the full tensor-product space $\Omega \times \mathcal{D}$. The weak-weak formulations may thus require less regularity and can furthermore provide greatly improved convergence relative to SLLN (in fact, convergence is often improved only for small dimensions, where numerical approaches for this formulation are sufficiently simple).

In the weak-weak formulation, we seek a solution $U(\omega) \in L^2_{\mathbf{P}}(\Omega, H^1(\mathcal{D}))$ to the BVP (6),(7) such that

$$\begin{aligned}
 \int_{\Omega} d\mathbf{P}(\omega) \int_{\mathcal{D}} \mathbf{a} \nabla U(\omega) \cdot \nabla v + \int_{\Omega} d\mathbf{P}(\omega) \int_{\Gamma_B} \text{Bi}(\omega) U(\omega) v \\
 = \int_{\Omega} d\mathbf{P}(\omega) \int_{\Gamma_R} v, \quad \forall v \in L^2_{\mathbf{P}}(\Omega, H^1(\mathcal{D})) . \quad (16)
 \end{aligned}$$

Again, such a weak solution exists when the Biot number satisfies $\text{Bi}(\omega) \in L^\infty(\partial\mathcal{D})$ \mathbf{P} -a.s. and is strictly positive on the subset Γ_B of $\partial\mathcal{D}$ with non-negligible 1-measure (assuming $0 < b_{\min}(\omega) \leq \text{Bi}(\omega) \leq b_{\max}(\omega) < +\infty$ a.e. in Γ_B , \mathbf{P} -a.s.), and again, it is possible to give a meaning to $U(\omega)$, $S(\omega)$, and the outputs $\mathbf{E}_{\mathbf{P}}(S)$, $\mathbf{Var}_{\mathbf{P}}(S)$. The computations of $S(\omega)$, $\mathbf{E}_{\mathbf{P}}(S)$, and $\mathbf{Var}_{\mathbf{P}}(S)$ are effected by quadrature (or collocation) formulas in $\Omega \times \mathcal{D}$ once discrete approximations for $U(\omega)$ have been computed; the latter are typically based on Galerkin projection over tensor-product approximation subspaces of the Hilbert space $L^2_{\mathbf{P}}(\Omega, H^1(\mathcal{D}))$ defined over the (high-dimensional) domain $\Omega \times \mathcal{D}$.

For instance, the seminal work [14] used so-called stochastic (or spectral) Galerkin methods, in which $L^2_{\mathbf{P}}(\Omega, H^1(\mathcal{D}))$ is discretized by tensor products of classical discrete

approximations for the variational formulation of a BVP in $H^1(\mathcal{D})$ (such as FE) multiplied by orthogonal polynomials $\{H_n, n \in \mathbb{N}\}$ of independent identically distributed (i.i.d.) random variables $\{\xi_r(\omega), r \in \mathbb{N}\}$,

$$H_0, \quad H_1(\xi_r(\omega)), \quad H_2(\xi_{r_1}(\omega), \xi_{r_2}(\omega)), \dots, \quad r, r_1, r_2 \in \mathbb{N}, \quad r_1 \geq r_2 \geq 0, \dots .$$

In the original Polynomial Chaos (PC) expansion of Wiener [38] for $L^2_{\mathbf{P}}(\Omega)$, the H_n are Hermite polynomials and the variates ξ_r are Gaussian; this expansion has then been generalized to other couples of polynomials and probability distributions [39].

Truncating the PC expansions at order $R = (R_1, \dots, R_p)$ (where only $p > 0$ variates are retained and R_i is the maximal degree of the variable ξ_i in the polynomials — usually chosen consistently with discretizations of the random input field $\text{Bi}(x, \omega)$ through KL expansions), the variational formulation (16) is then mapped to another variational formulation on the (very high) $(d + p)$ -dimensional domain in which (x, ξ_1, \dots, ξ_p) take its values; the discretization level in each direction of the tensor-product Galerkin approximations can then be tailored to achieve rapid convergence with respect to the number of degrees of freedom (d.o.f.). (In fact, *a posteriori* error indicators and reduced spaces — though quite different from the error bounds and reduced basis spaces presented in the present paper — can serve to identify efficient truncations [37].) A major limitation of such spectral Galerkin methods is the high-dimensionality of the approximation spaces for (truncated) PC expansions, which necessitates complicated (though certainly often efficient) numerical strategies in order to maintain sparsity on the discretization grid [3, 12, 23, 34, 37].

There are many approaches to the *curse of dimensionality*. We shall elaborate here on the two methods most closely related to our RB approach: collocation techniques and the Stochastic Reduced Basis Method (SRBM). Pseudospectral Galerkin methods [2, 3, 9] based on particular orthogonal polynomial spaces and particular (perhaps sparse [26]) collocation points (ξ_1, \dots, ξ_p) adapted to these polynomials, decouple the BVP (16) into many BVPs over \mathcal{D} only — akin to (10). (There are some limitations on the random input field, necessarily treated as a truncated KL expansion.) The latter pseudospectral-FE method then requires multiple (parallelizable) computations of approximate solutions to a BVP over \mathcal{D} parametrized by (ξ_1, \dots, ξ_p) . The RB method developed in the current paper (for Ω -strong/ \mathcal{D} -weak formulations) can in fact be directly applied to the parametrized BVPs of the collocation approach (not surprising given that collocation admits a strong interpretation); we provide details of this synergy in a future paper.

The SRBM [24, 31] — the first application of RB ideas within the SPDE context — is in some ways similar to our RB approach (in particular in the exploitation of the KL expansion and associated $\omega - x$ separability) — and in some ways different (in particular related to approximation space and *a posteriori* error estimation). The SRBM directly tackles a (sufficiently fine) discretized version of the weak-weak formulation and then approximates the solution to this discrete problem in a “reduced” vector space. In the most general form the SRBM has been applied to SPDEs linear in the random field solution $U(x, \xi_1, \dots, \xi_p)$ with stochastic coefficients expanded as combinations of p independent Gaussian random variables (ξ_1, \dots, ξ_p) [31] (using a truncated KL expansion

with p Gaussian random variables, perhaps combined with a PC expansion of order $R = (D_1, \dots, D_1)$ that is of maximal degree D_1 for each variable ξ_i , $1 \leq i \leq p$).

The field variable $U(x, \xi_1, \dots, \xi_p)$ is first approximated as a product of functions of the physical variable $x \in \Omega$ (in a discrete \mathcal{N} -dimensional FE space, for instance) and low-order polynomials $H_k(\xi_1, \dots, \xi_p)$, $1 \leq k \leq P_2$, of a PC expansion in the probabilistic variables (ξ_1, \dots, ξ_p) associated with the stochastic coefficients. More precisely, the maximal degree D_2 of each variable ξ_i , $1 \leq i \leq p$, in the PC expansion of the solution is chosen such that the dimension $P_2 + 1 = \binom{p+D_2}{p} + 1$ of the resulting vector space remains reasonably small, that is $D_2 \leq D_1 \times (d - 1)$ (the highest possible degree of the solution is $D_1 \times (d - 1)$ by Kramer's formula); this order reduction, termed a *pseudo-spectral* approach [10], exploits the orthogonality of the PC basis (note this orthogonality property suggests $D_2 \geq \sqrt{D_1}$), but also introduces an approximation error in the solution. Denoting by $P_1 + 1 = \binom{p+D_1}{p} + 1$ the dimension of the PC vector space in which the stochastic coefficients are expanded, the resulting discretized weak-weak formulation can be expressed as an $\mathcal{N}(P_2 + 1)$ -dimensional linear algebraic equation for the unknown $(u_i)_{0 \leq i \leq P_2} \in \mathbb{R}^{\mathcal{N}}$,

$$\begin{aligned} \sum_{i=0}^{P_2} \int_{\Omega} d\mathbf{P}(\omega) H_i(\xi_1(\omega), \dots, \xi_p(\omega)) H_j(\xi_1(\omega), \dots, \xi_p(\omega)) \left(\mathbf{K}_0 + \sum_{k=1}^{P_1} \mathbf{K}_k H_k(\xi_1(\omega), \dots, \xi_p(\omega)) \right) u_i \\ = \int_{\Omega} d\mathbf{P}(\omega) f H_j(\xi_1(\omega), \dots, \xi_p(\omega)), \quad 0 \leq j \leq P_2, \end{aligned}$$

where $\mathbf{K}_0 + \sum_{k=1}^{P_1} \mathbf{K}_k H_k$ is the stiffness matrix obtained after expansion of the stochastic coefficients and discretization in the physical variable $x \in \Omega$.

The SRBM solution is finally sought in a low-order Krylov subspace⁴ of dimension m for the linear system above pre-conditioned by a “stiffness operator”; the latter, a block-diagonal matrix with $(P_2 + 1)$ diagonal entries $(\mathbf{K}_0^{-1})_{i,i}$ of dimension $\mathcal{N} \times \mathcal{N}$, is chosen to (ensure that the basis functions remain in the proper space as well as) improve the convergence rate of the SRBM approximation. More precisely, the SRBM solution is written as $u_i = \sum_{l=1}^m \psi_i^l c^l$, where for $1 \leq l \leq m$ the c^l are the coefficients for the Krylov vectors $(\psi_i^l)_{0 \leq i \leq P_2}$ defined by (here we assume the source term f is non-random)

$$\psi_i^1 = \mathbf{K}_0^{-1} f \text{ if } i = 0 \text{ only,}$$

$$\psi_i^l = \frac{1}{\int_{\Omega} d\mathbf{P}(\omega) H_i^2} \mathbf{K}_0^{-1} \left(\sum_{k=0}^{P_1} \mathbf{K}_k \sum_{j=0}^{P_2} \int_{\Omega} d\mathbf{P}(\omega) H_i H_j H_k \psi_j^{l-1} \right), \quad 0 \leq i \leq P_2, \quad 2 \leq l \leq m.$$

The method yields quite good results even for very low-order PC expansions ($P_2 = O(10)$) and small Krylov subspaces ($m \leq 7$). However, it is not clear how the approximation error scales with P_2 or m , and at present there appears to be no direct control of the approximation error — no *a posteriori* estimators.

⁴Similar ideas based on Krylov subspace methods have also been successfully applied in the context of parallel solvers [19], though at the price of a rather technical implementation strategy.

2.4 Random Input Field

2.4.1 Karhunen-Loève Expansions of Random Fields

To develop efficient numerical procedures for SPDEs, it remains to discretize the random input field $\text{Bi}(x, \omega)$ consistently with the discretization of the BVP problem and with a view to efficient computation of the outputs. (This is true for all the formulations introduced in the previous Section 2.3.) The (de)coupling of the space variable $x \in \mathcal{D}$ and the probability variable $\omega \in \Omega$ — leading to an “affine” parametrized weak form — is also an important feature of our numerical approach. In practical engineering situations, $\text{Bi}(x, \omega)$ may be constructed from a few measurements only, which in turn yields a *finite* collection of correlated random numbers mapped to a *finite* number of points in the physical domain \mathcal{D} . In the present work, we shall introduce random input fields $\text{Bi}(x, \omega)$ (theoretically) defined by an *infinite* collection of correlated random numbers mapped to an *infinite* number of points in the physical domain \mathcal{D} .

We introduce the random input field $\text{Bi}(x, \omega)$ through its Karhunen-Loève expansion, which is in turn characterized by the expected value as a function of $x \in \mathcal{D}$, the autocorrelation (or autocovariance) kernel in $\mathcal{D} \times \mathcal{D}$, and a countable number of (uncorrelated) random variables (as many as the rank of the autocovariance kernel). In this section, we briefly recall — solely for completeness and for notational purposes — given a particular class of random fields $\text{Bi}(x, \omega)$, how to define KL expansions that have good properties upon insertion, as a stochastic coefficient, into the Ω -strong/ \mathcal{D} -weak formulation of the BVP (10). We shall use the Riesz representation theorem in the Hilbert space $H = L^2(\partial\mathcal{D})$ to identify the topological dual $H' = L^2(\partial\mathcal{D})'$ with $H = L^2(\partial\mathcal{D})$, thus making the duality pairing $\langle \cdot, \cdot \rangle_{H'H}$ in $L^2(\partial\mathcal{D})$ identifiable with the L^2 inner product $(\cdot, \cdot)_{0, \partial\mathcal{D}}$.

Proposition 1. *Random fields $\text{Bi}(x, \omega) \in L^2_{\mathbf{P}}(\Omega, H)$ are in one-to-one correspondence with couples $(\mathbf{E}_{\mathbf{P}}(\text{Bi}), \mathbf{Cov}_{\mathbf{P}}(\text{Bi})) \in H \times L^2(\partial\mathcal{D} \times \partial\mathcal{D})$ when the kernel $\mathbf{Cov}_{\mathbf{P}}(\text{Bi})$ defines a positive, self-adjoint, trace class linear operator $\tilde{T} \in \mathcal{L}(H, H)$,*

$$(\tilde{T}f)(x) = \int_{\partial\mathcal{D}} \mathbf{Cov}_{\mathbf{P}}(\text{Bi})(x, y) f(y) dy, \quad \forall f \in H, \quad (17)$$

of (possibly infinite) rank \mathcal{K} , and when supplied with a collection of mutually uncorrelated random variables $\{Z_k(\omega); 1 \leq k \leq \mathcal{K}\}$ in $L^2_{\mathbf{P}}(\Omega)$ with zero mean and uniform variance $\mathbf{Var}_{\mathbf{P}}(Z_k) = 1, 1 \leq k \leq \mathcal{K}$.

Furthermore, random fields in $L^2_{\mathbf{P}}(\Omega, H)$ have the following Karhunen-Loève expansion [20]

$$\text{Bi}(x, \omega) = \mathbf{E}_{\mathbf{P}}(\text{Bi})(x) + \sum_{k=1}^{\mathcal{K}} \sqrt{\tilde{\lambda}_k} \Phi_k(x) Z_k(\omega), \quad (18)$$

where $\{\tilde{\lambda}_k; 1 \leq k \leq \mathcal{K}\}$ are the positive eigenvalues (in descending order) of the positive, self-adjoint, trace class operator \tilde{T} associated with eigenvectors $\{\Phi_k(x) \in H; 1 \leq k \leq \mathcal{K}\}$ (orthonormal in the H -inner-product).

Proof. Let $\text{Bi}(x, \omega)$ be a random input field in $L_{\mathbf{P}}^2(\Omega, H)$. By the Riesz representation theorem, there exists $\mathbf{E}_{\mathbf{P}}(\text{Bi}) \in H$ such that

$$\int_{\partial\mathcal{D}} \mathbf{E}_{\mathbf{P}}(\text{Bi}) f := \mathbf{E}_{\mathbf{P}} \left(\int_{\partial\mathcal{D}} \text{Bi}(x, \omega) f(x) dx \right), \quad \forall f \in H .$$

Next, we define a linear operator $R(\text{Bi}) \in \mathcal{L}(H, \mathbb{R})$

$$R(\text{Bi})f = \int_{\partial\mathcal{D}} (\text{Bi} - \mathbf{E}_{\mathbf{P}}(\text{Bi})) f, \quad \forall f \in H ,$$

which can be prolonged to $R(\text{Bi}) \in \mathcal{L}(L_{\mathbf{P}}^2(\Omega, H), L_{\mathbf{P}}^2(\Omega))$. The positive, self-adjoint, trace class operator $\tilde{T} \in \mathcal{L}(H, H)$ defined by

$$\langle \tilde{T}f, g \rangle = \int_{\Omega} R(\text{Bi})f \cdot R(\text{Bi})g, \quad \forall f, g \in H$$

identifies with \tilde{T} when the kernel $\mathbf{Cov}_{\mathbf{P}}(\text{Bi})(x, y)$ is defined by

$$\mathbf{Cov}_{\mathbf{P}}(\text{Bi})(x, y) = \int_{\Omega} (\text{Bi}(x, \omega) - \mathbf{E}_{\mathbf{P}}(\text{Bi})) (\text{Bi}(y, \omega) - \mathbf{E}_{\mathbf{P}}(\text{Bi})) d\mathbf{P}(\omega) .$$

The kernel $\mathbf{Cov}_{\mathbf{P}}(\text{Bi})(x, y)$ is denoted the autocovariance (or autocorrelation if normalized) of the random field $\text{Bi}(x, \omega)$.

Now, bounded (linear) operators of the trace class like \tilde{T} are compact, and there exists a complete orthonormal basis $\{\Phi_k(x); k \in \mathbb{N}_{>0}\}$ of H such that (Hilbert-Schmidt theorem)

$$(\tilde{T}f)(x) = \sum_{1 \leq k \leq \mathcal{K}} \tilde{\lambda}_k \left(\int_{\partial\mathcal{D}} \Phi_k(y) f(y) dy \right) \Phi_k(x), \quad \forall f \in H ,$$

where $\{\tilde{\lambda}_k \in \mathbb{R}; \tilde{\lambda}_k \geq \tilde{\lambda}_{k+1} > 0; 1 \leq k \leq \mathcal{K}\}$ are the eigenvalues of \tilde{T} associated with the eigenvectors $\{\Phi_k(x) \in H; 1 \leq k \leq \mathcal{K}\}$. We may then define mutually uncorrelated random variables in $L_{\mathbf{P}}^2(\Omega)$ with zero mean and uniform variance $\mathbf{Var}_{\mathbf{P}}(Z_k) = 1$ by

$$Z_k(\omega) = \frac{1}{\sqrt{\tilde{\lambda}_k}} R(\text{Bi}) \Phi_k, \quad \forall 1 \leq k \leq \mathcal{K} ,$$

such that

$$\text{Bi}(x, \omega) - \mathbf{E}_{\mathbf{P}}(\text{Bi}(x, \cdot)) = \sum_{k=1}^{\mathcal{K}} \sqrt{\tilde{\lambda}_k} \Phi_k(x) Z_k(\omega) .$$

Note that $\text{tr}(\tilde{T}) = \sum_{1 \leq k \leq \mathcal{K}} \tilde{\lambda}_k = \int_{\partial\mathcal{D}} \mathbf{Var}_{\mathbf{P}}(\text{Bi})$ and $\mathbf{E}_{\mathbf{P}}(Z_k) = 0$, $\mathbf{E}_{\mathbf{P}}(Z_k Z_{k'}) = \delta_{k,k'}$, $1 \leq k, k' \leq \mathcal{K}$ (using Kronecker notations). Reciprocally, to any couple $\mathbf{E}_{\mathbf{P}}(\text{Bi})$, $\mathbf{Cov}_{\mathbf{P}}(\text{Bi}) \in H \times L^2(\partial\mathcal{D} \times \partial\mathcal{D})$ where $\mathbf{Cov}_{\mathbf{P}}(\text{Bi})$ defines a positive self-adjoint trace class operator, one can associate a random field $\text{Bi}(x, \omega) \in L_{\mathbf{P}}^2(\Omega, H)$ through the KL expansion (18) (which converges because of the trace class assumption) using any mutually uncorrelated random variables $\{Z_k(\omega); 1 \leq k \leq \mathcal{K}\}$ in $L_{\mathbf{P}}^2(\Omega)$ satisfying $\mathbf{E}_{\mathbf{P}}(Z_k) = 0$ and $\mathbf{E}_{\mathbf{P}}(Z_k Z_{k'}) = \delta_{k,k'}$ for all $1 \leq k, k' \leq \mathcal{K}$. \square

In the following we shall assume that the random input field does indeed satisfy $\text{Bi}(x, \omega) \in L^2(\partial\mathcal{D}, L^2_{\mathbf{P}}(\Omega))$. Moreover, we will define a scaling parameter $\tilde{\Upsilon} > 0$ such that

$$\tilde{\Upsilon}^2 := \int_{\partial\mathcal{D}} \mathbf{Var}_{\mathbf{P}}(\text{Bi}) ,$$

and then re-scale the collection of positive eigenvalues as

$$\lambda_k := \frac{\tilde{\lambda}_k}{\tilde{\Upsilon}^2}$$

to obtain the following KL expansion from Proposition (1)

$$\text{Bi}(x, \omega) = \mathbf{E}_{\mathbf{P}}(\text{Bi})(x) + \tilde{\Upsilon} \sum_{k=1}^{\mathcal{K}} \sqrt{\lambda_k} \Phi_k(x) Z_k(\omega) . \quad (19)$$

Lastly, when \mathcal{K} is infinite or too large, numerical approaches exploit, instead of the full KL expansion, KL truncations of order K ($K \in \mathbb{N}$, $0 < K < \mathcal{K}$) which we write as

$$\text{Bi}_K(x, \omega) = \mathbf{E}_{\mathbf{P}}(\text{Bi}(x, \cdot)) + \tilde{\Upsilon} \sum_{k=1}^K \sqrt{\lambda_k} \Phi_k(x) Z_k(\omega) . \quad (20)$$

The truncation error satisfies

$$\mathbf{E}_{\mathbf{P}}\left((\text{Bi} - \text{Bi}_K)^2\right) = \tilde{\Upsilon}^2 \sum_{k=K+1}^{\mathcal{K}} \lambda_k \Phi_k^2(x) \quad (21)$$

where as $K \rightarrow \mathcal{K}$ the latter converges to zero in $L^1(\partial\mathcal{D})$.

2.4.2 Additional Assumptions on the Random Input Field

For numerical applications in the next section, the Biot number is a positive random field $\text{Bi}(x, \omega)$ on Γ_{B} , where we recall that $\omega \in \Omega$ is the random parameter varying in the probability domain Ω . For well-posedness of the BVP, we shall require

$$\text{Bi}, \text{Bi}^{-1} \in L^\infty(\Gamma_{\text{B}}, L^\infty_{\mathbf{P}}(\Omega)) ;$$

equivalently, there exist two constants $0 < \bar{b}_{\min} < \bar{b}_{\max} < +\infty$ such that $\text{Bi} \in (\bar{b}_{\min}, \bar{b}_{\max})$ a.e. in $\Gamma_{\text{B}} \times \Omega$. Since this implies $\text{Bi} \in L^2(\Gamma_{\text{B}}, L^2_{\mathbf{P}}(\Omega))$, the random fields are equivalently determined by (see Proposition 1)

- (i) an expected value function $\mathbf{E}_{\mathbf{P}}(\text{Bi})(x): x \in \Gamma_{\text{B}} \rightarrow \mathbb{R}$ in $L^\infty(\Gamma_{\text{B}}) \subset L^2(\Gamma_{\text{B}})$,
- (ii) a covariance function $\mathbf{Cov}_{\mathbf{P}}(\text{Bi})(x, y): (x, y) \in \Gamma_{\text{B}} \times \Gamma_{\text{B}} \rightarrow \mathbb{R}$ in $L^2(\Gamma_{\text{B}} \times \Gamma_{\text{B}})$ that is the kernel of a positive self-adjoint trace class operator of rank \mathcal{K} with eigenpairs $(\tilde{\Upsilon}^2 \lambda_k, \Phi_k)$ ($\lambda_k \geq \lambda_{k+1} > 0$, $1 \leq k \leq \mathcal{K}$) satisfying

$$\int_{\Gamma_{\text{B}}} \mathbf{Cov}_{\mathbf{P}}(\text{Bi})(x, y) \Phi_k(y) dy = \tilde{\Upsilon}^2 \lambda_k \Phi_k(x), \quad \forall x \in \Gamma_{\text{B}} , \quad (22)$$

for $\tilde{\Upsilon}^2 = \int_{\Gamma_{\text{B}}} \int_{\Gamma_{\text{B}}} \mathbf{Cov}_{\mathbf{P}}(\text{Bi})(x, y) dx dy$, and

(iii) mutually uncorrelated random variables $\{Z_k(\omega); 1 \leq k \leq \mathcal{K}\}$ with zero mean and unity variance $\mathbf{Var}_{\mathbf{P}}(Z_k) = 1$ in $L_{\mathbf{P}}^{\infty}(\Omega) \subset L_{\mathbf{P}}^2(\Omega)$,

through the Karhunen-Loève (KL) expansion

$$\mathbf{Bi}(x, \omega) = \overline{\mathbf{Bi}} \left(G(x) + \Upsilon \sum_{k=1}^{\mathcal{K}} \sqrt{\lambda_k} \Phi_k(x) Z_k(\omega) \right). \quad (23)$$

Here $G \in L^{\infty}(\Gamma_B)$ is a prescribed (deterministic) positive function such that $\frac{1}{|\Gamma_B|} \int_{\Gamma_B} G(x) = 1$ and hence

$$\frac{1}{|\Gamma_B|} \int_{\Gamma_B} \mathbf{E}_{\mathbf{P}}(\mathbf{Bi})(x) dx = \overline{\mathbf{Bi}};$$

furthermore, $\tilde{\Upsilon} = \overline{\mathbf{Bi}}\Upsilon$.

For a nonnegative integer $1 \leq K \leq \mathcal{K}$, we then introduce the truncated version of the KL expansion (23),

$$\mathbf{Bi}_K(x, \omega) = \overline{\mathbf{Bi}} \left(G(x) + \Upsilon \sum_{k=1}^K \sqrt{\lambda_k} \Phi_k(x) Z_k(\omega) \right). \quad (24)$$

For the sake of consistency of the numerical discretization, we shall require that the random input field $\mathbf{Bi}(x, \omega)$ be chosen such that

$$\|\mathbf{Bi}(x, \omega) - \mathbf{Bi}_K(x, \omega)\|_{L^{\infty}(\Gamma_B, L_{\mathbf{P}}^{\infty}(\Omega))} \xrightarrow{K \rightarrow \mathcal{K}} 0, \quad (25)$$

which is stronger than (21) and can be achieved for instance by choosing

(H1) a smooth covariance function $\mathbf{Cov}_{\mathbf{P}}(\mathbf{Bi})$ such that

(H1a) the eigenvectors are uniformly bounded by some positive real number $\phi > 0$

$$\|\Phi_k\|_{L^{\infty}(\Gamma_B)} \leq \phi, \quad 1 \leq k \leq \mathcal{K}, \quad (26)$$

and

(H1b) the eigenvalues decay sufficiently rapidly,

$$\sum_{k=1}^{\mathcal{K}} \sqrt{\lambda_k} < \infty, \quad (27)$$

and

(H2) uniformly bounded random variables (say) $\{Z_k; |Z_k(\omega)| < \sqrt{3}, \mathbf{P}\text{-a.s.}\}$.

In the following, and for the numerical results in particular, we shall consider Gaussian covariances $\mathbf{Cov}_{\mathbf{P}}(\mathbf{Bi})(x, y) = (\overline{\mathbf{Bi}}\Upsilon)^2 e^{-\frac{(x-y)^2}{\delta^2}}$, with δ a positive real constant; this choice complies with the requirements above [12]. The fast decay of the eigenvalues

in the Gaussian case play an important role in the fast convergence of any numerical discretization based on KL expansions of the input random field; as we shall see, this is true also for our RB approach — the eigenvalues determine the ranges of the parameters, which in turn affect the dimension of the RB space.

Next, we shall also insist upon

(H3) *independent* (thus mutually uncorrelated) random variables $\{Z_k; 1 \leq k \leq \mathcal{K}\}$,

(H4) Z_k , $1 \leq k \leq K$, i.i.d. according to the uniform density with respect to the Lebesgue measure on \mathbb{R} in the range $(-\sqrt{3}, \sqrt{3})$,

and

(H5) Υ chosen such that

$$\tau_0 := \sqrt{3}\Upsilon \sum_{k=1}^{\mathcal{K}} \sqrt{\lambda_k} \|\Phi_k\|_{L^\infty(\Gamma_B)} \leq \frac{\min_{x \in \Gamma_B} G(x)}{2}. \quad (28)$$

Then, under our assumptions, the truncation error $\|\text{Bi}(x, \omega) - \text{Bi}_K(x, \omega)\|_{L^\infty(\Gamma_B, L^\infty_{\mathbf{F}}(\Omega))}$ is bounded (for each $1 \leq K \leq \mathcal{K}$) by

$$\tau_K := \sqrt{3}\Upsilon \sum_{k=K+1}^{\mathcal{K}} \sqrt{\lambda_k} \|\Phi_k\|_{L^\infty(\Gamma_B)}, \quad (29)$$

and furthermore for $0 < \bar{b}_{\min} \leq \frac{\bar{\text{Bi}}}{2} \min_{x \in \Gamma_B} G(x)$ we have

$$\text{Bi}_K \geq \bar{b}_{\min} > 0 \text{ P-a.s., a.e. in } \mathcal{D}, \quad 1 \leq K \leq \mathcal{K}. \quad (30)$$

Remark 2.2 (Choice of the random variables $\{Z_k(\omega)\}$). *Note that there are many other interesting cases where, for a given smooth covariance function, the random variables $\{Z_k(\omega)\}$ are not uniformly distributed. These cases will be considered in future studies as they necessitate refinements that would complicate this first exposition of our viewpoint.*

3 Reduced Basis Approach for Monte-Carlo Evaluations

3.1 Discretization of a Test Problem in Strong-Weak Formulation

We now equip the Sobolev space $X := H^1(\mathcal{D})$ with the following inner product for all $v, w \in X$

$$(w, v)_X = \int_{\mathcal{D}_1} \nabla w \cdot \nabla v + \int_{\mathcal{D}_2} \nabla w \cdot \nabla v + \int_{\Gamma_B} wv, \quad (31)$$

and induced norm $\|v\|_X = \sqrt{(v, v)_X}$. It is a standard result that the norm $\|\cdot\|_X$ is equivalent to the usual norm $\|\cdot\|_{1, \mathcal{D}}$ defined previously. We also introduce a finite element (FE) subspace $X_{\mathcal{N}} \subset X$ of dimension \mathcal{N} which inherits the inner product and

norm of X . For functions $v \in X_{\mathcal{N}}$, it is possible to define a trace $v|_{\Gamma_B} \in L^2(\Gamma_B)$ which satisfies

$$\|v\|_{0,\Gamma_B} \leq \gamma_{\mathcal{N}} \|v\|_X, \quad (32)$$

where the constant $\gamma_{\mathcal{N}}$ depends only on \mathcal{D} and is bounded above for all \mathcal{N} since

$$\gamma_{\mathcal{N}} \equiv \gamma_{\mathcal{N}}(\mathcal{D}) = \sup_{v \in X_{\mathcal{N}}} \frac{\int_{\Gamma_B} v^2}{\|v\|_X^2} \leq \gamma \equiv \sup_{v \in X} \frac{\int_{\Gamma_B} v^2}{\|v\|_X^2}. \quad (33)$$

(Note $\tilde{\gamma}$ of (5) differs from γ of (33) only because of the choice of norm.)

For \mathbf{P} -a.e. outcome $\omega \in \Omega$, we define

- (a) the temperature distribution $U(\kappa, \overline{\text{Bi}})(\omega) \in X$ in \mathcal{D} ,
- (b) an approximation $U_{,K}(\kappa, \overline{\text{Bi}})(\omega) \in X$ to the temperature distribution in \mathcal{D} for Bi approximated by Bi_K ,
- (c) a FE approximation $U_{\mathcal{N}}(\kappa, \overline{\text{Bi}})(\omega) \in X_{\mathcal{N}}$ to the temperature distribution in \mathcal{D} , and
- (d) a FE approximation $U_{\mathcal{N},K}(\kappa, \overline{\text{Bi}})(\omega) \in X_{\mathcal{N}}$ to the temperature distribution \mathcal{D} for Bi approximated by Bi_K ,

as respective solutions to the following variational formulations parametrized by $(\kappa, \overline{\text{Bi}})$

$$\begin{aligned} \int_{\mathcal{D}_1} \nabla U_{(\mathcal{N})(,K)}(\kappa, \overline{\text{Bi}})(\omega) \cdot \nabla v + \kappa \int_{\mathcal{D}_2} \nabla U_{(\mathcal{N})(,K)}(\kappa, \overline{\text{Bi}})(\omega) \cdot \nabla v \\ + \int_{\Gamma_B} \text{Bi}_{(,)(K)}(x, \omega) U_{(\mathcal{N})(,K)}(\kappa, \overline{\text{Bi}})(\omega) v = \int_{\Gamma_R} v, \quad \forall v \in X_{(\mathcal{N})(,)} \end{aligned} \quad (34)$$

where the subscripts (\cdot) are chosen accordingly to the definition of $U, U_{,K}, U_{\mathcal{N}}, U_{\mathcal{N},K}$. Note that by $\text{Bi}_{(,)(K)}$ we mean that, when solving (34) for U (respectively $U_{\mathcal{N}}$) or $U_{,K}$ (respectively $U_{\mathcal{N},K}$) in X (respectively $X_{\mathcal{N}}$), the Biot number in the BVP shall be taken as (i) either the full KL series Bi, or (ii) the truncated KL series Bi_K , according to the desired solution — (i) for either U (or $U_{\mathcal{N}}$) and (ii) for $U_{,K}$ (or $U_{\mathcal{N},K}$); furthermore, by $X_{(\mathcal{N})(,)}$ we mean that, for a given KL series Bi (respectively Bi_K), the space in which the variational BVP (34) is posed shall be chosen as (i) either X , (ii) or $X_{\mathcal{N}}$, according to the desired solution — (i) for U (or $U_{,K}$) and (ii) for $U_{\mathcal{N}}$ (or $U_{\mathcal{N},K}$).

For \mathbf{P} -a.e. $\omega \in \Omega$, the realization or RB (intermediate) output is given by

$$S_{(\mathcal{N})(,K)}(\kappa, \overline{\text{Bi}})(\omega) := \mathcal{E} (U_{(\mathcal{N})(,K)}(\kappa, \overline{\text{Bi}})(\omega)) = \int_{\Gamma_R} U_{(\mathcal{N})(,K)}(\kappa, \overline{\text{Bi}})(\omega), \quad (35)$$

which is the integrated temperature at the bottom surface of the heat sink. We are interested in evaluating the expected value and variance of the integrated temperature $S_{(\mathcal{N})(,K)}(\kappa, \overline{\text{Bi}})(\omega)$, which are our (final) statistical outputs:

$$\mathbf{E}_{\mathbf{P}} (S_{(\mathcal{N})(,K)}(\kappa, \overline{\text{Bi}})) = \int_{\Omega} S_{(\mathcal{N})(,K)}(\kappa, \overline{\text{Bi}})(\omega) d\mathbf{P}(\omega), \quad (36)$$

$$\mathbf{Var}_{\mathbf{P}} (S_{(\mathcal{N})(,K)}(\kappa, \overline{\text{Bi}})) = \int_{\Omega} (\mathbf{E}_{\mathbf{P}} (S_{(\mathcal{N})(,K)}(\kappa, \overline{\text{Bi}})) - S_{(\mathcal{N})(,K)}(\kappa, \overline{\text{Bi}})(\omega))^2 d\mathbf{P}(\omega) \quad (37)$$

Note that these statistical outputs are deterministic functions of κ and Bi .

We note that since $\text{Bi}_K(x, \omega)$ is strictly positive on Γ_B for \mathbf{P} -a.e. $\omega \in \Omega$ and every $1 \leq K \leq \mathcal{K}$ by assumption, the variational problems (34) are well-posed in the sense of Hadamard, and the respective solutions satisfy the following bound (11) \mathbf{P} -a.s.

$$\|U_{(\mathcal{N})(,K)}(\kappa, \overline{\text{Bi}})(\omega)\|_X \leq \frac{C'_1(\mathcal{D})}{\min\{1, \kappa, \bar{b}_{\min}\}} \quad (38)$$

for some positive constant $C'_1(\mathcal{D})$. In addition, we have

Proposition 2. *Under standard regularity hypotheses (as $\mathcal{N} \rightarrow \infty$) on the family of FE spaces $X_{\mathcal{N}}$, the FE approximation converges as $\mathcal{N} \rightarrow \infty$. Furthermore, under the hypotheses of Section 2.4.2, the KL approximation converges as $K \rightarrow \mathcal{K}$. Finally, the following convergences hold \mathbf{P} -a.s.*

$$\begin{array}{ccc} S_{\mathcal{N},K}(\kappa, \overline{\text{Bi}})(\omega) & \xrightarrow{\mathcal{N} \rightarrow \infty} & S_{,K}(\kappa, \overline{\text{Bi}})(\omega) \\ K \rightarrow \mathcal{K} & \downarrow & \downarrow & K \rightarrow \mathcal{K} . \\ S_{\mathcal{N}}(\kappa, \overline{\text{Bi}})(\omega) & \xrightarrow{\mathcal{N} \rightarrow \infty} & S(\kappa, \overline{\text{Bi}})(\omega) \end{array}$$

We omit the detailed proof. The essential observation to ensure uniformity in K of convergence as $\mathcal{N} \rightarrow \infty$ is the compactness of the trace mapping from $H^1(\mathcal{D})$ into $L^2(\partial\mathcal{D})$. Then for $K \rightarrow \mathcal{K}$ we invoke continuity with respect to the $L^\infty(\Gamma_B)$ norm of Bi .

Moreover, because $S_{(\mathcal{N})(,K)}(\kappa, \overline{\text{Bi}})(\omega) \in L_{\mathbf{P}}^\infty(\Omega) \subset L_{\mathbf{P}}^2(\Omega)$,

$$\begin{array}{ccc} (\mathbf{E}_{\mathbf{P}}(S_{\mathcal{N},K}), \mathbf{Var}_{\mathbf{P}}(S_{\mathcal{N},K})) & \xrightarrow{\mathcal{N} \rightarrow \infty} & (\mathbf{E}_{\mathbf{P}}(S_{,K}), \mathbf{Var}_{\mathbf{P}}(S_{,K})) \\ K \rightarrow \mathcal{K} & \downarrow & \downarrow & K \rightarrow \mathcal{K} ; \\ (\mathbf{E}_{\mathbf{P}}(S_{\mathcal{N}}), \mathbf{Var}_{\mathbf{P}}(S_{\mathcal{N}})) & \xrightarrow{\mathcal{N} \rightarrow \infty} & (\mathbf{E}_{\mathbf{P}}(S), \mathbf{Var}_{\mathbf{P}}(S)) \end{array} \quad (39)$$

here we have used the following estimates

$$|\mathbf{E}_{\mathbf{P}}(S_1) - \mathbf{E}_{\mathbf{P}}(S_2)| \leq \int_{\Omega} d\mathbf{P}(\omega) \int_{\Gamma_R} |U_1 - U_2| \leq |\Gamma_R| \|U_1 - U_2\|_{0,\partial\mathcal{D} \times \Omega}, \quad (40)$$

$$|\mathbf{Var}_{\mathbf{P}}(S_1) - \mathbf{Var}_{\mathbf{P}}(S_2)| \leq C_0 \max_{i=1,2} \|U_i\|_{0,\partial\mathcal{D} \times \Omega} \|U_1 - U_2\|_{0,\partial\mathcal{D} \times \Omega}, \quad (41)$$

which hold for any two linear functionals S_1, S_2 of U_1, U_2 and some positive constant C_0 , as well as the uniform bounds (38) for all $U_{(\mathcal{N})(,K)}(\kappa, \overline{\text{Bi}})$, $1 \leq K \leq \mathcal{K}$.

Lastly, for all positive integer M , we introduce a collection $\Xi_M^\omega = \{\omega_1, \dots, \omega_M\}$ of M independent random numbers with the same law that can be mapped to one outcome in Ω of M independent copies of the random field $\text{Bi}(x, \omega)$. We then define, akin to (12),

empirical estimations for the expected values ($\mathbf{E}_{\mathbf{P}}(S_{(\mathcal{N},K)}), \mathbf{Var}_{\mathbf{P}}(S_{(\mathcal{N},K)})$) as

$$E_M[S_{(\mathcal{N},K)}](\kappa, \bar{\mathbf{B}}i) = \frac{1}{M} \sum_{m=1}^M S_{(\mathcal{N},K)}(\kappa, \bar{\mathbf{B}}i)(\omega_m), \quad (42)$$

$$V_M[S_{(\mathcal{N},K)}](\kappa, \bar{\mathbf{B}}i) = \frac{1}{M-1} \sum_{m=1}^M (S_{(\mathcal{N},K)}(\kappa, \bar{\mathbf{B}}i)(\omega_m) - E_M[S_{(\mathcal{N},K)}](\kappa, \bar{\mathbf{B}}i))^2 \quad (43)$$

The results in (39) for real numbers ($\mathbf{E}_{\mathbf{P}}(S_{(\mathcal{N},K)}), \mathbf{Var}_{\mathbf{P}}(S_{(\mathcal{N},K)})$) also clearly hold for the discrete sums ($E_M[S_{(\mathcal{N},K)}], V_M[S_{(\mathcal{N},K)}]$) for any $M > 0$; hence, by SLLN,

$$(E_M[S_{(\mathcal{N},K)}], V_M[S_{(\mathcal{N},K)}]) \xrightarrow{M \rightarrow \infty} (\mathbf{E}_{\mathbf{P}}(S_{(\mathcal{N},K)}), \mathbf{Var}_{\mathbf{P}}(S_{(\mathcal{N},K)}))$$

hold \mathbf{P} -a.s in Ω . This completes the convergence diagrams.

Now, assume sufficient regularity on the PDE data such that the FE approximations $U_{\mathcal{N}}(\kappa, \bar{\mathbf{B}}i)$ are sufficiently close to $U(\kappa, \bar{\mathbf{B}}i)$ (for some large \mathcal{N}) uniformly in ω , and that furthermore the accuracy required in the evaluation of the outputs $\mathbf{E}_{\mathbf{P}}(S_{(K)}), \mathbf{Var}_{\mathbf{P}}(S_{(K)})$ (respectively $E_M[S_{(K)}], V_M[S_{(K)}]$) is provided by the approximations $\mathbf{E}_{\mathbf{P}}(S_{\mathcal{N},(K)}), \mathbf{Var}_{\mathbf{P}}(S_{\mathcal{N},(K)})$ (respectively $E_M[S_{\mathcal{N},(K)}], V_M[S_{\mathcal{N},(K)}]$). Even then, the empirical estimations (42),(43) will still typically converge slowly: many evaluations of the FE approximation are required (M should be large) for the empirical estimations to be good approximations of the required statistical outputs. In addition, even if, for a given (supposedly large) M , empirical estimations (42),(43) are assumed both sufficiently close to the required outputs and accessible to numerical computation for a given fixed parameter $(\kappa, \bar{\mathbf{B}}i)$, the evaluation of $E_M[S_{\mathcal{N}}](\kappa, \bar{\mathbf{B}}i)$ and $V_M[S_{\mathcal{N}}](\kappa, \bar{\mathbf{B}}i)$ for many values of the parameter $(\kappa, \bar{\mathbf{B}}i)$ in a multi-query context is arguably prohibitive for a direct FE method. In summary, the FE method with large \mathcal{N} is too expensive to permit the rapid evaluation of empirical estimations (42),(43), first for a given large M , and second for many values of the parameter $(\kappa, \bar{\mathbf{B}}i)$ in a multi-query context in which M is fixed (presumably large).

Our Reduced Basis approach aims at reducing the computational cost of multiple (many) FE computations — without sacrificing certified accuracy — by exploiting the parametric structure of the problem through Offline-Online decompositions.

3.2 Reduced-Basis Approximation

3.2.1 A Deterministic Parametrized Problem

Before developing the RB approximation, we need to introduce a deterministic parametrized formulation of the BVP which can be (\mathbf{P} -a.s.) mapped to an (equivalent) strong-weak formulation of our SPDE.

First, we introduce the deterministic parameters $y_k \in [-\sqrt{3}\Upsilon\sqrt{\lambda_k}, +\sqrt{3}\Upsilon\sqrt{\lambda_k}]$, $1 \leq k \leq K \leq \mathcal{K}$, and set

$$y^K := (y_1, \dots, y_K) \in \Lambda_K^y$$

$$\Lambda_K^y := \left[-\sqrt{3}\Upsilon\sqrt{\lambda_1}, +\sqrt{3}\Upsilon\sqrt{\lambda_1} \right] \times \dots \times \left[-\sqrt{3}\Upsilon\sqrt{\lambda_K}, +\sqrt{3}\Upsilon\sqrt{\lambda_K} \right] \subset \mathbb{R}^K.$$

It is important to note that when the eigenvalues λ_k decay rapidly with k , the extent $2\sqrt{3}\Upsilon\sqrt{\lambda_k}$ of the intervals $[-\sqrt{3}\Upsilon\sqrt{\lambda_k}, +\sqrt{3}\Upsilon\sqrt{\lambda_k}]$ will also shrink rapidly. This small range in the y_k for larger k is one of the reasons the RB approximation developed in the subsequent section will converge quickly.⁵

For any $1 \leq K \leq \mathcal{K}$, we can thus map \mathbf{P} -a.s. the KL expansion for the Biot number and associated truncations Bi_K from a deterministic function of deterministic parameters $\{y_k\}$ (still abusively denoted Bi_K) as

$$\text{Bi}_K(x, y^K) := \overline{\text{Bi}} \left(G(x) + \sum_{k=1}^K y_k \Phi_k(x) \right), \quad \forall y^K \in \Lambda_K^y, \quad (44)$$

by the identification $y_k = Y_k(\omega)$ with

$$Y_k(\omega) = \Upsilon \sqrt{\lambda_k} Z_k(\omega), \quad 1 \leq k \leq K.$$

Note the case $K = \mathcal{K} = +\infty$ with infinitely many countable parameters has a meaning since the sum converges absolutely (in $L^\infty(\Gamma_B)$) by assumption (see Section 2.4.2).

For any $1 \leq K \leq \mathcal{K}$, we next denote the full parameter as $\mu_{(K)} := (\kappa, \overline{\text{Bi}}, y^K) \in \Lambda^\mu \equiv \Lambda^\varrho \times \Lambda_K^y$, and $u_{(\mathcal{N}), (K)}(\mu_{(K)}) \in X_{(\mathcal{N})}(\cdot)$ as the solution to (with notations obviously in accordance with the previous Section 3.1, and where μ without subscript refers to countably infinite parameters)

$$a_{(\cdot), (K)}(u_{(\mathcal{N}), (K)}(\mu_{(K)}), v; \mu_{(K)}) = f(v), \quad \forall v \in X_{(\mathcal{N})}(\cdot), \quad (45)$$

where the functional f and bilinear form $a_{(K)}$ are given by:

$$f(v) = \int_{\Gamma_R} v, \quad (46)$$

$$a_{(K)}(w, v; \mu_{(K)}) = \int_{\mathcal{D}_1} \nabla w \cdot \nabla v + \kappa \int_{\mathcal{D}_2} \nabla w \cdot \nabla v + \int_{\Gamma_B} \text{Bi}_{(K)}(x, y^K) w v. \quad (47)$$

We may then define

$$s_{(\mathcal{N}), (K)}(\mu_{(K)}) = f(u_{(\mathcal{N}), (K)}(\mu_{(K)})), \quad (48)$$

as our realization output. Clearly, for a.e. ω in Ω , provided $U_{(\mathcal{N}), (K)}(\kappa, \overline{\text{Bi}})(\omega)$ is well defined and $y^K = (Y_1(\omega), \dots, Y_K(\omega))$ ($1 \leq K \leq \mathcal{K}$),

$$u_{(\mathcal{N}), (K)}(\mu_{(K)}) = U_{(\mathcal{N}), (K)}(\kappa, \overline{\text{Bi}})(\omega),$$

$$s_{(\mathcal{N}), (K)}(\mu_{(K)}) = S_{(\mathcal{N}), (K)}(\kappa, \overline{\text{Bi}})(\omega),$$

⁵Note we can treat with a single RB many different covariance functions of varying smoothness if we introduce the parameters y_k in the interval (say) $[-\sqrt{3}\Upsilon, \sqrt{3}\Upsilon]$ independent of k such that $y \equiv (y_1, \dots, y_K) \in \mathcal{D}^y \equiv [-\sqrt{3}\Upsilon, \sqrt{3}\Upsilon]^K \subset \mathbb{R}^K$. However, in this case the reduced basis approximation will converge much more slowly since the parameter space \mathcal{D}^y is much larger.

which is the desired mapping from parametrized deterministic problem to stochastic problem.

Finally, for each $M > 0$, we \mathbf{P} -a.s. map a sample $\Xi_M^\omega = \{\omega_1, \dots, \omega_M\}$ of M independent identically distributed random numbers to a collection $\Xi_M^y = \{y^K(\omega_m), 1 \leq m \leq M\}$ of M independent copies of the random vector

$$y^K(\omega_m) = (Y_1(\omega_m), \dots, Y_K(\omega_m)), \quad 1 \leq m \leq M ,$$

for Y_k , $1 \leq k \leq K$ ($\leq \mathcal{K}$), uniformly distributed over $[-\sqrt{3}\Upsilon\sqrt{\lambda_k}, +\sqrt{3}\Upsilon\sqrt{\lambda_k}]$. Then, the full parameter $\mu(\omega_m) = (\kappa, \bar{\mathbf{B}}\mathbf{i}, y^K(\omega_m))$ is mapped to Ξ_M^ω such that the estimations

$$E_M[s_{(\mathcal{N})(,K)}](\kappa, \bar{\mathbf{B}}\mathbf{i}) = \frac{1}{M} \sum_{m=1}^M s_{(\mathcal{N})(,K)}(\mu(\omega_m)) , \quad (49)$$

$$V_M[s_{(\mathcal{N})(,K)}](\kappa, \bar{\mathbf{B}}\mathbf{i}) = \frac{1}{M-1} \sum_{m=1}^M (E_M[s_{(\mathcal{N})(,K)}](\kappa, \bar{\mathbf{B}}\mathbf{i}) - s_{(\mathcal{N})(,K)}(\mu(\omega_m)))^2 , \quad (50)$$

coincide \mathbf{P} -a.s. with $E_M[S_{(\mathcal{N})(,K)}](\kappa, \bar{\mathbf{B}}\mathbf{i})$ and $V_M[S_{(\mathcal{N})(,K)}](\kappa, \bar{\mathbf{B}}\mathbf{i})$ as statistical approximations of the expected value and variance $\mathbf{E}_{\mathbf{P}}(S_{(\mathcal{N})(,K)})(\kappa, \bar{\mathbf{B}}\mathbf{i})$ and $\mathbf{Var}_{\mathbf{P}}(S_{(\mathcal{N})(,K)})(\kappa, \bar{\mathbf{B}}\mathbf{i})$, respectively. Note that all the convergence results established in the previous Section 3.1 for \mathcal{N} , $K \rightarrow \infty$ still hold for $s_{(\mathcal{N})(,K)}$ and a fixed parameter value y^K .

In the following, we shall develop a reduced basis (RB) approximation and associated *a posteriori* error estimator which will permit rapid and reliable evaluation of the empirical approximations (49) and (50) for the outputs of interest (the expected value and variance $(\mathbf{E}_{\mathbf{P}}(S), \mathbf{Var}_{\mathbf{P}}(S))(\kappa, \bar{\mathbf{B}}\mathbf{i})$). Our RB approximation will be based upon, and the RB error will be measured relative to, the FE approximation $u_{\mathcal{N},K}(\mu_K)$ of (45). Note we assume that \mathcal{N} is chosen sufficiently large *a priori* to provide the desired accuracy relative to the exact solution; we shall thus concentrate our *a posteriori* estimation and control on the RB approximation and on the KL truncation (note it is very simple to change the order of KL truncation in a strong-weak formulation). As we shall see, the total RB cost (Offline and Online, see Section 3.4) will actually depend rather weakly on \mathcal{N} , and hence \mathcal{N} may be chosen conservatively.

3.2.2 RB Approximation

We assume that we are given N_{\max} ($N_{\max} \leq \mathcal{N}$) X -orthonormalized basis functions $\zeta_n \in X_{\mathcal{N}}$, $1 \leq n \leq N_{\max}$. We define the associated hierarchical Lagrange [28] RB spaces $X_N \subset X_{\mathcal{N}}$, $1 \leq N \leq N_{\max}$, as

$$X_N = \text{span}\{\zeta_n, 1 \leq n \leq N\}, \quad N = 1, \dots, N_{\max} . \quad (51)$$

In practice (see Section 3.4), the spaces X_N will be generated by a Greedy sampling procedure [25, 30]; for our present purpose, however, X_N can in fact represent any sequence of (low-dimensional) hierarchical approximation spaces.

The RB approximation of the problem (45) then reads: Given $\mu \in \Lambda^\mu$, we look for an RB approximation $u_{N,K}(\mu) \in X_N$ such that

$$a_K(u_{N,K}(\mu), v; \mu) = f(v), \quad \forall v \in X_N. \quad (52)$$

We then calculate the RB realization output as

$$s_{N,K}(\mu) = \int_{\Gamma_R} u_{N,K}(\mu). \quad (53)$$

The RB output will be evaluated in the Online stage, by the procedure described in Section 3.4, with a computational cost depending on N and K but *not* on \mathcal{N} : hence, for small N and K , the RB approximation can be significantly less expensive than the FE approximation.

We shall use this RB approximation to compute the expected value and variance of the output of interest. In particular, for a given integer $M > 0$ and sample Ξ_M^ω , we compute the expected value and variance of the RB output for any $(\kappa, \bar{\text{Bi}}) \in \Lambda^\ell$ as finite sums of random variables,

$$E_M[s_{N,K}](\kappa, \bar{\text{Bi}}) = \frac{1}{M} \sum_{m=1}^M s_{N,K}(\mu(\omega_m)), \quad (54)$$

$$V_M[s_{N,K}](\kappa, \bar{\text{Bi}}) = \frac{1}{M-1} \sum_{m=1}^M (E_M[s_{N,K}](\kappa, \bar{\text{Bi}}) - s_{N,K}(\mu(\omega_m)))^2. \quad (55)$$

In the next section we develop rigorous *a posteriori* bounds for these quantities relative to $E_M[s_{(\mathcal{N}),(\mathcal{K})}](\kappa, \bar{\text{Bi}})$ and $V_M[s_{(\mathcal{N}),(\mathcal{K})}](\kappa, \bar{\text{Bi}})$, respectively.

3.3 A *Posteriori* Error Estimation

3.3.1 Error Bounds for the RB Output

We note from (52) that the residual $r(v; \mu)$ associated with $u_{N,K}(\mu)$ is given by

$$r(v; \mu) = f(v) - a_K(u_{N,K}(\mu), v; \mu), \quad \forall v \in X_N; \quad (56)$$

the dual norm of the residual is given by

$$\|r(\cdot; \mu)\|_{X'_N} = \sup_{v \in X_N} \frac{r(v; \mu)}{\|v\|_X}. \quad (57)$$

(Note the dual norm is defined over the FE “truth” space.)

We next introduce a bilinear form

$$a_C(w, v; (\kappa, \bar{\text{Bi}})) = \int_{\mathcal{D}_1} \nabla w \cdot \nabla v + \kappa \int_{\mathcal{D}_2} \nabla w \cdot \nabla v + \frac{\bar{\text{Bi}}}{2} \int_{\Gamma_B} G(x) w v, \quad \forall w, v \in X_N. \quad (58)$$

Note that a_C is independent of y^K and that $a_C(v, v; (\kappa, \overline{\text{Bi}})) \leq a_K(v, v; \mu)$, $\forall \mu \in \Lambda^\mu$, $\forall v \in X_N$, since $\text{Bi}_K(x, y)$ is bounded below by $\overline{\text{Bi}} G(x)/2$. It thus follows that

$$\alpha_C(\kappa, \overline{\text{Bi}}) = \inf_{v \in X_N} \frac{a_C(v, v; (\kappa, \overline{\text{Bi}}))}{\|v\|_X^2} \leq \alpha_K(\mu), \quad \forall \mu \in \Lambda^\mu, \quad (59)$$

where $\alpha_K(\mu)$ is the coercivity constant associated with a_K ,

$$\alpha_K(\mu) = \inf_{v \in X_N} \frac{a_K(v, v; \mu)}{\|v\|_X^2}. \quad (60)$$

It should be noted that $\alpha_C(\kappa, \overline{\text{Bi}})$ depends only on the deterministic parameters κ and $\overline{\text{Bi}}$, *not* on the (ultimately mapped to a random) parameter y^K .

Finally, it is a standard result [6, 25, 30] that

$$\|u_{N,K}(\mu) - u_{N,K}(\mu)\|_X \leq \Delta_{N,K}(\mu) \equiv \frac{\|r(\cdot; \mu)\|_{X'_N}}{\alpha_{\text{LB}}(\kappa, \overline{\text{Bi}})}, \quad (61)$$

$$|s_{N,K}(\mu) - s_{N,K}(\mu)| \leq \Delta_{N,K}^s(\mu) \equiv \frac{\|r(\cdot; \mu)\|_{X'_N}^2}{\alpha_{\text{LB}}(\kappa, \overline{\text{Bi}})}, \quad (62)$$

where $\alpha_{\text{LB}}(\kappa, \overline{\text{Bi}})$ is a lower bound for $\alpha_C(\kappa, \overline{\text{Bi}})$ and thus also a lower bound for $\alpha_K(\mu)$. It remains to address the error terms induced by the KL truncation.

3.3.2 Error Bounds for the KL Truncation Effect

We now bound the error $|s_N(\mu) - s_{N,K}(\mu)|$ due to the truncation of the KL expansion. Toward this end, we first note that

$$\begin{aligned} |s_N(\mu) - s_{N,K}(\mu)| &= |f(u_N(\mu) - u_{N,K}(\mu))| \\ &\leq \|f\|_{X'_N} \|u_N(\mu) - u_{N,K}(\mu)\|_X. \end{aligned} \quad (63)$$

Moreover, as shown below, the last term is bounded by

$$\|u_N(\mu) - u_{N,K}(\mu)\|_X \leq \frac{\tau_K \gamma_N}{\alpha_{\text{LB}}(\kappa, \overline{\text{Bi}})} (\|u_{N,K}(\mu)\|_X + \Delta_{N,K}(\mu)). \quad (64)$$

It thus follows that

$$|s_N(\mu) - s_{N,K}(\mu)| \leq \Delta_{N,K}^t(\mu) \equiv \frac{\tau_K \gamma_N}{\alpha_{\text{LB}}(\kappa, \overline{\text{Bi}})} \|f\|_{X'_N} (\|u_{N,K}(\mu)\|_X + \Delta_{N,K}(\mu)). \quad (65)$$

Recall that τ_K is the error bound for $\|\text{Bi}(\cdot, y) - \text{Bi}_K(\cdot, y)\|_{L^\infty(\Gamma_B)}$ already introduced in (29) and that γ_N is the continuity constant for the trace application $X_N \rightarrow \Gamma_B$ already defined in (32).

We now prove (64). Subtracting the truncated and full problems (45) after FE discretization and choosing $v = e_{\mathcal{N},K}(\mu) = u_{\mathcal{N}}(\mu) - u_{N,K}(\mu)$, we obtain

$$a(e_{\mathcal{N},K}(\mu), e_{\mathcal{N},K}(\mu); \mu) = - \int_{\Gamma_B} (\text{Bi}(x, y) - \text{Bi}_K(x, y)) u_{\mathcal{N},K}(\mu) e_{\mathcal{N},K}(\mu) . \quad (66)$$

Furthermore, the left-hand side (LHS) of (66) is bounded below by

$$\begin{aligned} \text{LHS} &\geq a_C(e_{\mathcal{N},K}(\mu), e_{\mathcal{N},K}(\mu); (\kappa, \overline{\text{Bi}})) \\ &\geq \alpha_{\text{LB}}(\kappa, \overline{\text{Bi}}) \|e_{\mathcal{N},K}(\mu)\|_X^2 , \end{aligned} \quad (67)$$

and the right-hand side (RHS) of (66) is bounded above by

$$\begin{aligned} |\text{RHS}| &\leq \tau_K \|u_{\mathcal{N},K}(\mu)\|_{L^2(\Gamma_B)} \|e_{\mathcal{N},K}\|_{L^2(\Gamma_B)} \\ &\leq \tau_K \gamma_{\mathcal{N}} \|u_{\mathcal{N},K}(\mu)\|_X \|e_{\mathcal{N},K}(\mu)\|_X \\ &\leq \tau_K \gamma_{\mathcal{N}} (\|u_{N,K}(\mu)\|_X + \Delta_{N,K}(\mu)) \|e_{\mathcal{N},K}(\mu)\|_X . \end{aligned} \quad (68)$$

The desired result, (64), follows directly from (66)–(68).

3.3.3 Error Bounds for the Expected Value and Variance

From the results obtained in the previous sections we have, from the triangle inequality,

$$|s_{\mathcal{N}}(\mu) - s_{N,K}(\mu)| \leq \Delta_{N,K}^o(\mu) , \quad (69)$$

where

$$\Delta_{N,K}^o(\mu) = \Delta_{N,K}^s(\mu) + \Delta_{N,K}^t(\mu) . \quad (70)$$

Thus we obtain the error bound for the error in the expected value \mathbf{P} -a.e. in Ω

$$|E_M[s_{\mathcal{N}}](\kappa, \overline{\text{Bi}}) - E_M[s_{N,K}](\kappa, \overline{\text{Bi}})| \leq \Delta_E^o[s_{N,K}](\kappa, \overline{\text{Bi}}) = \Delta_E^s[s_{N,K}](\kappa, \overline{\text{Bi}}) + \Delta_E^t[s_{N,K}](\kappa, \overline{\text{Bi}}) , \quad (71)$$

where

$$\begin{aligned} \Delta_E^s[s_{N,K}](\kappa, \overline{\text{Bi}}) &\equiv \frac{1}{M} \sum_{m=1}^M \Delta_{N,K}^s(\mu(\omega_m)) , \\ \Delta_E^t[s_{N,K}](\kappa, \overline{\text{Bi}}) &\equiv \frac{1}{M} \sum_{m=1}^M \Delta_{N,K}^t(\mu(\omega_m)) . \end{aligned} \quad (72)$$

This error bound consists of the RB estimate (62) and the KL truncation estimate (65). The two estimates depend on both N and K but in different ways: the former will decrease rapidly with increasing N and typically increase with increasing K , while the latter will decrease rapidly with increasing K .

To construct the error bound for the error in the variance, we introduce random variables defined \mathbf{P} -a.e. in Ω for a given Ξ_M^ω as

$$\begin{aligned} A_{N,K}(\mu(\omega_m)) &:= E_M[s_{N,K}](\kappa, \bar{\mathbf{B}}i) - s_{N,K}(\mu(\omega_m)) + \Delta_{N,K}^o(\mu(\omega_m)) + \Delta_E^o[s_{N,K}](\kappa, \bar{\mathbf{B}}i) , \\ B_{N,K}(\mu(\omega_m)) &:= E_M[s_{N,K}](\kappa, \bar{\mathbf{B}}i) - s_{N,K}(\mu(\omega_m)) - \Delta_{N,K}^o(\mu(\omega_m)) - \Delta_E^o[s_{N,K}](\kappa, \bar{\mathbf{B}}i) , \\ C_{N,K}(\mu(\omega_m)) &:= \begin{cases} 0 & \text{if } [s_{N,K}^-(\mu(\omega_m)), s_{N,K}^+(\mu(\omega_m))] \cap [E_M^-[s_{N,K}](\kappa, \bar{\mathbf{B}}i), E_M^+[s_{N,K}](\kappa, \bar{\mathbf{B}}i)] \neq \emptyset \\ \min\{|A_{N,K}(\mu(\omega_m))|, |B_{N,K}(\mu(\omega_m))|\} & \text{otherwise} \end{cases} , \\ D_{N,K}(\mu(\omega_m)) &:= \max\{|A_{N,K}(\mu(\omega_m))|, |B_{N,K}(\mu(\omega_m))|\} , \end{aligned} \tag{73}$$

where $s_{N,K}^\pm(\mu(\omega_m)) = s_{N,K}(\mu(\omega_m)) \pm \Delta_{N,K}^o(\mu(\omega_m))$ and $E_M^\pm[s_{N,K}](\kappa, \bar{\mathbf{B}}i) = E_M[s_{N,K}](\kappa, \bar{\mathbf{B}}i) \pm \Delta_E^o[s_{N,K}](\kappa, \bar{\mathbf{B}}i)$. We thus have \mathbf{P} -a.s.

$$C_{N,K}^2(\mu(\omega_m)) \leq (E_M[s_{N,K}](\kappa, \bar{\mathbf{B}}i) - s_{N,K}(\mu(\omega_m)))^2 \leq D_{N,K}^2(\mu(\omega_m)) , \tag{74}$$

and hence, also \mathbf{P} -a.s.

$$V_M^{\text{LB}}[s_{N,K}](\kappa, \bar{\mathbf{B}}i) \leq V_M[s_{N,K}](\kappa, \bar{\mathbf{B}}i) \leq V_M^{\text{UB}}[s_{N,K}](\kappa, \bar{\mathbf{B}}i) , \tag{75}$$

where \mathbf{P} -a.e. in Ω

$$\begin{aligned} V_M^{\text{LB}}[s_{N,K}](\kappa, \bar{\mathbf{B}}i) &:= \frac{1}{M-1} \sum_{m=1}^M C_{N,K}^2(\mu(\omega_m)) , \\ V_M^{\text{UB}}[s_{N,K}](\kappa, \bar{\mathbf{B}}i) &:= \frac{1}{M-1} \sum_{m=1}^M D_{N,K}^2(\mu(\omega_m)) . \end{aligned} \tag{76}$$

Thus we obtain \mathbf{P} -a.s. a bound for the error in the variance as

$$|V_M[s_{N,K}](\kappa, \bar{\mathbf{B}}i) - V_M[s_{N,K}](\kappa, \bar{\mathbf{B}}i)| \leq \Delta_V^o[s_{N,K}](\kappa, \bar{\mathbf{B}}i) , \tag{77}$$

where the error bound $\Delta_V^o[s_{N,K}](\kappa, \bar{\mathbf{B}}i)$ is defined \mathbf{P} -a.e. in Ω as

$$\begin{aligned} \Delta_V^o[s_{N,K}](\kappa, \bar{\mathbf{B}}i) &:= \max \{ |V_M[s_{N,K}](\kappa, \bar{\mathbf{B}}i) - V_M^{\text{UB}}[s_{N,K}](\kappa, \bar{\mathbf{B}}i)| , \\ &|V_M[s_{N,K}](\kappa, \bar{\mathbf{B}}i) - V_M^{\text{LB}}[s_{N,K}](\kappa, \bar{\mathbf{B}}i)| \} . \end{aligned} \tag{78}$$

This variance error bound also includes both an RB contribution and a KL truncation contribution.

Finally, although it is not our main goal, we point out that without consideration of the KL truncation effect we may also obtain the error bounds (at fixed K)

$$\begin{aligned} |E_M[s_{N,K}](\kappa, \bar{\mathbf{B}}i) - E_M[s_{N,K}](\kappa, \bar{\mathbf{B}}i)| &\leq \Delta_E^s[s_{N,K}](\kappa, \bar{\mathbf{B}}i) , \\ |V_M[s_{N,K}](\kappa, \bar{\mathbf{B}}i) - V_M[s_{N,K}](\kappa, \bar{\mathbf{B}}i)| &\leq \Delta_V^s[s_{N,K}](\kappa, \bar{\mathbf{B}}i) . \end{aligned} \tag{79}$$

Here $\Delta_E^s[s_{N,K}](\kappa, \overline{\text{Bi}})$ is given by (72), and $\Delta_V^s[s_{N,K}](\kappa, \overline{\text{Bi}})$ is defined in the same way as $\Delta_V^o[s_{N,K}](\kappa, \overline{\text{Bi}})$ but replacing $\Delta_{N,K}^o(\mu(\omega_m))$ with $\Delta_{N,K}^s(\mu(\omega_m))$ and $\Delta_E^o[s_{N,K}](\kappa, \overline{\text{Bi}})$ with $\Delta_E^s[s_{N,K}](\kappa, \overline{\text{Bi}})$ in (73). We introduce

$$\Delta_V^t[s_{N,K}](\kappa, \overline{\text{Bi}}) = \Delta_V^o[s_{N,K}](\kappa, \overline{\text{Bi}}) - \Delta_V^s[s_{N,K}](\kappa, \overline{\text{Bi}}) ; \quad (80)$$

then $\Delta_V^t[s_{N,K}](\kappa, \overline{\text{Bi}})$ is regarded as the contribution due to the KL truncation to the variance error bound (78).

3.4 Offline-Online Computational Approach

3.4.1 Construction-Evaluation Decomposition

The system (52) comprises N linear algebraic equations in N unknowns. However, its formation involves entities $\zeta_n, 1 \leq n \leq N$, associated with the \mathcal{N} -dimensional FE approximation space. If we must invoke FE fields in order to form the system *for each new value of μ* the marginal cost per input-output evaluation $\mu \rightarrow s_{N,K}(\mu)$ will remain unacceptably large. Fortunately, we can compute this output very efficiently by constructing Offline-Online procedures [25, 29, 30], as we now discuss.

First, we note that the bilinear form a_K as introduced in (47) can be expressed as the following ‘‘affine’’ decomposition

$$a_K(w, v; \mu) = \sum_{k=1}^{K+3} \Theta^k(\mu) a^k(w, v) . \quad (81)$$

Here $\Theta^1(\mu) = 1$, $\Theta^2(\mu) = \kappa$, $\Theta^3(\mu) = \overline{\text{Bi}}$, and $\Theta^{3+k}(\mu) = \overline{\text{Bi}} y_k$, $1 \leq k \leq K$, are parameter-*dependent* functions, and $a^1(w, v) = \int_{\mathcal{D}_1} \nabla w \cdot \nabla v$, $a^2(w, v) = \int_{\mathcal{D}_2} \nabla w \cdot \nabla v$, $a^3(w, v) = \int_{\Gamma_B} G(x) w v$, and $a^{3+k}(w, v) = \int_{\Gamma_B} \Phi_k(x) w v$, $1 \leq k \leq K$, are parameter-*independent* bilinear forms. Note the crucial role of the ‘‘separable’’ (in ω and x) form of the KL expansion is ensuring an affine representation; the affine representation is, in turn, crucial to the Offline-Online strategy.

We next express $u_{N,K}(\mu) = \sum_{m=1}^N c_{N,K,m}(\mu) \zeta_m$, choose $v = \zeta_n$, $1 \leq n \leq N$, and invoke the affine representation (81) to write the system (52) as

$$\sum_{m=1}^N \left(\sum_{k=1}^{K+3} \Theta^k(\mu) a^k(\zeta_m, \zeta_n) \right) c_{N,K,m}(\mu) = f(\zeta_n), \quad 1 \leq n \leq N , \quad (82)$$

and subsequently evaluate our RB output as

$$s_{N,K}(\mu) = \sum_{n=1}^N c_{N,K,n}(\mu) f(\zeta_n) . \quad (83)$$

We observe that the quantities $a^k(\zeta_m, \zeta_n)$ and $f(\zeta_n)$ are independent of μ and thus can be pre-computed in a Construction-Evaluation decomposition.

In the Construction phase, we form and store the $f(\zeta_n)$ and $a^k(\zeta_m, \zeta_n)$, $1 \leq n, m \leq N_{\max}$, $1 \leq k \leq K+3$. In the Evaluation phase, we first perform the sum $\sum_{k=1}^{K+3} \Theta^k(\mu) a^k(\zeta_m, \zeta_n)$, we next solve the resulting $N \times N$ system (82) to obtain the $c_{N,K,n}(\mu)$, $1 \leq n \leq N$, and finally we evaluate the output (83). The operation count for the Evaluation phase is $O((K+3)N^2)$ to perform the sum, $O(N^3)$ to invert (82), and finally $O(N)$ to effect the inner product (83); the storage for the Evaluation phase (the data archived in the Construction phase) is only $O(N_{\max} + (K+3)N_{\max}^2)$. The Evaluation cost (operation cost and storage) — and hence marginal cost and also asymptotic average cost — to evaluate $\mu \rightarrow s_{N,K}(\mu)$ is thus independent of \mathcal{N} . The implications are twofold: first, if N and K are indeed small, we shall achieve very fast response in many-query contexts (in which the initial Offline investment is eventually “forgotten”); second, we may choose \mathcal{N} very conservatively — to effectively eliminate the error between the exact and FE predictions — without adversely affecting the Evaluation (marginal) cost.

The Construction-Evaluation for the error bounds is a bit more involved. To begin, we note from standard duality arguments that $\|r(\cdot; \mu)\|_{X_{\mathcal{N}}} = \|\mathcal{R}(\mu)\|_X$; here $\mathcal{R}_N(\mu) \in X_{\mathcal{N}}$ satisfies $(\mathcal{R}(\mu), v)_X = r(v; \mu)$, $\forall v \in X_{\mathcal{N}}$, where $r(v; \mu) \equiv f(v) - a_K(u_N(\mu), v; \mu)$, $\forall v \in X_{\mathcal{N}}$, is the residual introduced earlier. We can thus express (61) and (62) as

$$\Delta_{N,K}(\mu) = \frac{\|\mathcal{R}(\mu)\|_X}{\alpha_{\text{LB}}(\kappa, \overline{\text{Bi}})}, \quad \text{and} \quad \Delta_{N,K}^s(\mu) = \frac{\|\mathcal{R}(\mu)\|_X^2}{\alpha_{\text{LB}}(\kappa, \overline{\text{Bi}})}. \quad (84)$$

There are two components to the error bounds: the dual norm of the residual, $\|\mathcal{R}(\mu)\|_X$, and our lower bound for the coercivity constant, $\alpha_{\text{LB}}(\kappa, \overline{\text{Bi}})$. The Construction-Evaluation decomposition for the coercivity constant lower bound is based on the Successive Constraint Method (SCM) described in detail in [7, 16, 30]. We focus here on the Construction-Evaluation decomposition for the dual norm of the residual.

To address the dual norm of the residual, we first express our residual $r(v; \mu)$ in terms of (81) to obtain

$$(\mathcal{R}(\mu), v)_X = f(v) - \sum_{k=1}^{K+3} \sum_{n=1}^N \Theta^k(\mu) c_{N,K,n}(\mu) a^k(\zeta_n, v),$$

and hence by linear superposition

$$\mathcal{R}(\mu) = z_0 + \sum_{k=1}^{K+3} \sum_{n=1}^N \Theta^k(\mu) c_{N,K,n}(\mu) z_n^k,$$

where $(z_0, v)_X = f(v)$, $\forall v \in X_{\mathcal{N}}$, and $(z_n^k, v)_X = -a^k(\zeta_n, v)$, $\forall v \in X_{\mathcal{N}}$, $1 \leq n \leq N$, $1 \leq k \leq K+3$. We thus obtain

$$\begin{aligned} \|\mathcal{R}\|_X^2 &= (z_0, z_0)_X + 2 \sum_{k,n=1}^{K+3,N} \Theta^k(\mu) c_{N,K,n}(\mu) (z_n^k, z_0)_X + \\ &\quad \sum_{k,k',n,n'=1}^{K+3,K+3,N,N} \Theta^k(\mu) c_{N,K,n}(\mu) \Theta^{k'}(\mu) c_{N,K,n'}(\mu) (z_n^k, z_{n'}^{k'})_X. \end{aligned} \quad (85)$$

Since the $(\cdot, \cdot)_X$ inner products are independent of μ , we can pre-compute these quantities in the Construction-Evaluation decomposition.

In the Construction phase — parameter independent, and performed only once — we find $z_0, z_n^k, 1 \leq k \leq K+3, 1 \leq n \leq N$, and then form and store the inner products $(z_0, z_0)_X, (z_n^k, z_0)_X, 1 \leq k \leq K+3, 1 \leq n \leq N$, and $(z_n^k, z_{n'}^{k'})_X, 1 \leq k, k' \leq K+3, 1 \leq n, n' \leq N$. Then, in the Evaluation phase — given any desired value of μ — we simply evaluate (84) from the summation (85) and the SCM evaluation for $\alpha_{\text{LB}}(\kappa, \bar{\text{Bi}})$ at cost $O((K+3)^2 N^2)$. The crucial point, again, is that the cost and storage in the Evaluation phase — the *marginal* cost for each new value of μ — is independent of \mathcal{N} : thus we can not only evaluate our output prediction but also our rigorous output error bound very rapidly in the many-query (or real-time) context.

Finally, the error bound $\Delta_{N,K}^t(\mu)$ of (65) requires additional quantities: $\tau_K, \gamma_{\mathcal{N}}, \|f\|_{X'_{\mathcal{N}}}$, and $\|u_{N,K}(\mu)\|_X$. Note the first three quantities are independent of μ : τ_K can be pre-computed for any $1 \leq K \leq \mathcal{K}$ from the expansion (29); $\gamma_{\mathcal{N}}$ can be pre-computed from the eigenvalue problem (33); and finally $\|f\|_{X'_{\mathcal{N}}}$ can be pre-computed (by duality) as a standard FE Poisson problem. We note further that

$$\|u_{N,K}(\mu)\|_X^2 = \sum_{n,n'=1}^{N,N} c_{N,K n}(\mu) c_{N,K n'}(\mu) (\zeta_n, \zeta_{n'})_X, \quad (86)$$

which readily admits a Construction-Evaluation decomposition; clearly, the Evaluation-phase summation (86) requires only $O(N^2)$ operations. In summary, in the Evaluation phase, we can evaluate $s_{N,K}(\mu), \Delta_{N,K}^s(\mu), \Delta_{N,K}^t(\mu)$, and $\Delta_{N,K}^o(\mu)$ at total cost $O(N^3 + (K+3)^2 N^2)$ operations.

3.4.2 Greedy Sampling

Finally, we turn to the construction of our reduced basis $\zeta_n, 1 \leq n \leq N_{\text{max}}$: we pursue a very simple but also very effective Greedy procedure [30]. To initiate the Greedy procedure we specify a very large (exhaustive) “train” sample of n_{train} points in $\mathcal{D}^\mu, \Xi_{\text{train}}$, a maximum RB dimension N_{max} , and an initial (say, random) sample $S_1 = \{\mu^1\}$ and associated RB space X_1 . (In actual practice, we typically specify an error tolerance-*cum*-stopping criterion which then implicitly determines N_{max} .) We specify $K = \mathcal{K}$ (in practice, finite) for the Greedy algorithm described below.

Then, for $N = 1, \dots, N_{\text{max}}$: Step (1) Find $\mu^{N+1} = \arg \max_{\mu \in \Xi_{\text{train}}} \Delta_{N,K}(\mu)$; Step (2) Update $S_{N+1} = S_N \cup \mu^{N+1}$ and $X_{N+1} = X_N + \text{span}\{u_{N,K}(\mu^{N+1})\}$. The heuristic is simple: we append to our sample the point μ^{N+1} which is least well represented by the space X_N (as predicted by the error bound associated with our RB Galerkin approximation). In practice, the basis must be orthogonalized with respect to the $(\cdot, \cdot)_X$ inner product; the algebraic system then inherits the conditioning properties of the underlying partial differential equation. Note that the Greedy automatically generates *hierarchical* spaces $X_N, 1 \leq N \leq N_{\text{max}}$, which is computationally very advantageous.

The important point to note from the computational perspective is that the operation count for the Greedy algorithm is $O(K \cdot N \cdot \mathcal{N}) + O(K \cdot N \cdot n_{\text{train}})$ and *not* $O(\mathcal{N} \cdot n_{\text{train}})$ —

and hence much less expensive than classical approaches such as the KL (here Proper Orthogonal Decomposition, or POD) expansion. The reason is simple: In Step (1), to calculate $\Delta_{N,\mathcal{K}}(\mu)$ over Ξ_{train} , we invoke the Construction-Evaluation decomposition to obtain (per Greedy cycle) an operation count of $O(N\mathcal{K}\mathcal{N}) + n_{\text{train}}O(\mathcal{K}^2N^2)$. (Of course, much of the computational economies are due not to the Greedy *per se*, but rather to the accommodation within the Greedy of the inexpensive error bounds.) As a result, we can take n_{train} very large — often 10^4 or larger — particularly important for the high — $K + P_\varrho$ — dimensional parameter domains encountered in the SPDE context (here P_ϱ is dimension of the deterministic parameter ϱ). Furthermore, extensive numerical results for a wide variety of problems indicate that the Greedy RB space X_N is typically as good as more global (and provably optimal) approaches such as the POD [30]. (Of course, the latter result is norm dependent: the Greedy prefers $L^\infty(\Xi_{\text{train}})$, whereas the POD expansion is optimal in $L^2(\Xi_{\text{train}})$.)

3.4.3 Offline-Online Stages

Finally, we delineate Offline and Online stages. The Offline stage comprises the Greedy sampling strategy: the Offline stage of course appeals to both the Construction and Evaluation phases. The Online stage includes all subsequent evaluations of the RB output and output error bound for many-query computations: the Online stage involves only the Evaluation phase, and hence will be extremely rapid.

We now discuss the implications for the MC sums required for the evaluation of our statistical outputs — the focus of the current paper. In particular, it is clear the *total* operation count — Offline and Online — to evaluate $E_M[s_{N,K}](\cdot)$, $V_M[s_{N,K}](\cdot)$, $\Delta_E^o[s_{N,K}](\cdot)$, and $\Delta_V^o[s_{N,K}](\cdot)$ for J different values of $(\kappa, \overline{\text{Bi}})$ scales as $W_{\text{Offline}}(N_{\text{max}}, \mathcal{K}, \mathcal{N}) + W_{\text{Online}}(J, M, N, K)$, where

$$W_{\text{Online}} = JM \times O(N^3 + K^2N^2) .$$

Thus as either $M \rightarrow \infty$ or $J \rightarrow \infty$ and in particular as $J, M \rightarrow \infty$ — many evaluations of our statistical output — $W_{\text{Offline}} \ll W_{\text{Online}}$. We further note that if $N, K \ll \mathcal{N}$ then $W_{\text{Online}} \ll W_{\text{FE}} \equiv JM(O(\mathcal{N}))$, where W_{FE} is the operation count for standard FE evaluation of the MC sums. Hence the interest in the RB approach.

We make two final observations. First, a “con”: as we consider less smooth covariance functions with less rapidly decaying spectra not only — for a fixed desired accuracy — will K increase, but also N will increase (due to the more extended domain Λ_K^y). Clearly for sufficiently non-smooth covariances the RB approach will no longer be competitive. Second, a “pro”: the *a posteriori* error bounds will permit us to choose N and K minimally — for minimum computational effort — without sacrificing accuracy and certainty.

3.5 Numerical Results

In this section, we present numerical results for the model problem described in Section 3.1. We shall consider $G(x) \equiv 1$ and a finite-rank covariance kernel $\mathbf{Cov}_{\mathbf{P}}(\text{Bi})(x, y)$

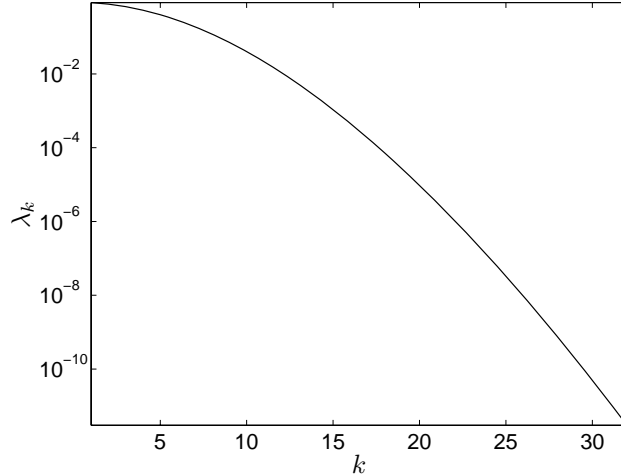

Figure 2: The eigenvalues λ_k as a function of k .

that coincides with $(\overline{\text{Bi}}\Upsilon)^2 e^{-\frac{(x-y)^2}{\delta^2}}$, $\delta = 0.5$ for the first $\mathcal{K} = 25$ terms in the KL expansion. (Recall that the length of Γ_B is 4, and hence δ is reasonably “small.” We shall subsequently consider even smaller δ .) We indeed limit the rank to $1 \leq K \leq \mathcal{K} = 25$ by *a priori* choice of \mathcal{K} such that the error due to the KL truncation at the continuous level is sufficiently small for $K = \mathcal{K}$. We use a regular mesh with quadratic elements and $\mathcal{N} = 6,882$ degrees of freedom for the “truth” FE approximation.

We calculate the eigenvalues and eigenvectors of $\mathbf{Cov}_{\mathbf{P}}(x, y)$ using the standard (Matlab®) Arpack routines. We subsequently calculate $\tau_0 = \frac{1}{2}$ and hence obtain from (28) the requirement $\Upsilon \leq \Upsilon_{\max} \equiv 0.037$; in our numerical examples we choose $\Upsilon = \Upsilon_{\max}$. We first present in Figure 2 the eigenvalues λ_k as a function of k ; we observe that the eigenvalues decay exponentially with respect to k^2 , which is in good agreement with theoretical bounds [32]. (Recall that, due to our scaling, the λ_k are in fact associated with a covariance function $e^{-\frac{(x-y)^2}{\delta^2}}$.) Figure 3 shows four random realizations of the Biot number $\text{Bi}(x, y)$ for $\overline{\text{Bi}} = 0.5$, while Figure 4 shows the corresponding temperature fields $u_{\mathcal{N}, K}(\mu_i)$, $1 \leq i \leq 4$, for $K = \mathcal{K}$.

We now turn to the RB approximation. We present in Figure 5 the eight leading basis functions ζ_n , $n = 1, 2, \dots, 8$; the maximum number of basis functions is $N_{\max} = 18$. These basis functions are obtained by pursuing the Greedy sampling procedure over a training set Ξ_{train} of $n_{\text{train}} = 10,000$ parameter points randomly selected with uniform law in the parameter space Λ^μ . Note $n_{\text{train}} = 10,000$ is arguably adequate given the rapid decay of the eigenvalues; in any event, our *a posteriori* error bounds will certify (in the Online stage) the accuracy of our RB predictions. The Greedy procedure terminates when the maximum error bound $\Delta_{N, \mathcal{K}, \max} = \max_{\mu \in \Xi_{\text{train}}} \Delta_{N, \mathcal{K}}(\mu)$ is less than 5×10^{-3} .

We now consider the statistical outputs; we choose $M = 10,000$ for our Monte-Carlo sums. We show in Table 1 the expected value and associated error bound for the integrated temperature at the bottom surface of the fin as a function of N and

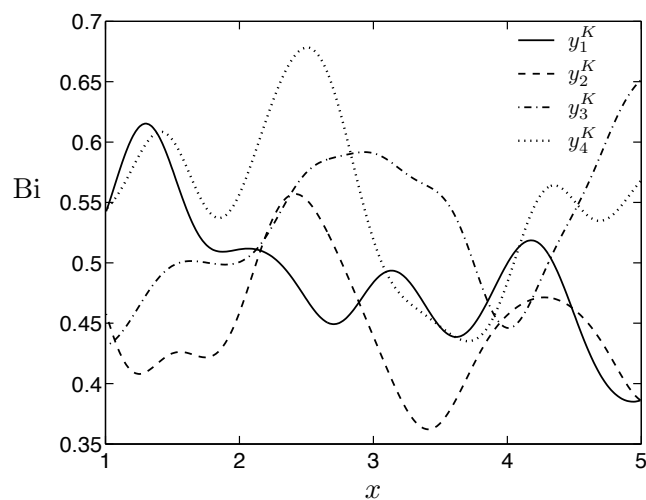

Figure 3: Four random realizations of the Biot number $\text{Bi}(x, y^K)$, $y^K = y_i^K$, $1 \leq i \leq 4$, for $\overline{\text{Bi}} = 0.5$.

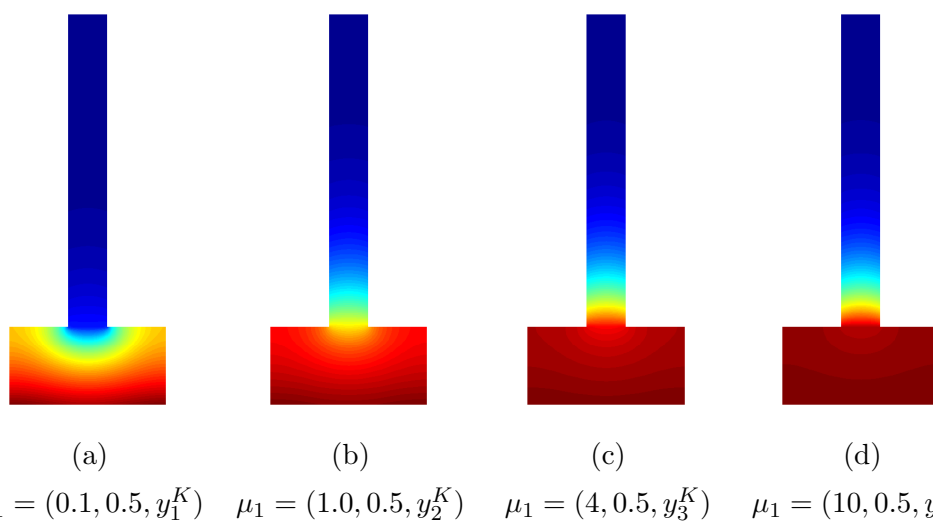

Figure 4: The temperature field $u_{\mathcal{N},K}(\mu_i)$, $1 \leq i \leq 4$, for $K = \mathcal{K}$. The Bi profile for the four random realizations y_i , $1 \leq i \leq 4$, are shown in Figure 3. We choose different κ and $\overline{\text{Bi}}$ for the four realizations.

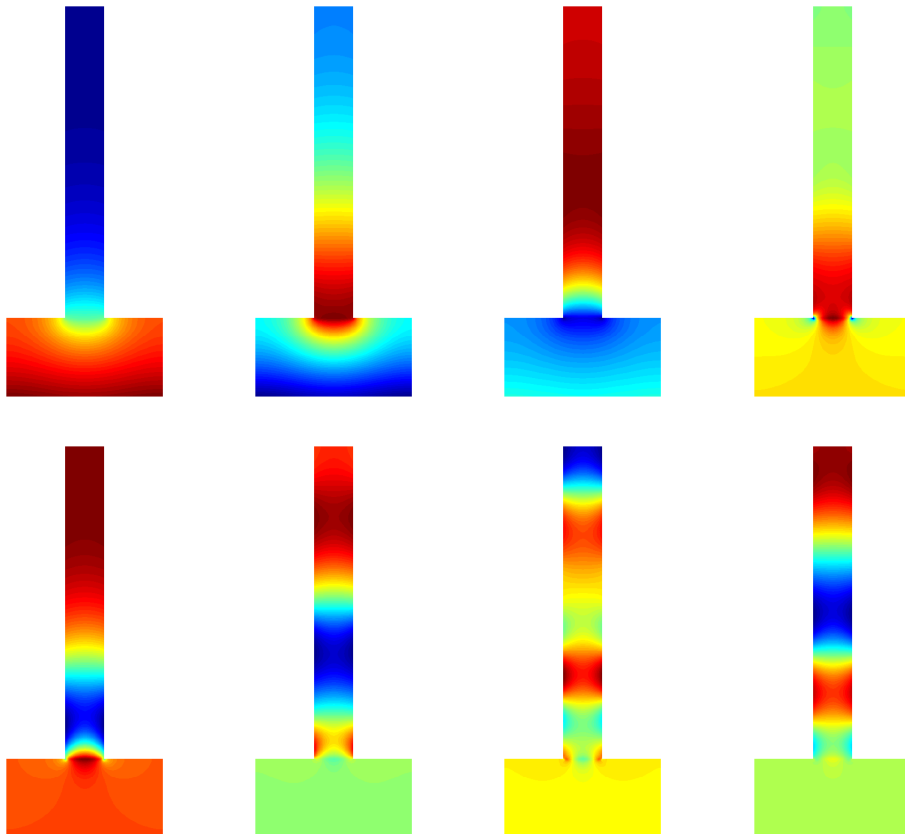

Figure 5: The eight leading RB basis functions ζ_n , $n = 1, 2, \dots, 8$. The basis functions are ordered from left to right and top to bottom as successively chosen (and orthonormalized) by the Greedy sampling procedure.

N	$K = 5$		$K = 10$		$K = 15$		$K = 20$	
	$E_M[s_{N,K}]$	$\Delta_E^o[s_{N,K}]$	$E_M[s_{N,K}]$	$\Delta_E^o[s_{N,K}]$	$E_M[s_{N,K}]$	$\Delta_E^o[s_{N,K}]$	$E_M[s_{N,K}]$	$\Delta_E^o[s_{N,K}]$
2	3.2602	4.74×10^0	3.2599	2.23×10^0	3.2600	1.59×10^0	3.2600	1.51×10^0
4	3.6920	2.20×10^0	3.6947	5.08×10^{-1}	3.6941	7.18×10^{-2}	3.6942	1.60×10^{-2}
6	3.6972	2.09×10^0	3.6974	4.76×10^{-1}	3.6979	5.80×10^{-2}	3.6966	4.54×10^{-3}
8	3.6981	2.09×10^0	3.6975	4.74×10^{-1}	3.6969	5.77×10^{-2}	3.6986	4.33×10^{-3}
10	3.6974	2.08×10^0	3.6977	4.71×10^{-1}	3.6976	5.69×10^{-2}	3.6978	3.94×10^{-3}
12	3.6973	2.07×10^0	3.6976	4.70×10^{-1}	3.6981	5.68×10^{-2}	3.6976	3.90×10^{-3}
14	3.6975	2.07×10^0	3.6974	4.70×10^{-1}	3.6977	5.68×10^{-2}	3.6978	3.89×10^{-3}

Table 1: Expected value $E_M[s_{N,K}](\kappa = 2.0, \bar{\text{Bi}} = 0.5)$ and error bound $\Delta_E^o[s_{N,K}](\kappa = 2.0, \bar{\text{Bi}} = 0.5)$ for different values of the RB dimension N and of the KL truncation order K .

N	$K = 5$		$K = 10$		$K = 15$		$K = 20$	
	$V_M[s_{N,K}]$	$\Delta_V^o[s_{N,K}]$	$V_M[s_{N,K}]$	$\Delta_V^o[s_{N,K}]$	$v_M[s_{N,K}]$	$\Delta_V^o[s_{N,K}]$	$V_M[s_{N,K}]$	$\Delta_V^o[s_{N,K}]$
2	0.0039	9.38×10^{-1}	0.0041	4.38×10^{-1}	0.0041	3.23×10^{-1}	0.0041	3.00×10^{-1}
4	0.0039	4.54×10^{-1}	0.0045	1.11×10^{-1}	0.0045	1.56×10^{-2}	0.0045	3.52×10^{-3}
6	0.0037	4.05×10^{-1}	0.0043	1.02×10^{-1}	0.0043	1.23×10^{-2}	0.0043	9.89×10^{-4}
8	0.0037	4.05×10^{-1}	0.0043	1.08×10^{-1}	0.0043	1.26×10^{-2}	0.0043	9.09×10^{-4}
10	0.0038	4.16×10^{-1}	0.0043	9.72×10^{-2}	0.0043	1.24×10^{-2}	0.0043	8.32×10^{-4}
12	0.0038	4.16×10^{-1}	0.0043	9.72×10^{-2}	0.0043	1.24×10^{-2}	0.0043	8.36×10^{-4}
14	0.0038	4.12×10^{-1}	0.0043	9.72×10^{-2}	0.0043	1.23×10^{-2}	0.0043	8.46×10^{-4}

Table 2: Variance $V_M[s_{N,K}](\kappa = 2.0, \bar{\text{Bi}} = 0.5)$ and error bound $\Delta_V^o[s_{N,K}](\kappa = 2.0, \bar{\text{Bi}} = 0.5)$ for different values of the RB dimension N and of the KL truncation order K .

K for $\kappa = 2.0$ and $\bar{\text{Bi}} = 0.5$. Table 2 displays the corresponding variance and associated error bound. Figures 6(a) and 6(b) show the error bounds for the expected value and variance, respectively. We observe that the error bounds, $\Delta_E^o[s_{N,K}](2.0, 0.5)$ and $\Delta_V^o[s_{N,K}](2.0, 0.5)$, depend on N and K in a strongly coupled manner: for a fixed value of K the error bounds initially decrease with increasing N and then level off for N large; when the error bounds no longer improve with increasing N , increasing K further reduces the error. This behavior of the error bounds is expected since the accuracy of our predictions is limited by both the RB error bound $\Delta_{N,K}^s(\mu)$ and the KL truncation error bound $\Delta_{N,K}^t(\mu)$: the former decreases rapidly with increasing N only while the latter decreases rapidly with increasing K only. We note that the KL truncation error bounds, $\Delta_E^t[s_{N,K}](2.0, 0.5)$ and $\Delta_V^t[s_{N,K}](2.0, 0.5)$, dominate the RB error bounds, $\Delta_E^s[s_{N,K}](2.0, 0.5)$ and $\Delta_V^s[s_{N,K}](2.0, 0.5)$, respectively, as shown in Figures 7 and 8.

Nevertheless, the expectation and variance error bounds (and the actual errors) decrease very rapidly as both N and K increase. Such a rapid convergence is expected because the solution is very smooth with respect to the Biot number Bi and also because the eigenvalues decay rapidly. For $N = 10$ and $K = 20$ the error bounds for the expected

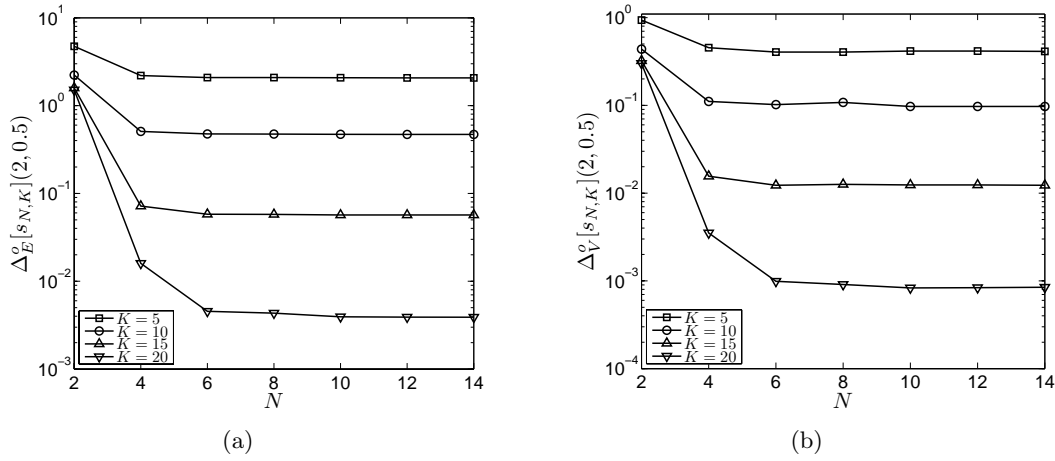

Figure 6: (a) $\Delta_E^o[s_{N,K}](\kappa, \overline{\text{Bi}})$ and (b) $\Delta_V^o[s_{N,K}](\kappa, \overline{\text{Bi}})$ as a function of N and K for $\kappa = 2.0$ and $\overline{\text{Bi}} = 0.5$.

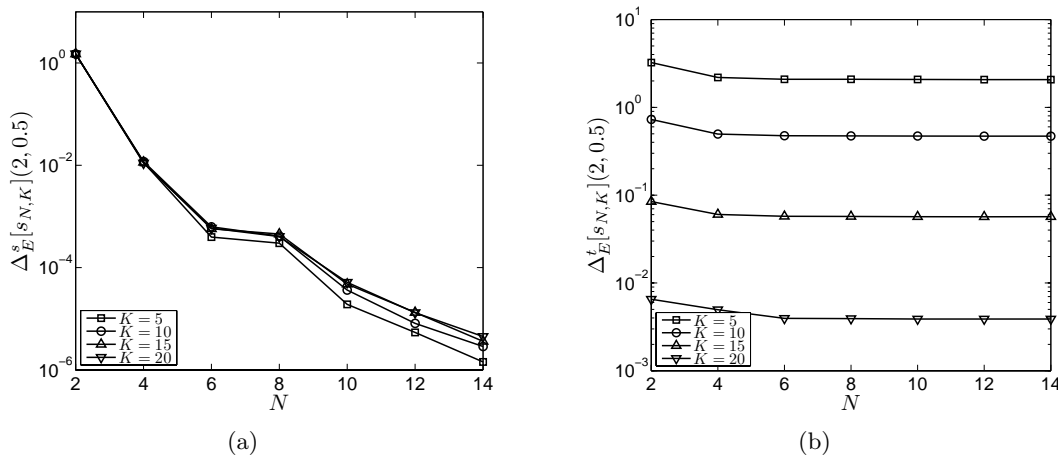

Figure 7: (a) $\Delta_E^s[s_{N,K}](\kappa, \overline{\text{Bi}})$ and (b) $\Delta_E^t[s_{N,K}](\kappa, \overline{\text{Bi}})$ as a function of N and K for $\kappa = 2.0$ and $\overline{\text{Bi}} = 0.5$.

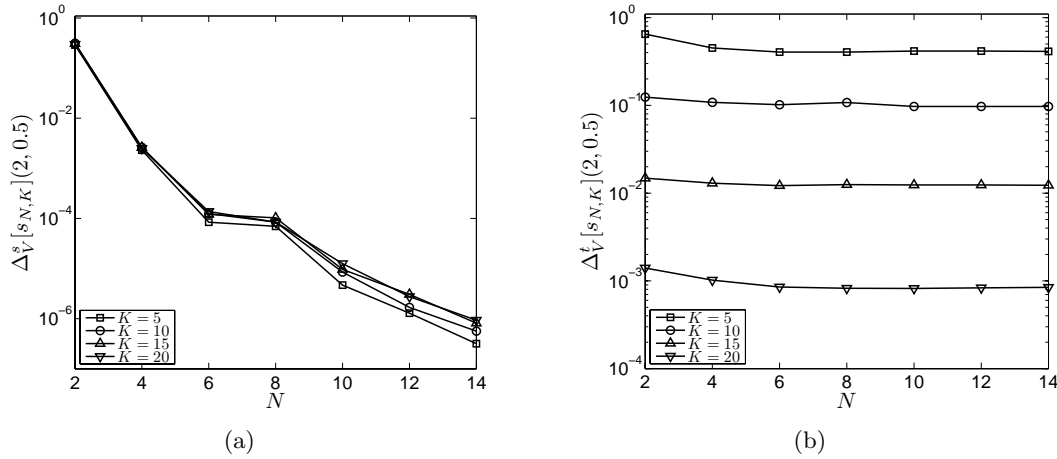

Figure 8: (a) $\Delta_V^s[s_{N,K}](\kappa, \overline{\text{Bi}})$ and (b) $\Delta_V^t[s_{N,K}](\kappa, \overline{\text{Bi}})$ as a function of N and K for $\kappa = 2.0$ and $\overline{\text{Bi}} = 0.5$.

value and variance are 3.94×10^{-3} (0.1%) and 8.32×10^{-4} (20%), respectively, while the RB computational savings (including both Offline and Online effort) relative to the FE method is more than a factor of $\frac{1}{45}$; in the limit J (many $(\kappa, \overline{\text{Bi}})$ queries) $\rightarrow \infty$ or $M \rightarrow \infty$, the RB savings will approach $\frac{1}{200}$ — which reflects just the Online effort. The $N = 10, K = 20$ statistical results can be obtained Online in only 70 seconds (for a given $(\kappa, \overline{\text{Bi}})$) on a Pentium IV 1.73 GHz; it would take roughly 4 hours for the FE method to perform the same calculation.

We present in Figure 9 the expected value and variance as a function of M for the same parameter value $\kappa = 2.0$ and $\overline{\text{Bi}} = 0.5$; these results are obtained for $N = 10$ and $K = 20$. (Note that we do not need to repeat the Offline stage for different M .) We show in Figure 10 the expected value of the integrated temperature at the bottom surface of the heat sink as a function of κ and $\overline{\text{Bi}}$; the results are plotted in Figure 10(a) for $M = 5,000$ and in Figure 10(b) for $M = 10,000$. Here the statistical outputs are obtained for $N = 10$ and $K = 20$ and for 15×15 grid points in the parameter space; the maximum relative error in the expectation over the 225 parameter grid points is 9.4×10^{-4} . (The results in Figure 10(a) and 10(b) each require $J = 225$ Monte-Carlo sums.)

We see that for $\kappa = 2.0$ and $\overline{\text{Bi}} = 0.5$, the standard deviation of the integrated temperature is less than 2% of the expected integrated temperature; we can conclude that, for this value of κ and $\overline{\text{Bi}}$, uncertainties in Bi are not too important to “device performance.” However, for larger κ and small $\overline{\text{Bi}}$ we expect more sensitivity: we find that for $\kappa = 10$ and $\overline{\text{Bi}} = 0.1$ the standard deviation of the integrated temperature is now 6% of the expected integrated temperature — and hence of engineering relevance. It is also possible to calculate the empirical cumulative distribution function to both assess the range and likelihood of “tails.”

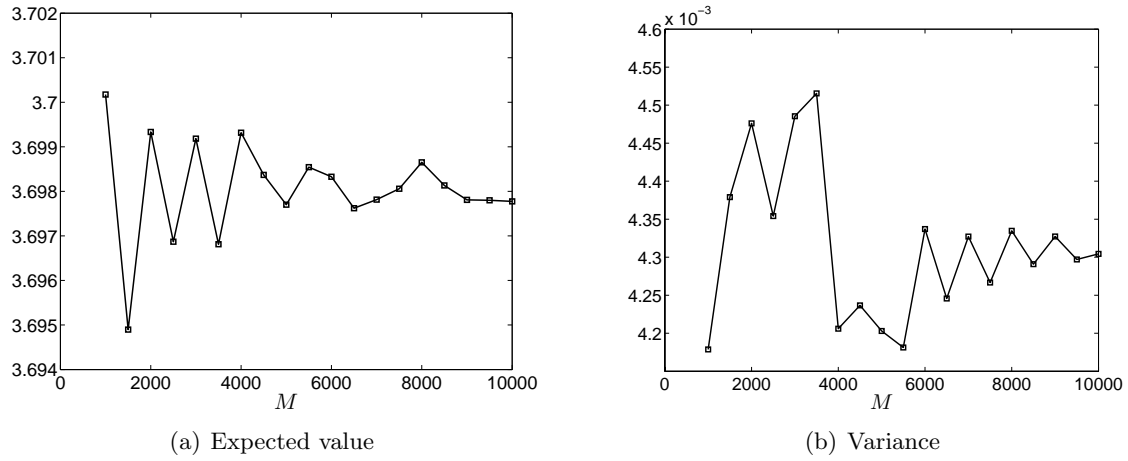

Figure 9: Expected value $E_M[s_{N,K}](2.0, 0.5)$ and variance $V_M[s_{N,K}](2.0, 0.5)$ for the output as a function of M .

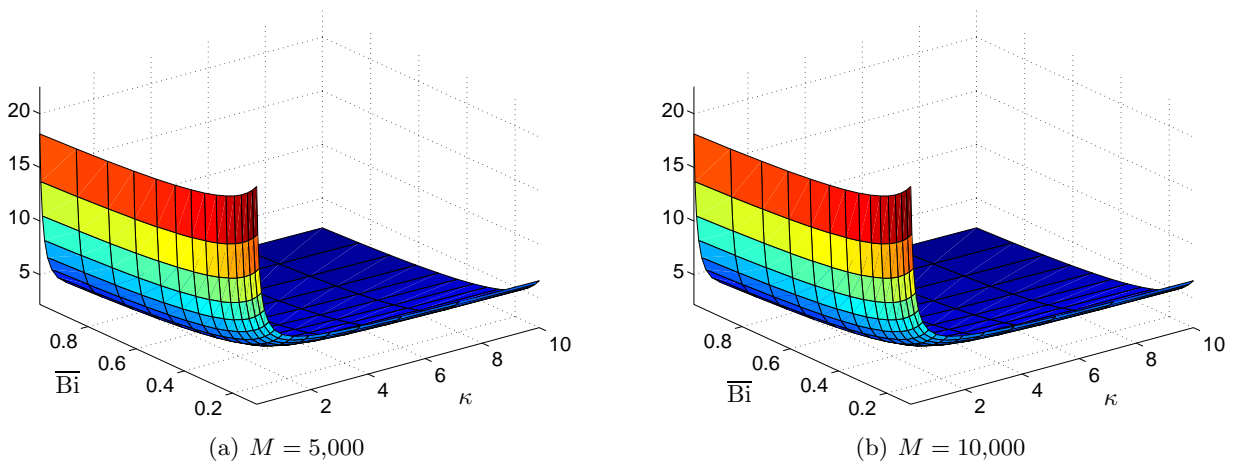

Figure 10: Expected value of the integrated temperature at the bottom surface of the fin as a function of κ and $\overline{\text{Bi}}$ over $\Lambda^e \equiv [0.1, 10] \times [0.1, 1]$.

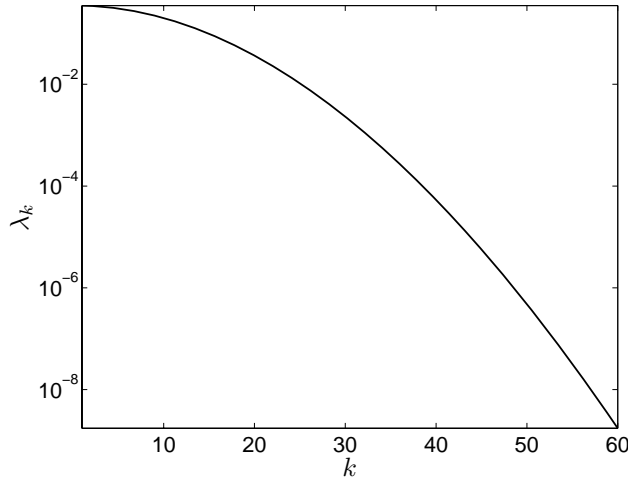

Figure 11: The eigenvalue λ_k as a function of k for the correlation length $\delta = 0.2$.

Finally, we consider a Gaussian covariance $(\overline{\text{Bi}}\Upsilon)^2 e^{-\frac{(x-y)^2}{\delta^2}}$, $\delta = 0.2$, corresponding to a smaller correlation length. We present in Figure 11 the eigenvalues λ_k as a function of k . We see that the eigenvalue decays at a slower rate than the previous case (shown in Figure 2). Figure 12 shows four random realizations of the Biot number $\text{Bi}(x, y)$; these four random realizations vary more rapidly in space than the earlier instances of Figure 3. We then pursue the greedy sampling procedure for $\mathcal{K} = 60$ (*a priori* determined) to construct the nested basis sets X_N , $1 \leq N \leq N_{\max}$; we obtain $N_{\max} = 32$ — it is not surprising from the Figures 11 and 12 that the RB method needs larger N_{\max} as the correlation length δ decreases.

We show in Table 3 the expected value and associated error bound for the integrated temperature at the bottom surface of the heat sink as a function of N and K for $\kappa = 2.0$ and $\overline{\text{Bi}} = 0.5$.⁶ Table 4 displays the corresponding variance and associated error bound. Figure 13 shows the error bounds for the expected value and variance. We see that while the convergence pattern is similar to that of the previous case ($\delta = 0.5$), we need to use larger N and K to obtain the same accuracy for $\delta = 0.2$. Nevertheless, the reduction in computational time is still quite significant: for $N = 10$ and $K = 45$ (for which the ratio $\Delta_E[s_{N,K}](\kappa = 2.0, \overline{\text{Bi}} = 0.5)/E_M[s_{N,K}](\kappa = 2.0, \overline{\text{Bi}} = 0.5)$ is less than 0.01) the Online RB evaluation is still more than 50 times faster than the FE evaluation. Obviously, when the correlation length decreases further and further, the RB approach will no longer offer significant economies or may even become more expensive than the FE method; note however that, in three spatial dimensions, the RB method can “afford” a smaller correlation length since the FE truth will be considerably more expensive.

⁶The values for $\delta = 0.2$ are very similar to the values for $\delta = 0.5$ for the same reason that the variance is in general small: the output is relatively insensitive to Bi fluctuations.

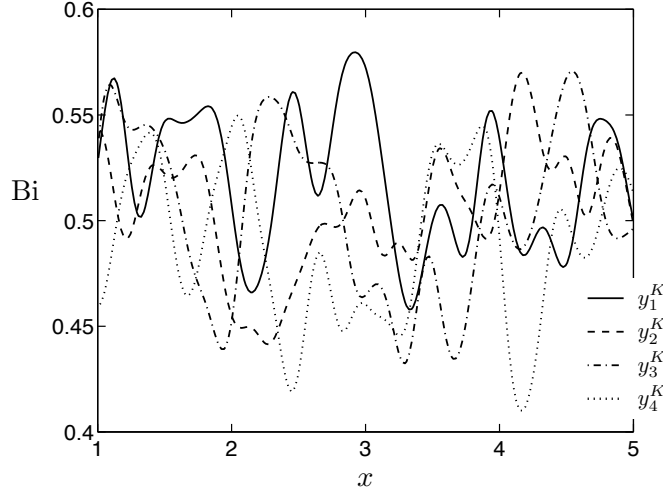

Figure 12: Four random realizations of the Biot number $\text{Bi}(x, y^K)$, $y^K = y_i^K, 1 \leq i \leq 4$, for the correlation length $\delta = 0.2$.

N	$K = 15$		$K = 30$		$K = 45$		$K = 60$	
	$E_M[s_{N,K}]$	$\Delta_E^o[s_{N,K}]$	$E_M[s_{N,K}]$	$\Delta_E^o[s_{N,K}]$	$E_M[s_{N,K}]$	$\Delta_E^o[s_{N,K}]$	$E_M[s_{N,K}]$	$\Delta_E^o[s_{N,K}]$
5	3.6975	4.09×10^0	3.6970	4.80×10^{-1}	3.6960	1.55×10^{-2}	3.6960	2.68×10^{-3}
10	3.6975	4.03×10^0	3.6973	4.71×10^{-1}	3.6979	1.34×10^{-2}	3.6963	7.62×10^{-4}
15	3.6973	4.02×10^0	3.6978	4.70×10^{-1}	3.6970	1.32×10^{-2}	3.6977	6.05×10^{-4}
20	3.6980	4.00×10^0	3.6980	4.67×10^{-1}	3.6973	1.29×10^{-2}	3.6980	3.65×10^{-4}
25	3.6969	3.99×10^0	3.6977	4.66×10^{-1}	3.6972	1.28×10^{-2}	3.6981	3.36×10^{-4}
30	3.6968	3.99×10^0	3.6975	4.66×10^{-1}	3.6972	1.28×10^{-2}	3.6975	3.30×10^{-4}

Table 3: Expected value $E_M[s_{N,K}](\kappa = 2.0, \bar{\text{Bi}} = 0.5)$ and error bound $\Delta_E[s_{N,K}](\kappa = 2.0, \bar{\text{Bi}} = 0.5)$ for different values of N and K for the correlation length $\delta = 0.2$.

N	$K = 15$		$K = 30$		$K = 45$		$K = 60$	
	$V_M[s_{N,K}]$	$\Delta_V^o[s_{N,K}]$	$V_M[s_{N,K}]$	$\Delta_V^o[s_{N,K}]$	$v_M[s_{N,K}]$	$\Delta_V^o[s_{N,K}]$	$V_M[s_{N,K}]$	$\Delta_V^o[s_{N,K}]$
5	0.0038	8.09×10^{-1}	0.0039	9.64×10^{-2}	0.0039	3.15×10^{-3}	0.0038	5.41×10^{-4}
10	0.0039	8.04×10^{-1}	0.0039	9.36×10^{-2}	0.0039	2.68×10^{-3}	0.0039	1.53×10^{-4}
15	0.0040	8.07×10^{-1}	0.0039	9.50×10^{-2}	0.0040	2.67×10^{-3}	0.0039	1.21×10^{-4}
20	0.0039	7.99×10^{-1}	0.0039	9.39×10^{-2}	0.0040	2.57×10^{-3}	0.0039	7.28×10^{-5}
25	0.0039	8.02×10^{-1}	0.0039	9.28×10^{-2}	0.0040	2.62×10^{-3}	0.0040	6.76×10^{-5}
30	0.0039	7.84×10^{-1}	0.0040	9.39×10^{-2}	0.0040	2.58×10^{-3}	0.0040	6.71×10^{-5}

Table 4: Variance $V_M[s_{N,K}](\kappa = 2.0, \bar{\text{Bi}} = 0.5)$ and error bound $\Delta_V[s_{N,K}](\kappa = 2.0, \bar{\text{Bi}} = 0.5)$ for different values of N and K for the correlation length $\delta = 0.2$.

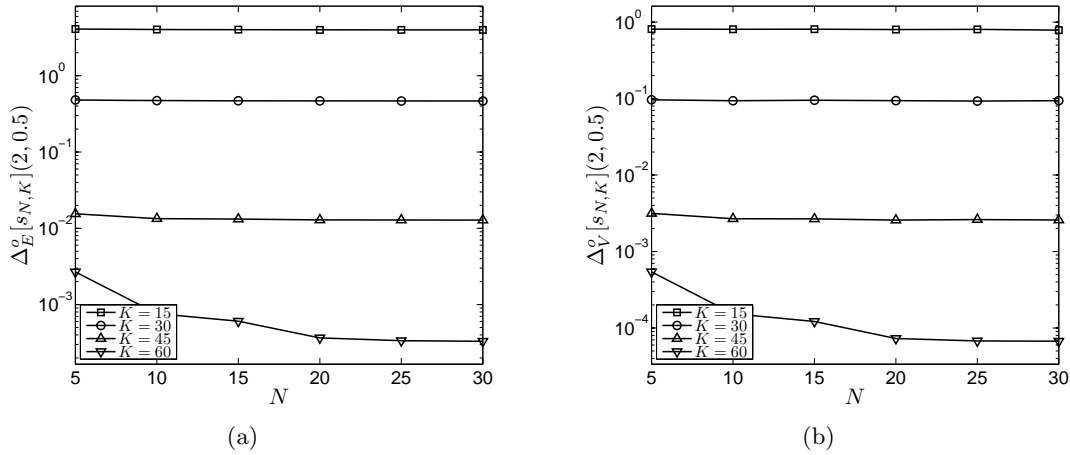

Figure 13: (a) $\Delta_E^o[s_{N,K}](\kappa, \bar{\mathbf{b}})$ and (b) $\Delta_V^o[s_{N,K}](\kappa, \bar{\mathbf{b}})$ as a function of N and K for $\kappa = 2.0$ and $\bar{\mathbf{b}} = 0.5$ for the correlation length $\delta = 0.2$.

4 Conclusions

In this article we have developed the theoretical framework (error bounds) for, and numerically demonstrated the attractiveness of, an RB approach for the rapid and reliable computation of expectations of linear functionals of variational solutions to a BVP with ω - x “separable” random parameter fields. The *a posteriori* error bounds certify the quality of the approximation and quantify the effects of both the FE \rightarrow RB reduction for the BVP and the KL truncation in the random field expansion. The method also permits the study of the parametric dependence of the outputs with respect to other (deterministic) parameters entering the problem.

Future developments may include:

- (a) test problems in which the stochastic element multiplies the solution field not only on the boundary but also over the entire domain,
- (b) more general random variates (and sampling procedures) in the KL expansion of the stochastic input field,
- (c) inputs developed with expansions other than KL (not necessarily decoupling \mathcal{D} and Ω , and thus requiring empirical interpolation [4, 15]),
- (d) more general statistical outputs (that remain sufficiently smooth functionals of the random solution field — continuous in $L_{\mathbf{P}}^p(\Omega, H^1(\mathcal{D}))$), and
- (e) application of the RB approach to Ω -weak/ \mathcal{D} -weak collocation formulations [2, 26].

But from our first results, it is arguably already interesting to apply an RB approach within many of the Ω -strong/ \mathcal{D} -weak formulations in view of the simplicity of the implementation, the considerable reduction in computational time, and the availability of

rigorous error bounds (suitably generalized, in particular as regards the contribution of the KL truncation and associated continuity constants).

Acknowledgments

We thank Dr. Gianluigi Rozza of EPFL for helpful discussions. This work was supported by AFOSR Grant FA9550-07-1-0425, the Singapore-MIT Alliance, and the Chaire d'excellence ACI "Application des polynômes de chaos à la modélisation des incertitudes en mécanique des fluides."

References

- [1] B.O. Almroth, P. Stern, and F.A. Brogan. Automatic choice of global shape functions in structural analysis. *AIAA Journal*, 16:525–528, 1978.
- [2] I. Babuška, F. Nobile, and R. Tempone. A stochastic collocation method for elliptic partial differential equations with random input data. *SIAM Journal on Numerical Analysis*, 45(3):1005–1034, 2007.
- [3] I. Babuška, R. Tempone, and G. Zouraris. Solving elliptic boundary value problems with uncertain coefficients by the finite element method: the stochastic formulation. *Comput. Meth. Appl. Mech. Eng.*, 194:1251–1294, 2005.
- [4] M. Barrault, Y. Maday, N.C. Nguyen, and A.T. Patera. An "empirical interpolation" method; Application to efficient reduced-basis discretization of partial differential equations. *C.R. Acad. Sci. Paris*, 339:667–672, 2004.
- [5] X. Blanc, C. Le Bris, and P.L. Lions. Une variante de la théorie de l'homogénéisation stochastique des opérateurs elliptiques. *C.R. Acad. Sci. Paris*, 343(11–12):717–724, 2006.
- [6] S. Boyaval. Reduced-basis approach for homogenization beyond the periodic setting. *SIAM Multiscale Modeling & Simulation*, 7(1):466–494, 2008.
- [7] Y. Chen, J. Hesthaven, Y. Maday, and J. Rodríguez. A monotonic evaluation of lower bounds for inf-sup stability constants in the frame of reduced basis approximations. *C.R. Math. Acad. Sci. Paris*, 2008, submitted.
- [8] D.B. Chung, M.A. Gutiérrez, J.J.C. Remmers, and R. de Borst. Stochastic finite element modelling of fibre-metal laminates. In *45th AIAA/ASME/ASCE/AHS/ASC Structures, Structural Dynamics & Materials Conference*, April 2004.
- [9] M.K. Deb, I.M. Babuška, and J.T. Oden. Solution of stochastic partial differential equations using galerkin finite element techniques. *Comp. Meth. Appl. Mech. Engrg.*, 190(48):6359–6372, 2001.

-
- [10] B.J. Debuschere, H.N. Najm, P.P. Pebay, O.M. Knio, R.G. Ghanem, and O.P.L. Maitre. Numerical challenges in the use of polynomial chaos representations for stochastic processes. *SIAM on Journal on Scientific Computing*, 26(2):698–719, 2004.
- [11] J.P. Fink and W.C. Rheinboldt. On the error behavior of the reduced basis technique for nonlinear finite element approximations. *Z. Angew. Math. Mech.*, 63(1):21–28, 1983.
- [12] P. Frauenfelder, C. Schwab, and R.A. Todor. Deterministic FEM for elliptic problems with stochastic coefficients. *Comput. Meth. Appl. Mech. Eng.*, 194:205–228, 2005.
- [13] R. Ghanem and S. Dham. Stochastic finite element analysis for multiphase flow in heterogeneous porous media. *Transp. Porous Media*, 32(239), 1998.
- [14] R.G. Ghanem and P.D. Spanos. *Stochastic finite elements: A spectral approach*. Springer Verlag, New York, 1991. Revised First Dover Edition, 2003.
- [15] M.A. Grepl, Y. Maday, N.C. Nguyen, and A.T. Patera. Efficient approximation for reduced-basis treatment of nonaffine and nonlinear partial differential equations. *Mathematical Modelling and Numerical Analysis (M2AN)*, 41:575–605, 2007.
- [16] D.B.P. Huynh, G. Rozza, S. Sen, and A.T. Patera. A successive constraint linear optimization method for lower bounds of parametric coercivity and inf-sup stability constants. *C.R. Acad. Sci. Paris, Analyse Numérique*, 345(8):473–478, 2007. (doi: 10.1016/j.crma.2007.09.019).
- [17] J.H. Lienhard IV and J.H. Lienhard V. *A Heat Transfer Textbook*. Phlogiston Press, Cambridge, Mass., 2002.
- [18] M. Jardak and R. Ghanem. Spectral stochastic homogenization for of divergence-type PDEs. *Computer Methods in Applied Mechanics and Engineering*, 193:429–447, 2004.
- [19] A. Keese and H.G. Matthies. Hierarchical parallelisation for the solution of stochastic finite element equations. *Computers & Structures*, 83(14):1033–1047, 2005.
- [20] M. Loève. *Probability Theory*, volume I-II. Springer, New York, 1978.
- [21] L. Machiels, Y. Maday, I. B. Oliveira, A.T. Patera, and D.V. Rovas. Output bounds for reduced-basis approximations of symmetric positive definite eigenvalue problems. *C. R. Acad. Sci. Paris, Série I*, 331(2):153–158, 2000.
- [22] L. Mathelin, M.Y. Hussaini, and T.A. Zang. Stochastic approaches to uncertainty quantification in CFD simulations. *Numerical Algorithms*, 38:209–236, 2005.
- [23] H.G. Matthies and A. Keese. Galerkin methods for linear and nonlinear elliptic stochastic pdes. *Comput. Meth. Appl. Mech. Eng.*, 194:1295–1331, 2005.

-
- [24] P. B. Nair and A. J. Keane. Stochastic reduced basis methods. *AIAA Journal*, 40(8):1653–1664, 2002.
- [25] N.C. Nguyen, K. Veroy, and A.T. Patera. Certified real-time solution of parametrized partial differential equations. In S. Yip, editor, *Handbook of Materials Modeling*, pages 1523–1558. Springer, 2005.
- [26] F. Nobile, R. Tempone, and C. Webster. A sparse grid stochastic collocation method for partial differential equations with random input data. *SIAM J. Numer. Anal.*, 46:2309–2345, 2008.
- [27] A.K. Noor and J.M. Peters. Reduced basis technique for nonlinear analysis of structures. *AIAA Journal*, 18(4):455–462, 1980.
- [28] T.A. Porsching. Estimation of the error in the reduced basis method solution of nonlinear equations. *Mathematics of Computation*, 45(172):487–496, 1985.
- [29] C. Prud’homme, D. Rovas, K. Veroy, Y. Maday, A.T. Patera, and G. Turinici. Reliable real-time solution of parametrized partial differential equations: Reduced-basis output bounds methods. *Journal of Fluids Engineering*, 124(1):70–80, 2002.
- [30] G. Rozza, D.B.P. Huynh, and A.T. Patera. Reduced basis approximation and *a posteriori* error estimation for affinely parametrized elliptic coercive partial differential equations; Application to transport and continuum mechanics. *Arch Comput Methods Eng*, 2008 (to appear). doi: 10.1007/s11831-008-9019-9.
- [31] S.K. Sachdeva, P.B. Nair, and A.J. Keane. Hybridization of stochastic reduced basis methods with polynomial chaos expansions. *Probabilistic Engineering Mechanics*, 21:182–192, 2006.
- [32] C. Schwab and R.A. Todor. Karhunen-Loève approximation of random fields by generalized fast multipole methods. *Journal of Computational Physics*, 217(1):100–122, 2006.
- [33] B. Sudret, M. Berveiller, and M. Lemaire. A stochastic finite element procedure for moment and reliability analysis. *Rev. Eur. Méca. Num.*, 15(7-8):825–866, 2006.
- [34] R.A. Todor and C. Schwab. Convergence rates for sparse chaos approximations of elliptic problems with stochastic coefficients. *IMA Journal of Numerical Analysis*, 27:232–261, 2007.
- [35] G. Venkiteswaran and M. Junk. Quasi-Monte-Carlo algorithms for diffusion equations in high dimensions. *Math. Comput. Simul.*, 68(1):23–41, 2005.
- [36] X. Wan and G.E. Karniadakis. An adaptive multi-element generalized polynomial chaos method for stochastic differential equations. *Journal of Computational Physics*, 209:617–642, 2005.

-
- [37] X. Wan and G.E. Karniadakis. Error control in multi-element generalized polynomial chaos method for elliptic problems with random coefficients. *Communications in Computational Physics*, 5(2–4):793–820, 2009. Available online 1 August 2008.
- [38] N. Wiener. The homogeneous chaos. *Am. J. Math.*, 60:897–936, 1938.
- [39] D. Xiu and G.E. Karniadakis. The Wiener-Askey polynomial chaos for stochastic differential equations. *SIAM on Journal on Scientific Computing*, 24:619–644, 2002.



Unité de recherche INRIA Rocquencourt
Domaine de Voluceau - Rocquencourt - BP 105 - 78153 Le Chesnay Cedex (France)

Unité de recherche INRIA Futurs : Parc Club Orsay Université - ZAC des Vignes
4, rue Jacques Monod - 91893 ORSAY Cedex (France)

Unité de recherche INRIA Lorraine : LORIA, Technopôle de Nancy-Brabois - Campus scientifique
615, rue du Jardin Botanique - BP 101 - 54602 Villers-lès-Nancy Cedex (France)

Unité de recherche INRIA Rennes : IRISA, Campus universitaire de Beaulieu - 35042 Rennes Cedex (France)

Unité de recherche INRIA Rhône-Alpes : 655, avenue de l'Europe - 38334 Montbonnot Saint-Ismier (France)

Unité de recherche INRIA Sophia Antipolis : 2004, route des Lucioles - BP 93 - 06902 Sophia Antipolis Cedex (France)

Éditeur
INRIA - Domaine de Voluceau - Rocquencourt, BP 105 - 78153 Le Chesnay Cedex (France)
<http://www.inria.fr>
ISSN 0249-6399