



A Multi-Burst Sliding Encoding for Mobile Satellite TV Broadcasting

Mohamed Amine Ismail, Walid Dabbous, Antoine Clerget

► **To cite this version:**

Mohamed Amine Ismail, Walid Dabbous, Antoine Clerget. A Multi-Burst Sliding Encoding for Mobile Satellite TV Broadcasting. 2008. inria-00349223v2

HAL Id: inria-00349223

<https://hal.inria.fr/inria-00349223v2>

Submitted on 9 Jan 2009

HAL is a multi-disciplinary open access archive for the deposit and dissemination of scientific research documents, whether they are published or not. The documents may come from teaching and research institutions in France or abroad, or from public or private research centers.

L'archive ouverte pluridisciplinaire **HAL**, est destinée au dépôt et à la diffusion de documents scientifiques de niveau recherche, publiés ou non, émanant des établissements d'enseignement et de recherche français ou étrangers, des laboratoires publics ou privés.



INSTITUT NATIONAL DE RECHERCHE EN INFORMATIQUE ET EN AUTOMATIQUE

A Multi-Burst Sliding Encoding for Mobile Satellite TV Broadcasting

Mohamed Amine ISMAIL — Walid DABBOUS — Antoine CLERGET

N° 6785 — version 2

initial version December 2008 — revised version January 2009

Thème COM



*R*apport
de recherche

ISRN INRIA/RR--6785--FR+ENG

ISSN 0249-6399

A Multi-Burst Sliding Encoding for Mobile Satellite TV Broadcasting

Mohamed Amine ISMAIL*[†], Walid DABBOUS*, Antoine
CLERGET[†]

Thème COM — Systèmes communicants
Équipes-Projets Planete

Rapport de recherche n° 6785 — version 2 — initial version December 2008
— revised version January 2009 — 24 pages

Abstract: Protection of data against long fading time is one of the greatest challenges posed by a satellite delivery system offering multimedia services to mobile devices like DVB-SH. To deal with this challenge several enhancements and modifications of the existing terrestrial mobile TV (DVB-H) physical and link layers are being considered. These solutions provide the required protection depth but they don't take into account the specificity of mobile handheld devices such as power consumption, memory constraints and chipsets implementation costs. In this report, we propose an innovative algorithm (called Multi Burst Sliding Encoding or MBSE) that extends the DVB-H intra-burst (MPE-FEC) protection to an inter-burst protection so that complete burst losses could be recovered while taking into account the specificity of mobile handheld devices. Based on a clever organisation of the data, our algorithm allows to provide protection against long term fading while still using RS code implemented in DVB-H chipsets. We evaluate the performance of MBSE by both theoretical analysis as well as intensive simulations and experiments. The results also show good performance in terms of protection, battery and memory saving. The MBSE is now under standardisation and it is considered by the DVB Forum as the main solution for the DVB-SH class terminals.

Key-words: MBSE, DVB-SH, TU6, LMS, iFEC, Sliding Encoding

* INRIA Sophia Antipolis, Planete Team

[†] R&D Department of UDCast Sophia Antipolis

Un codage multi-rafale glissant pour la radiodiffusion de la télévision mobile par satellite

Résumé : La protection des données contre les évanouissements du signal de longue durée est l'un des plus grands défis posés par un système de diffusion de services multimédia vers des équipements mobiles par satellite tel que DVB-SH. Pour faire face à ce défi plusieurs améliorations et modifications de la couche physique et de la couche liaison du standard de diffusion de la télévision mobile terrestre (DVB-H) ont été examinées. Ces solutions fournissent la protection requise mais elles ne prennent pas en compte les spécifications des équipements portables tel que la consommation d'énergie, les contraintes sur la taille de la mémoire ainsi que les coûts d'implémentation des chipsets. Dans ce rapport on propose un algorithme innovant (appelé Codage Multi-rafale Glissant ou CMRG) qui étend la protection intra-rafale (MPE-FEC) de DVB-H à une protection inter-rafale permettant la récupération de rafales complètement perdues tout en prenant en compte les spécificités des équipements portables. Basé sur une organisation intelligente des données, notre algorithme offre une protection contre les évanouissements du signal de longue durée tout en utilisant le codage RS implémenté dans les chipsets DVB-H. Nous avons évalué les performances de CMRG aussi bien théoriquement que par des simulations et des expérimentations. Les résultats montrent de bonnes performances en terme de protection, d'économie d'énergie et de mémoire. CMRG est actuellement en cours de standardisation et il est considéré par le Forum DVB comme la solution principale pour les terminaux DVB-SH.

Mots-clés : CMRG, DVB-SH, TU6, LMS, iFEC, Codage Glissant

1 Introduction

Reliable video streaming over unreliable, bandwidth-constraint, unidirectional broadcast links for mobile users is a challenging task. Reliability in this environment is achieved using Forward Error Correction (FEC). FEC is accomplished by adding redundancy to the transmitted information using well known algorithms such as Reed Solomon [1], LDPC [2], Raptor [3], or others.

DVB-T [4], the digital terrestrial television standard, uses Orthogonal Frequency Division Multiplex (OFDM) as a modulation technique for its physical layer. In order to provide sufficient protection against errors caused by the transmission channel, series of concatenated encoding operations are applied to the incoming data. The input stream is passed through an outer coder (Reed Solomon encoder) and an inner coder (convolutional encoder) to generate some redundant data. Since the channel variations could fade the channel during a time longer than the duration of several OFDM symbols, an outer interleaver is placed between the outer and the inner coders. It achieves time diversity by spreading the bytes of up to 8 MPEG-2 transport packets [5]. Since the frequency selective transmission generally affects neighbor sub-carriers, an inner interleaver is placed after the inner coder and achieves frequency diversity by mapping the bits over distant subcarriers of the transmission frame. The DVB-T coding process is shown by the figure Fig.1

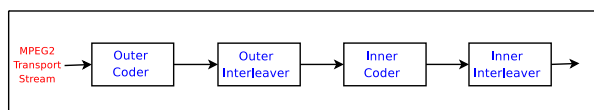

Figure 1: DVB-T Channel coding

The DVB-H [6] is the digital broadcast standard defining the way to broadcast “IP contents” to handheld devices. It is considered as the European solution to provide a good quality terrestrial mobile TV. DVB-H is based on DVB-T but takes into account the specific properties of typical handheld size terminals: limited battery capacity, mobile reception using small antenna with a low gain.

To solve the problem of the power consumption, a time division multiplex transmission is introduced at the link layer level. This technique is called Time-Slicing. The Time-Slicing is one of the innovations of DVB-H. The key idea is to transmit data in “bursts” exclusively carrying a single service. The data rate of the bursts is much higher compared to the average data rate of the service itself, typically a burst uses the whole channel rate during its transmission. This enables a time selective reception of the wanted service by switching to a power-save mode during the transmission of other services, unlike DVB-T where the whole data stream has to be decoded before one of the services can be extracted (Fig.2 and Fig.3). The Bursts contain the IP datagrams required to provide the service during the time of the burst and the off-time. By buffering within the terminal, it is ensured that the replay of the service is continuous and that the user does not perceive the burst nature of the data flow. Depending on the on-time over off-time ratio the resulting power saving may be more than 90% [7].

On the other hand, Handheld terminals with integrated antennas generally suffer from poor reception condition. This is due to both the antenna size being very small compared to wave length, and the motion of the terminal during

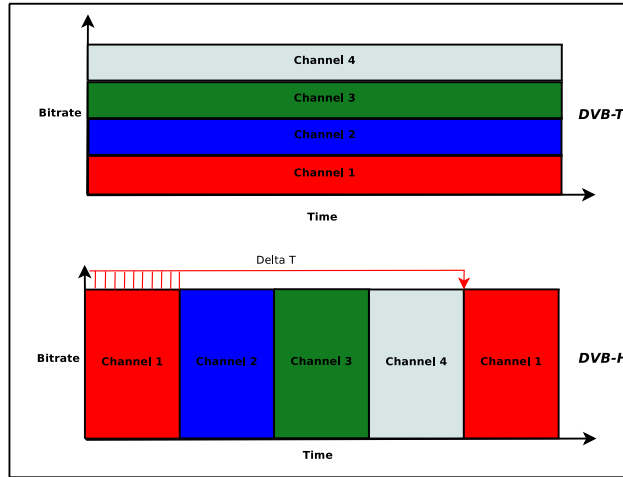

Figure 2: DVB-H versus DVB-T transmission

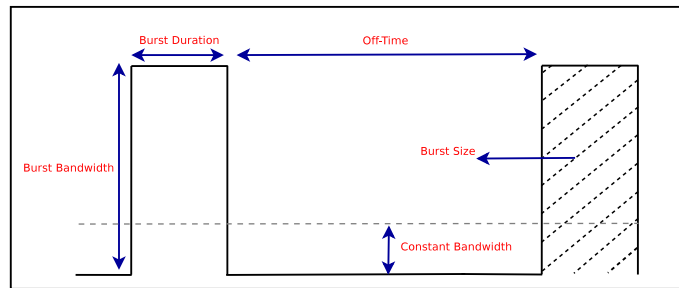

Figure 3: DVB-H Time Slicing

operation. The usage environment is largely different from the one of DVB-T receivers which are mostly used stationary and with an rooftop antennas. The two-stage coding operation of DVB-T (Reed-Solomon code and convolutional code) already providing a sufficient protection in stationary channels becomes not suitable to offer a good transmission quality for mobile users in Typical Urban channel profile (TU-6)¹. For this reason and in order to reduce the S/N requirements for reception by a handheld device a link layer FEC called MPE-FEC (Multi Protocol Encapsulation- Forward Error Correction) [8] was introduced. The MPE-FEC, called also Inner-FEC, is the second main innovation of DVB-H besides the time slicing. It consists in a Reed-Solomon (RS) code applied to a specific frame structure called the MPE-FEC frame. The MPE-FEC frame consists in a matrix of 256, 512, 768 or 1024 rows and a constant number of 255 columns. The frame is spread into two parts, the first 191 columns form the Application Data Table (ADT) and the 64 last ones form the FEC Data Table (FDT) (Fig. 4). Each cell corresponds to one byte. The IP datagrams of a service are grouped in bursts according to the time-slicing parameters (service bitrate, burst duration and off time). The ADT is then

¹TU-6 models the terrestrial propagation in an urban area. It uses 6 resolvable paths, each one characterized by a delay, a power and a fading model.

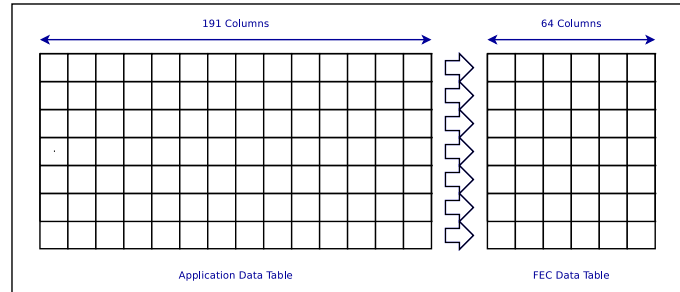

Figure 4: MPE-FEC frame structure

filled with the IP datagrams of one burst. After applying the RS(255, 191) code to the ADT row by row, the FDT will contain the parity bytes of the RS code. After the coding each IP datagram is encapsulated into an MPE Section and each FEC column is encapsulated into an MPE-FEC Section. The MPE-FEC error protection is calculated separately for each individual service.

DVB-SH [9] is a new standard defining the way to deliver “IP based media content and data” to handheld terminals using hybrid satellite/terrestrial solution. It employs a high-power geo-stationary satellite for cost-effective nationwide coverage and a network of low-power repeaters to provide urban and indoor coverage. This solution is based on an evolution of the DVB-H standard. DVB-H key technologies such as Orthogonal Frequency Division Multiplexing (OFDM) modulation, time slicing and IP datacasting are maintained while an improved link budget is achieved by employing turbo-codes. Furthermore, significant improvements are made within the terminals (higher antenna gains and reception diversity). Satellite ensures nationwide direct reception of up to nine channels at 256 kbits/s. Repeaters in urban areas re-transmit the received data at the frequency of the satellite carrier and will therefore offer indoor coverage. Synchronization between the terrestrial repeaters and the satellite allows the receiver to see the satellite signal as a simple echo of the terrestrial repeater signal². To increase the system capacity in urban areas, adjacent carrier transmitters complement the satellite signal, allowing the transmission of additional channels.

DVB-SH takes into account the specific properties of a direct satellite link for a mobile reception which introduces a new channel modeled often by an “LMS” (Land Mobile Satellite) model³. This kind of channel is characterized by long fading time where the signal can be interrupted for several seconds due to physical obstacles like tree, tunnel or weather conditions. The DVB-H MPE-FEC mechanism corrects errors within a burst with a maximum size of 1.5 Mbits (~1 second) and is not adapted for networks with long loss duration (~tens of seconds).

² Single Frequency Network (SFN) operation comes from the robustness of the transmission system against echoes. In fact echoes can be passively created by the environment (reflection, refraction, etc. in short, multipath propagations) or actively produced by active transmitters radiating on the same frequency, at the same time, the same bits.

³In satellite to mobile communications, there is generally in addition to the diffuse multipath component a strong line-of-sight component. The spectral and statistical properties of both components are influenced by shadowing caused by obstacles such as trees, houses or small buildings.

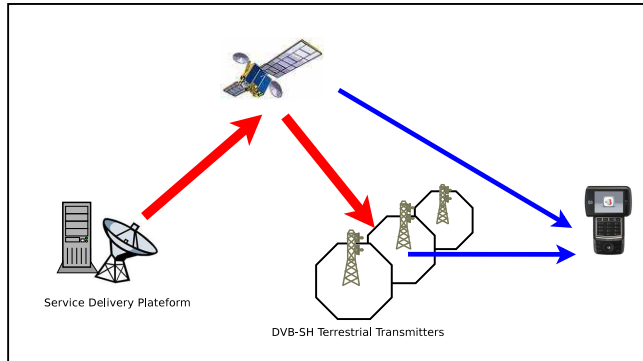

Figure 5: DVB-SH Broadcast System

In this paper, we propose a new algorithm called “Multi Burst Sliding Encoding” to offer a good transmission quality in satellite broadcasting systems for mobile devices, taking into account the power consumption and the memory constraint in handsets. This algorithm is capable of generating an outer FEC able to recover several consecutive lost bursts. It is compatible with the existing DVB-H standard and FEC computation can use the same RS(191,255) algorithm and can thus benefit from the existing hardware. The proposed encoding and decoding algorithms were implemented respectively in the UDCast IP-Encapsulator and the UDCast TS-Processor and several experiments were performed to evaluate the performance of the proposed solution.

The rest of the paper is organized as follows: section 2 describes the possible solutions to avoid long fading time and explains why they are not suitable for DVB-SH handheld class receivers. Then the “Multi Burst Sliding Encoding” algorithm is described in section 3 and a theoretical analysis of its recovering capacity is presented in section 4. In section 5, we show the experimental performance of our algorithm applied to the RS (191,255) for TU6 and LMS channels. Finally section 6 presents our conclusions and remarks.

2 Possible solutions to avoid long fading time

In order to provide a good quality streaming service over a channel with long fading it is necessary to operate the protection over a large block of data and to spread protected data and FEC over the time. A such long time encoder and interleaver can be located at the physical or at the data link layer. The two solutions are presented.

2.1 Physical layer long interleaver

Time interleaving consists in dispersion of data over time. The aim of interleaving is to gain diversity with respect to time variant channels: protected data are sent in several discrete bursts to disperse losses. With physical layer interleaving information received during poor reception condition are combined with information received during good reception conditions. If enough FEC is available, the original data can be recovered although parts have been erased by

the channel. In other words interleaving consists in averaging the channel over the interleaver length (duration). The adequate interleaver length depends on the type of channel considered. For a terrestrial channel, fast fading is dominant therefore short interleaver is sufficient. For a satellite channel, slow fading is the dominant factor and the interleaver lengths to be considered are in the order of several seconds [10, 11]. Reference [12] proposes an architecture of a long time interleaver for DVB-SH class receivers. In the receiver side, the transmitted signal is processed by the carrier recovery and the symbol timing recovery. Then the error correction decoding is processed with the demodulated data. The decoding process can be achieved by using either a high-complexity soft decision decoding or a lower performance, lower complexity hard decision decoding [13]. As it provides higher recovering capacity of the physical layer interleaver, only the soft decision decoding (SDD) will be considered. In SDD, the decoder front-end (or demodulator) does not make a hard decision about whether a 0 or 1 bit was transmitted but rather makes a soft decision corresponding to the distance between the received symbol and the symbol corresponding to a 0-bit or a 1-bit transmission. The demodulator produces an integer (coded on N bits) for each bit in the data stream. This integer could be seen as a measure of how likely it is that the bit is a 0 or a 1 and is also called soft bits. The integer could be drawn from the range $[-X, X]$, where: $-X$ means "certainly 0", X means "certainly 1" and 0 means "it could be either 0 or 1". Thus the soft bits should be stored in the de-interleaver in order to be used to make better decisions about the transmitted codeword. For a given channel, the higher the number of soft bits, the better the performance of the soft decision decoder [13].

However, the price to achieve the benefits of a long interleaver with a soft-decision is a higher memory usage on the receiver side. The memory consumption of a time interleaver is the product of the interleaver length (seconds) multiplied by the bit rate (bits per second) multiplied by the number of the bit-decision divided by the number of bits transmitted per symbol (1 for BPSK, 2 for QPSK, 4 for 16QAM, 6 for 64QAM...). For example at a bitrate of 12Mbps, an interleaver length of 20s, using a decoder with 12-bit decision and QPSK modulation, the required on-chip memory for the de-interleaver is 1440 Mbits.

Another considerable drawback of this solution is the loss of the power saving which derives from the time slicing since several services are interleaved together at the bit level and the decoder has to receive all services and extract the desired one after the deinterleaving operation.

For these reasons, even if the physical layer long interleaver can provide the required quality for the transmission, it is not suitable for handheld receivers with memory and battery limitations.

2.2 Link layer block encoding

Another way to enhance quality over channels with long fading is to apply a link layer protection mechanism. Such mechanism is mainly based on an extension of the encoding matrix size from one burst (in the DVB-H case) to several bursts and is using a large block FEC encoding mechanism for providing the protection [14].

The FEC encoder allocates an encoding matrix with a size of b bursts made of C data columns each. When a burst is received it is copied in the matrix and immediately sent to avoid delay in data transmission. For each b bursts, FEC

columns are computed using the desired FEC codec and the computed FEC columns are sent within the next b bursts. F_o FEC columns from the previous encoding matrix are sent with each burst (F_o depends on the FEC ratio and C).

The decoder allocates two matrices of b bursts each. The first one contains the previous b data bursts and will be used to store FEC columns being received. The second one is used to store data bursts being received. After receiving the data and the FEC of a given matrix, the decoding operation is performed.

With this mechanism if a whole block is lost then the FEC columns of the previous block are lost too. So to compute the recovery capacity of this mechanism we have to compute the minimum number of bursts belonging to the same block that must be received to enable the decoder recovering all bursts from the previous block. To recover the previous block the decoder needs to receive $b.C$ FEC columns which represent $\frac{b.C}{F_o}$ bursts. This makes sense only if $\frac{C}{F_o} \leq 1$. Therefore the decoder can recover up to n successive bursts such that $(2b - n)\frac{F_o}{C} \geq b$. This implies that $n \leq \lfloor 2b.(1 - \frac{C}{2F_o}) \rfloor$. This expression is bounded by $(M - 1)$ where $M = 2b$ is the decoder memory usage.

Even if this mechanism can provide the required protection depth it suffers from its ‘‘block’’ nature, and becomes sub-optimal for our target application for the reasons below:

1. To decode a FEC block made of k source symbols and $(n - k)$ parity symbols the decoder needs to receive any k among the n symbols. If the decoder receives $D = k - L$ source symbols and $F < L$ parity symbols, then no symbols can be recovered, i.e. if R defines the number of recovered symbols the probability $P((R > 0)|(L > F)) = 0$. Now we divide this FEC block into N smaller blocks each one made of $\frac{k}{N}$ source symbols and $\frac{n-k}{N}$ parity symbols. If the decoder receives for each small block $d_i = \frac{k}{N} - l_i$ data symbols and f_i parity symbols such that $\sum_{i=0}^{N-1} d_i = D$, $\sum_{i=0}^{N-1} f_i = F$ and $\sum_{i=0}^{N-1} l_i = L$. The probability to recover R source symbols among the L lost ones becomes:

$$\begin{aligned} P((R > 0)|(L > F)) &= \\ \sum_{i=0}^{N-1} \binom{N}{i} P(R_i > 0)^i P(R_i = 0)^{N-i} & \quad (1) \\ = 1 - P(R_i = 0)^N & \geq 0 \end{aligned}$$

$P(R_i)$ is the probability to recover R_i source symbols in a small block.

where $(L - F) < \frac{k.(N-1)}{N}$ yields that (1) is strictly greater than 0. In other words, large block FEC coding is not always better than small FEC blocks, and especially when the available FEC ratio ($\frac{FEC}{DATA+FEC}$) is less than the Packet Loss Rate (PLR) of the channel, or when the constraints on the width of the block (memory, delay,...) imply a lot of variability of the PLR over the blocks.

CPU clock	208Mhz	520Mhz	624Mhz
b=10	908ms	493ms	440ms
b=20	1804ms	892ms	867ms
b=10 (full screen)	2026ms	652ms	587ms
b=20 (full screen)	4094ms	1455ms	1232ms

Table 1: Raptor code simulations

2. In the case of packets loss, the decoder needs to receive the full block before the decoding starts. This induces a fixed delay on the reception time.
3. The end-to-end delay is bounded by $2 \times \textit{protection_period} + \textit{decoding_delay}$ where the decoding delay depends on the chosen FEC code [15]. For Reed Solomon it increases quadratically according to block size, and even if for some other codes like Raptor it increases linearly, it remains quite important, as shown by the following simulation: On the basis of reference [16], a C++ program simulating the Raptor decoding operations was embedded in a PDA (Dell Axim) with Windows Mobile 5 operating system. The simulator measures the time spent to execute the necessary operations to decode a block made of b bursts. The burst size was fixed to 288 MPEG2 transport packets. Table 1 shows the simulation results for $b = 10$ and $b = 20$ (the last two lines correspond to more consuming mode with Windows Media player running in full screen mode).
4. In handheld devices, the FEC decoding algorithm is implemented in a specific hardware because of its processing complexity. The chipset implementing the FEC decoder needs a fast memory buffer whose size is a little larger than the size of the FEC block (data + meta-data). This type of memory is quite expensive to implement.

3 The Multi Burst Sliding Encoding

In order to provide a better solution for TV broadcasting under a channel with a long fading time for a DVB-SH handheld class receiver, we propose a new mechanism called “Multi Burst Sliding Encoding” MBSE. The sliding encoding mechanism is a link layer solution for extending the duration of the protection while still using small size blocks. It extends the existing DVB-H MPE-FEC intra-burst protection to an inter-burst protection so that complete burst losses may be recovered by producing an “outer FEC” continuously and on a regular basis (a fraction of the protection is created every burst). In order to achieve this protection, data coming from several bursts are interleaved inside parallel matrices before FEC protection is applied, even if original data are not sent interleaved eventually. On the reception side, received data are also interleaved before being placed in decoding matrices. In order to achieve this extension we need the following parameters:

- B : The encoding parallelization factor expressed in encoding matrix units. Each burst is split into B parts distributed over B encoding matrices.

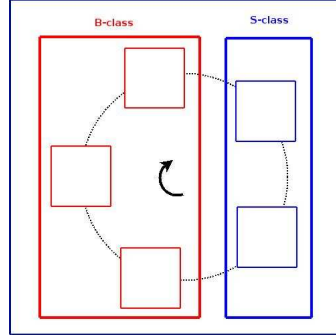

Figure 6: Sliding effect on the encoding matrices

- S : The depth of the FEC spreading factor, It means that produced FEC is spread over S bursts.
- F_o : Number of computed outer-FEC columns from an encoding matrix.

The algorithm works as follows: The encoder allocates a set of $B + S$ encoding matrices divided into two classes : B -class made of B matrices and S -class made of S matrices. At each iteration a sliding window (hence the name of the algorithm) is applied to the $B + S$ matrices and thus one matrix from the B -class goes to the S -class and vice versa as shown by the Figure 6 for $B = 3$ and $S = 2$.

Each data burst is considered as a matrix of bytes. To obtain a fixed number of lines and rows per matrix we consider the maximum burst size which is derived from the maximum service bitrate and the repetition interval. Bursts are padded to obtain a fixed burst size although the padding bytes are not sent. Each matrix is divided into B parts made of a number of non contiguous columns taken in a particular way. Each part is placed in a specific encoding matrix from the B -class. At each iteration only one specific encoding matrix from the S -class containing columns coming from several bursts is encoded and thus F_o FEC columns are generated. Each burst is sent as is without modification and without additional delay. At the end of the burst some FEC columns⁴, chosen in a specific way from the S -class matrices, are appended and sent. Receiver not supporting MBSE will just ignore the appended FEC bytes.

3.1 Encoder algorithm

Initialization

The encoder allocates $B + S$ encoding matrices $\{M_0, \dots, M_{(B+S-1)}\}$ with C columns and T rows each filled with zeros. Each encoding matrix M_i is composed of two parts: The application data table $MADT_i$ and FEC data table $MFDT_i$.

The following process is applied for each burst of data numbered k .

Step 1: Processing and transmission of the k^{th} data burst

⁴The number of FEC column per burst depends on the FEC ratio and the burst size

- Map the received data burst in an ADT noted ADT_k (like DVB-H MPE-FEC) of C columns and T rows.
- Send The data burst as is.
- Create a FEC burst containing F_o FEC columns $\{F_0, \dots, F_{F_o-1}\}$ extracted from S interleaved $MFDT$ $\{MFDT_{f(0,k)}, \dots, MFDT_{f(F_o-1,k)}\}$ among $B + S$. F_i is the i^{th} FEC column of the $MFDT_{f(i,k)}$. The f function is defined as:

$$f(j, k) = (k - j \bmod S - 1) \bmod (B + S) \quad (2)$$

- Each FEC column is encapsulated in an MPE-OFEC section. Each MPE-OFEC section carries the same information carried by a DVB-H MPE-FEC section and tow other pieces of information: The first one is the *burst_number* which is a burst continuity counter that will be used by the receiver to detect missed bursts. The second parameter is *prev_burst_size*, it indicates the size in bytes of the burst number $(k - i - 1)$, where k is the current burst number, and f_i is the MPE-OFEC section number. This will increase the performance of the decoder in the case of a complete burst loss since it will allow the receiver to generate exactly the right amount of missed columns in the ADT_k . In the case where the *prev_burst_size* of the data burst k is unknown all the column of the ADT_k will be considered as lost even if some columns contain padding bytes that was not transmitted but just signaled. B and S parameters can be carried either by an MPE-OFEC sections or in DVB-SH PSI/SI tables as the number of rows in DVB-H MPE-FEC

Step 2: Interleaving of the ADT_k (the k^{th} data burst) and outer FEC computation.

- Interleave the ADT_k inside B $MADT$ $\{MADT_{g(0,k)}, \dots, MADT_{g(C,k)}\}$ among $B + S$ such as the i^{th} column of the ADT_k ($C_{i,k}$) is copied into the $(C - 1)^{th}$ column of the $MADT_{g(i,k)}$ after shifting the matrix $MADT_{g(i,k)}$ by 1 column to the right ($C_{C-1} \rightarrow C_{C-2}, \dots, C_1 \rightarrow C_0$). The g function is defined as:

$$g(i, k) = (k + i \bmod B) \bmod (B + S) \quad (3)$$

- Encode the Matrix $M_{h(k)}$ using the desired FEC codec. The FEC encoding function generates the $MFDT_{h(k)}$ from the $MADT_{h(k)}$. The h function is defined as:

$$h(k) = k \bmod (B + S) \quad (4)$$

Optimization of the mapping/interleaving operations: To avoid the shifting operation of the $MADT$, we can copy the column C_i of the ADT_k directly in its final position in the $MADT_{g(i,k)}$ when the encoding matrix $M_{g(i,k)}$ will be encoded. The position of the column C_i of the data burst k (ADT_k) in the matrix $MADT_{g(i,k)}$ is given by the following formula:

$$p(i) = (B - i \bmod B - 1) \times \lfloor \frac{C}{B} \rfloor + \max(0, C \bmod B - i \bmod B - 1) + \lfloor \frac{i}{B} \rfloor \quad (5)$$

Figure 7 shows a simple example of an encoder with $B = 3$, $S = 2$ and $F_o = 3$. We suppose that each burst can be mapped on an ADT with 5 columns.

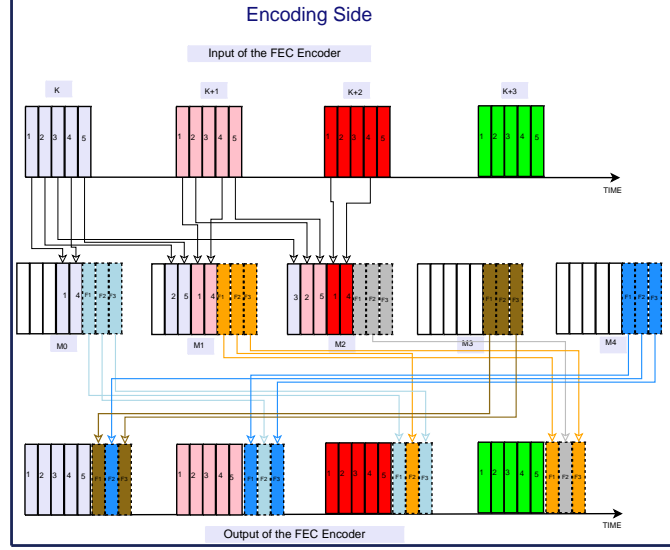

Figure 7: MBSE Encoder

3.2 Decoder algorithm

Initialization

The decoder allocates $B + S$ encoding matrices $\{M_0, \dots, M_{(B+S-1)}\}$ with C columns and T rows each filled with zeros, each encoding matrix is composed of two parts. The application data table $MADT_i$ and FEC data table $MFDT_i$.

The following process is applied for each received burst of data numbered k

Step 1: Reception of the k^{th} burst

- A burst consists of a data burst and outer FEC columns. The burst number must be extracted from one of the received outer FEC columns. In the case where no outer FEC is received, the burst is ignored and considered as lost. The burst number is used as a continuity counter to detect missed bursts. When a burst k is detected as lost, an empty ADT is created (filled with 0).

- The data burst of the burst k is mapped into an ADT noted ADT_k (like DVB-H MPE-FEC) of size C columns and T rows.

Step 2: Outer FEC insertion

- The received outer FEC columns $\{F_0, \dots, F_{F_o-1}\}$ of the burst k are inserted into S $MFDT$ $\{MFDT_{f(0,k)}, \dots, MFDT_{f(F_o,k)}\}$ among $B + S$ (where the f function is defined in (2)) such as the FEC column i of the burst k is inserted in the column i of the $MFDT_{f(i,k)}$.

- The *prev_burst_size* value carried by the outer FEC section i of the burst k indicates the size of the data burst $(k - i - 1)$. Therefore the $MADT_{(k-i-1)}$ is padded from the byte $(prev_burst_size - 1)$ to the byte $(T.C - 1)$.

Step 3: Matrix decoding and burst retrieving

- At each received burst k , the encoding Matrix $M_{u(k)}$ can be decoded and then de-interleaved. The u function is defined as follows:

$$u(k) = (k + B) \bmod (B + S) \quad (6)$$

- The IP datagrams are extracted from $MADT_{l(k)}$ and passed to the upper layer. The l function is defined as follows:

$$l(k) = (k - B - S + 1) \bmod (B + S) \quad (7)$$

step 4: Data interleaving

- The ADT_k is interleaved inside $BMADT \{MADT_{g(0,k)}, \dots, MADT_{g(C,k)}\}$ such that the i^{th} column of the ADT_k ($C_{i,k}$) is copied into the $p(i)^{th}$ column of the $MADT_{g(i,k)}$. p and g functions are defined respectively by (5) and (3).

4 Performance Analysis

In the following section, we derive an expression of the burst recovery capacity of the multi-burst sliding encoding.

A burst k is made of C data columns mapped into an ADT , and F_o outer FEC columns. In order to recover a lost burst k , all the encoding matrices containing a portion of that burst must be successfully decoded (all erasure recovered). At the encoder the ADT_k is interleaved with the $(B - 1)$ previous $ADT \{ADT_{k-(B-1)}, ADT_{k-(B-2)}, \dots, ADT_{k-1}\}$ and with the $(B - 1)$ next $ADT \{ADT_{k+1}, ADT_{k+2}, \dots, ADT_{k+(B-1)}\}$ inside B Encoding Matrices $\{M_{h(k)}, M_{h(k+1)}, \dots, M_{h(k+B-1)}\}$. Each matrix contains $\frac{C}{B}$ data columns coming from the ADT_k . In the case of a ‘‘perfect FEC code’’, the decoder needs to receive $\frac{C}{B}$ FEC columns for each encoding matrix $M_{h(k)}$. This makes sense only if $\frac{C}{B} \leq F_o$. On the other hand the FEC columns produced by the encoding of the matrix $M_{h(k)}$ are spread over the S next bursts $\{Burst_{k+1}, Burst_{k+2}, \dots, Burst_{k+S}\}$. Each $Burst_{k+i}$ contains $\frac{F_o}{S}$ FEC columns coming from the encoding matrix $M_{h(k)}$. Therefore to retrieve the burst k the decoder needs to receive the $(B - 1)$ previous bursts and the $\lceil B - 1 + \frac{C \cdot S}{B \cdot F_o} \rceil$ next bursts.

In a more general case when n successive bursts $\{ADT_k, ADT_{k+1}, \dots, ADT_{k+n-1}\}$ are lost, the set of the involved encoding matrices is χ defined by:

$$\chi = \{M_{h(k)}, M_{h(k+1)}, \dots, M_{h(k+\min(B;n)-1)}, \\ M_{h(k+\min(B;n))}, \dots, M_{h(k+\min(B;n)-1)}, \\ M_{h(k+\max(B;n))}, \dots, M_{h(k+n+B-2)}\} \quad (8)$$

To show more clearly the calculations, we divide the set χ into three subsets χ_1 , χ_2 and χ_3 such that:

$$\chi_1 = \{M_{h(k)}, M_{h(k+1)}, \dots, M_{h(k+\min(B;n)-1)}\} \\ \chi_2 = \{M_{h(k+\min(B;n))}, \dots, M_{h(k+\max(B;n)-1)}\} \\ \chi_3 = \{M_{h(k+\max(B;n))}, \dots, M_{h(k+n+B-2)}\} \\ \chi = \chi_1 \cup \chi_2 \cup \chi_3 \quad (9)$$

To decode the matrices of χ_1 , the set of bursts ψ_1 must be received by the decoder and the constraint C_1 must be satisfied. ψ_1 and C_1 are defined by:

$$\psi_1 = \{Burst_{k+n}, \dots, Burst_{k+m_1}\} \quad (10)$$

$$C_1 : \begin{cases} \lceil n + (j+1) \frac{C.S}{B.F_o} - 1 \rceil \leq j + S \\ \forall j \mid 0 \leq j \leq \min(B; n) - 1 \end{cases} \quad (11)$$

$$m_1 = \lceil n + \min(B; n) \cdot \frac{C.S}{B.F_o} - 1 \rceil \quad (12)$$

To decode the matrices of χ_2 , the set of the bursts ψ_2 must be received by the decoder and the constraint C_2 must be satisfied. ψ_2 and C_2 are defined by:

$$\psi_2 = \{Burst_{k+n}, \dots, Burst_{k+m_2}\} \quad (13)$$

$$C_2 : \begin{cases} \lceil n - \min(B + j + 1; n) + \\ + \min(B; n) \frac{C.S}{B.F_o} - 1 \rceil \leq S \\ \forall j \mid 0 \leq j \leq |n - B| - 1 \end{cases} \quad (14)$$

$$m_2 = \lceil \max(B; n) + \min(B; n) \cdot \frac{C.S}{B.F_o} - 1 \rceil \quad (15)$$

To decode the matrices of χ_3 , the set of the bursts ψ_3 must be received by the decoder and the constraint C_3 must be satisfied. ψ_3 and C_3 are defined by:

$$\psi_3 = \{Burst_{k+\max(B;n)+1}, \dots, Burst_{k+m_3}\} \quad (16)$$

$$C_3 : \lceil (\min(n; B) - 1) \frac{C}{B.F_o} \rceil \leq 1 \quad (17)$$

$$m_3 = \lceil \max(B; n) + (\min(B; n) - 1) \times \frac{C.S}{B.F_o} \\ + (\min(B; n) - 2) \times (1 - \frac{C.S}{B.F_o}) \rceil \quad (18)$$

Therefore, to decode all matrices of χ , the set of the bursts $\psi = \psi_1 \cup \psi_2 \cup \psi_3$ must be received by the decoder and the constraint C (satisfying C_1 , C_2 and C_3) must be satisfied. ψ and C are defined by:

$$\psi = \{Burst_{k+n}, \dots, Burst_{k+m}\} \quad (19)$$

$$C : \lceil n - \min(B; n) \times (1 - \max(\frac{C.S}{B.F_o}; 1)) \rceil \leq S \quad (20)$$

$$m = \lceil \max(B; n) + \frac{C.S}{B.F_o} - 1 + \\ \max(\frac{C.S}{B.F_o}; 1) \times (\min(B; n) - 1) \rceil \quad (21)$$

From (20), we can see that when $\frac{C.S}{B.F_o} \leq 1$ the maximum recovery capacity of the MBSE algorithm becomes S successive bursts. On the other hand when $\frac{C.S}{B.F_o} > 1$ then $C.S \leq B.F_o$. Or B is equal to $M - S$ so $S \leq \frac{M}{(\frac{F_o}{C} + 1)}$. This means that the MBSE is able to recover up to $\frac{M}{(\frac{F_o}{C} + 1)}$ consecutive lost bursts. For large enough FEC percentage ($\frac{F_o}{C}$) This expression (bounded by M) can reach $(M - 1)$. This means that MBSE has the same maximum recovering capacity as the large block encoding which is also $(M - 1)$ consecutive lost bursts as shown in section 2.2.

To recover the n successive lost bursts, the decoder needs to receive bursts from $k + n$ to $k + m$. When condition C is satisfied, we obtain $m - n \leq B + S$. Therefore the optimum values of B and S for a given FEC percentage ($\frac{F}{C}$) and a fixed value of $B + S$ are computed by solving the following linear program:

$$\begin{aligned} & \text{Maximize} && S \\ & \text{Subject to} && \frac{C \cdot S}{B \cdot F_c} \leq 1 \\ & && B + S = M \end{aligned} \quad (22)$$

Since only one matrix among M has to be decoded at a time, the size of the required fast memory (on chip) is only one burst, which is also the case of the DVB-H terminals. The rest of the memory can be allocated at the host level.

5 Experimental Performance of the sliding encoding

5.1 Trace files based simulations

In the following section we have applied both the RS (191,255) MBSE and the ideal block encoding algorithms (optimistic results for block encoding) to some link layer DVB-SH trace files implementing different reception scenarios provided by the DVB-SSP work group[17]. The aim is to compare their performance recovery according to Errored Second Ratio 5% (ESR5)⁵ and the Packet Loss Rate (PLR).

5.1.1 Simulation tools

A simulation code written in C Linux process the dump files and applies the two decoding algorithms. For the MBSE it takes as input the B+S parameters and the FEC ratio, and for the block encoding algorithm the block size and the FEC ratio. It gives for each trace file the PLR and the ESR5. The simulator is section CRC aware; this means that if an MPEG2 transport packet (TP) has an erroneous bits then the simulator count as erroneous the hwole section carried by this TP. Other policies exist where the decoder can take the risk to process a section with bad CRC [18].

The dump files implement different receive scenarios. each scenario is characterized by a carrier to noise ratio (C/N), a propagation environment (LMS sub-urban or terrestrial urban) and a receiver speed. A dump file represents a single service extracted from a MUX of 8 services and it contains the index of the erroneous MPEG2 packets.

For the simulation the following assumption are done:

- Repetition interval : 1 second.
- IP packet size: 1000 bytes.
- MPE overhead: 16 Bytes.

⁵ESR: seconds with errors over an observation period. ESR5 corresponds to 1 second with error over a 20 seconds observation period.

Case	C/N	Environment	Speed
sub-50-6	6db	LMS	50Km/h
su-50-10	10db	LMS	50Km/h
sub-3-6	6db	LMS	3Km/h
sub-3-10	10db	LMS	3Km/h
Tu6-3-5	5db	Terrestrial urban	3Km/h
Tu6-5-3.3	3.3db	Terrestrial urban	5Km/h
Tu6-50-4	4db	Terrestrial urban	50Km/h

Table 2: Receive scenarios

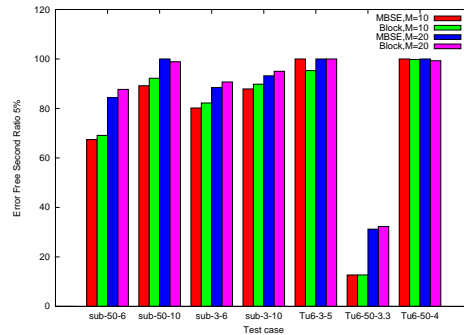

Figure 8: 1-ESR5 MBSE versus ideal Block

- Section packing is enabled (an MPEG2 transport packet can carry two parts of two different sections).
- The FEC ratio is 33%

The considered receive scenarios are given by table 2:

5.1.2 Simulation results

Figure 8 reports the 1-ESR5 (or EFSR5 Error Free Second Ratio 5%) performance for both the MBSE with Reed Solomon (191,255) and the large block encoding with an ideal code. When comparing the performance of the two encoding algorithm for the same memory usage (M) according to the EFSR5 criteria we can remark that there is not a significant difference between them and the two algorithms have a very closely near performance (the difference is under 2%).

Regarding Figure 9 which reports PLR we can remark that MBSE performs better than block encoding and this can be explained by the fact that the block encoding can not decode the block when the number of packet losses is greater than the available FEC packets while the MBSE can decode some small blocks.

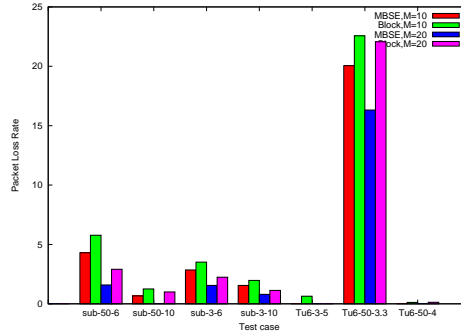

Figure 9: PLR MBSE versus Block

5.2 Experiments with an emulated link

In the following we applied the RS(191,255) MBSE algorithm to a live stream while varying the C/N and the B+S. The aim is to evaluate the gain provided by the MBSE compared to DVB-T and DVB-H.

5.2.1 Test bed description

The encoding and decoding algorithms of the MBSE are implemented in the UDCast DVB-SH IP-Encapsulator and in the UDCast TS-Processor respectively. For experimental purpose the test bed described in Figure 10 is set up. The MPE and MPE-OFEC sections are generated so that an IP datagram forms the payload of an MPE-section and an outer-FEC column forms the payload of an MPE-OFEC section. The MPE and MPE-OFEC sections are then fragmented into MPEG2 packets carried through an ASI cable to a DVB-SH COFDM modulator. The modulated signal was passed through a hardware channel emulator implementing the TU6 multipath channel model [19] and the Land Mobile Satellite LMS model [20]. The Noisy signal is demodulated by the DVB-SH signal demodulator and the generated MPEG2 packets are passed to the MBSE decoder to generate the IP datagrams. The IP analyzer gives statistics on the PLR, the Errored Second Ratio (ESR) and the EFSR5. Finally by processing the files generated by the TS recorders 1 and 2, we can generate a link layer trace file.

The following parameters are used in the experiments :

- Repetition interval :1 second
- MBSE FEC ratio : 33%
- Physical layer FEC ratio :50%
- Physical layer interleaving: 100ms
- Physical modulation: QPSK

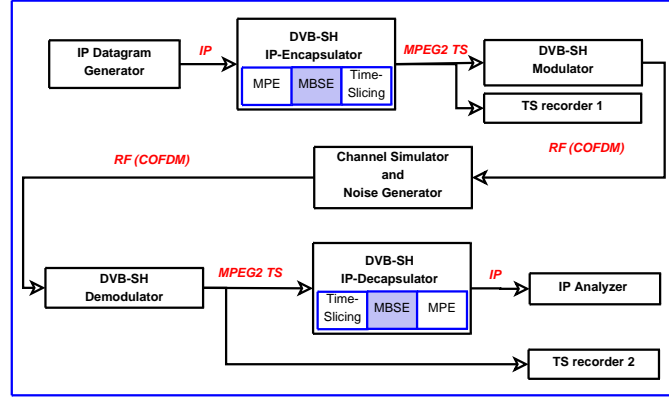

Figure 10: DVB-SH Test bed

5.2.2 Experiments Results

Figures 11, 12 and 13 show respectively the EFSR5, the PLR and the ESR for the MBSE algorithm with different value of B+S while varying the carrier to noise ratio in an LMS channel model for a mobile receiver at 3Km/h. From these set of curves, several interesting observations can be drawn. Firstly we can remark that in an LMS channel the DVB-H MPE FEC is not usable since it can not provide a good transmission quality even if we use a high transmission power, the service availability (EFSR5) is bounded by $\sim 80\%$. Secondly the higher M (B+S) the better the performance of the MBSE scheme in terms of EFSR5, PLR and ESR; for example an EFSR of 99% can be reached either by using a B+S=10 at 6.5 db or a B+S=30 at 5.3db. Finally we can observe a better performance of the MBSE with M=2 (no data interleaving) comparing to MPE-FEC mechanism. This can be explained by the fact that in the MBSE the FEC of a given data burst is sent with the next burst while in MPE-FEC the FEC and the corresponding data are sent in the same burst.

Regarding Figures 15, 16, 17 which report respectively the EFSR5, the PLR and the ESR while varying the C/N in a TU6 channel model for a mobile receiver at 3Km/h, we can remark that even if MBSE was designed for an LMS channel, it can improve significantly the performance of the receiver in term of data recovering under a terrestrial transmission (TU6) and thus it can be interesting for DVB-H, WiMAX and other burst based transmission protocols. Considering a service availability ratio (1-ESR5) higher than 99% we can remark that with MBSE using M=30 we can achieve a gain of ~ 3 db compared to a receiver without a link layer FEC mechanism and a gain of ~ 2 db compared to a DVB-H MPE-FEC mechanism.

This gain in terms of C/N can be used by the broadcasters to increase the coverage area of the transmitters or to reduce the transmission power of the base stations while maintaining the same coverage area and the same quality of service. It can also help to save the bandwidth as the required protection can be provided by increasing the B+S factor (memory usage) while decreasing the FEC ratio as shown by the Figure 14.

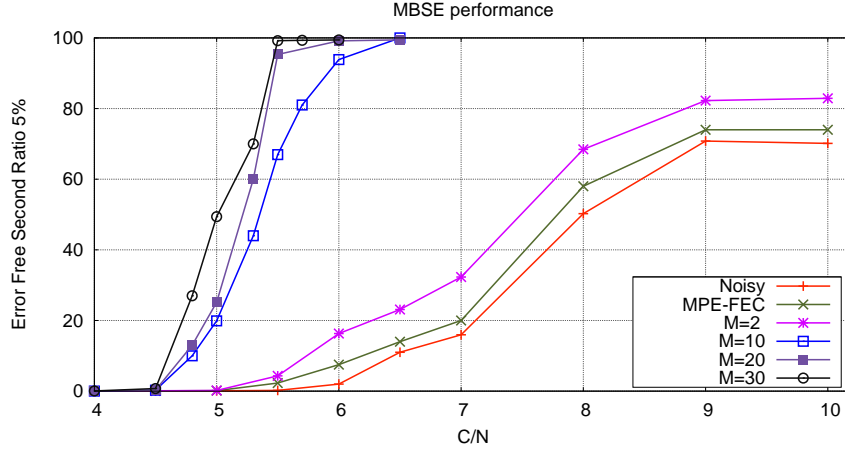

Figure 11: Error Free Second Ratio 5% in an LMS channel for a FEC ratio of 33% while varying the memory usage

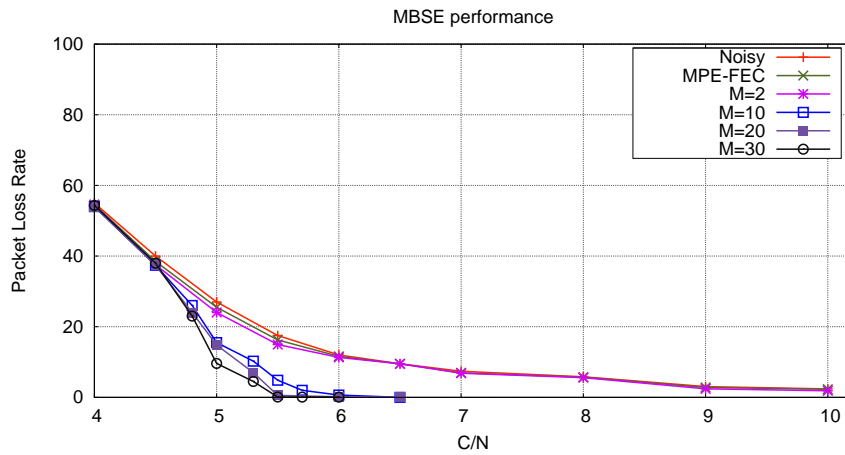

Figure 12: Packet Loss Rate in an LMS model for a FEC ratio of 33% while varying the memory usage

6 Conclusion

In this paper we have proposed an innovative algorithm called MBSE (Multi Burst Sliding Encoding) performing a sliding encoding at the link layer level to protect transmitted data against long fading time. We have derive an analytic expression to study the recovery capacity of our solution then we validated it by simulations and by a real implementation and experiments. It offers significant advantages comparing to the other solutions as follows:

- Good performance in terms of protection as shown by the simulations and experiments
- Helps to save battery as it provides by design an individual service protection and enables the use of time slicing technique as in DVB-H

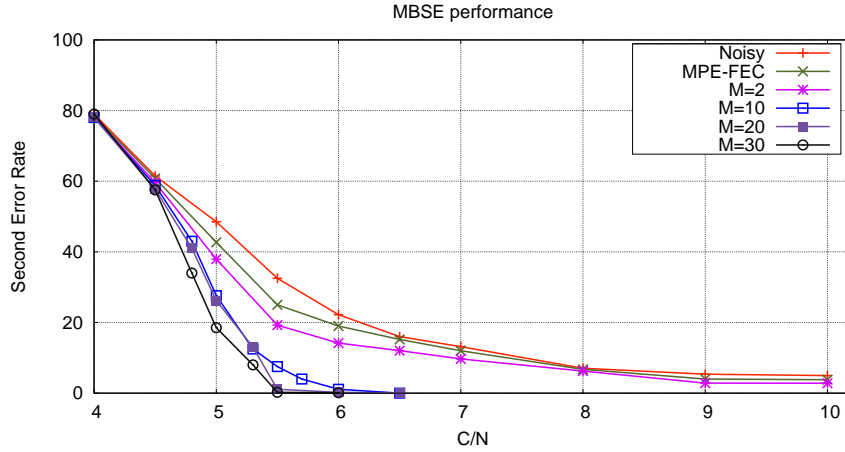

Figure 13: Errored Second Ratio in an LMS model for a FEC ratio of 33% while varying the memory usage

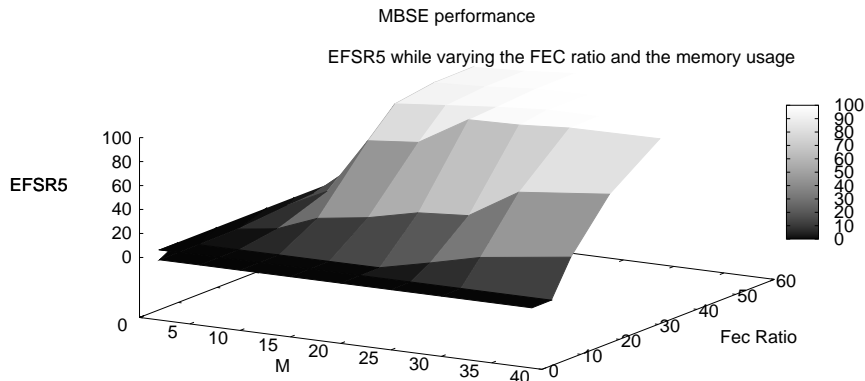

Figure 14: Error Free Second Ratio 5% in an LMS channel at 5.5db while varying the FEC ratio and the memory usage

- Helps to save memory, as it only needs the hard-decided bits of the desired service while still providing good performance
- Helps to save the bandwidth as the required protection can be provided either by increasing the FEC ratio or by increasing the memory usage.
- A better CPU usage by spreading the decoding operations over the time without impairing the power saving
- Versatility in the code enabling the reuse of the existing Reed Solomon (RS) ideal code
- A faster time to market with RS code since it is already used in DVB-H MPE-FEC and implemented in DVB-H chipsets.

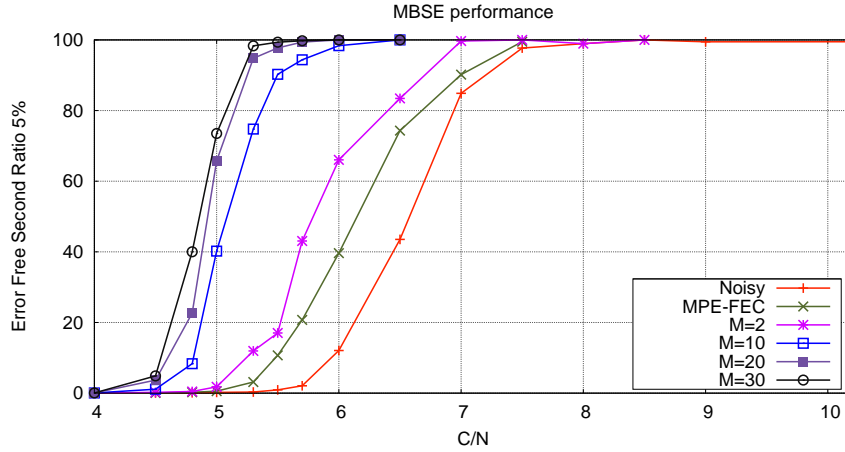

Figure 15: Error Free Second Ratio 5% in a TU6 channel for a FEC ratio of 33% while varying the memory usage

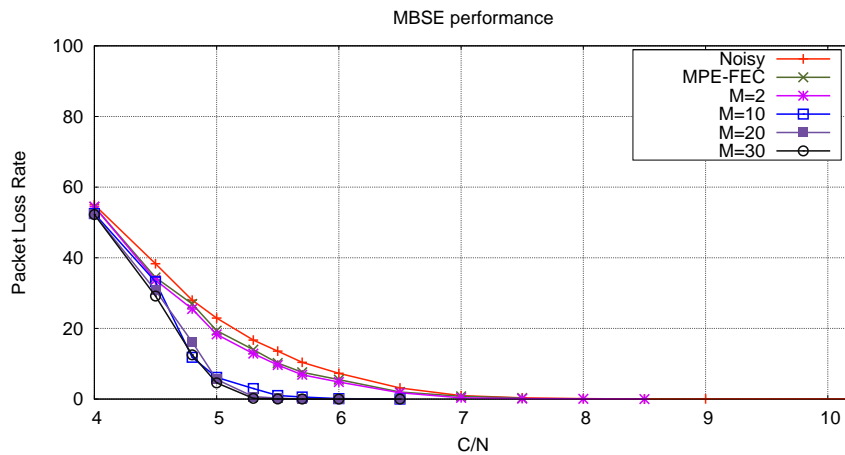

Figure 16: Packet Loss Rate in a TU6 channel for a FEC ratio of 33% while varying the memory usage

Our algorithm was approved by the TM-SSP DVB work group, it is considered as the main solution for the DVB-SH class terminals and it is now under standardization by the DVB-Forum as MPE-iFEC (i for inter-burst) [21, 22]. Several implementations of the MBSE are currently in progress and some tests on field will start in the next months.

As a future work, we intend to study a recursive decoding between the MPE-FEC and MBSE for DVB-SH, and we will adapt our current design for a better protection of variable bitrate flows. Finally, we will consider the interest of MBSE for the WiMAX Multicast and Broadcast Service (MBS) and for some other burst-based technologies.

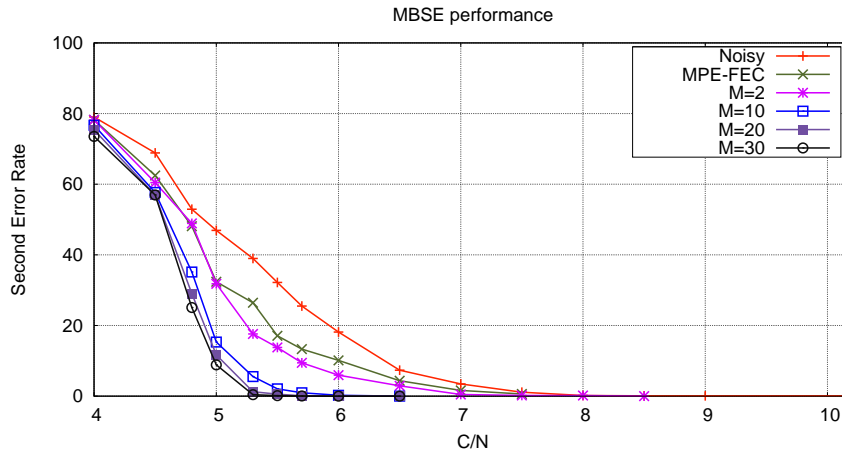

Figure 17: Errored Second Ratio in a TU6 channel for a FEC ratio of 33% while varying the memory usage

References

- [1] I. S. Reed and G. Solomon, "Polynomial Codes Over Certain Finite Fields," *SIAM Journal of Applied Math*, vol. 8, pp. 300–304, 1960.
- [2] R. G. Gallager, "Low-density parity-check codes," *M.I.T. Press, Cambridge, Massachusetts*, 1963.
- [3] A. Shokrollahi, "Raptor Codes," *IEEE Trans. Inf. Theory*, vol. 52(6), pp. 2551–2567, Jun. 2006.
- [4] *Framing Structure, Channel Coding and Modulation for Terrestrial Television*, Digital Video Broadcasting (DVB) Std. ETSI (EN) 300 744, Nov. 2004, release 1.5.1.
- [5] *Information Technology-Generic Coding Of Moving Pictures And Associated Audio Information:Systems*, International Organization for Standardization (ISO) Std. ISO/IEC 13 818-1, 2000, second edition.
- [6] *Transmission System for Handheld Terminals (DVB-H)*, Digital Video Broadcasting (DVB) Std. ETSI (EN) 302 304, Nov. 2004, release 1.1.1.
- [7] M. Kornfeld and G. May, "DVB-H and IP Datacast–Broadcast to Handheld Devices," *IEEE Trans. Broadcast.*, vol. 53, no. 1, Mar. 2007.
- [8] *DVB-H Implementation Guide-lines*, Digital Video Broadcasting (DVB) Std. ETSI TR 102 377, Nov. 2005, release 1.2.1.
- [9] *System Specifications for Satellite Services to Handheld Devices (SH) Below 3 GHz*, Digital Video Broadcasting (DVB) Working Draft Proposed Standard DVB-SSP0162, Rev. 5, Jan. 2007, release 1.6.2.

-
- [10] M. Akhter, "Performance of Channel Interleaved Turbo Coded System for High Rate Mobile Satellite Communications," in *Personal, Indoor and Mobile Radio Communications (PIMRC 2000)*, London, United Kingdom, Sep. 2000.
- [11] S. Cioni, G. E. Corozza, M. Neri, and A. Vanelli-Coralli, "On the Use of OFDM Radio Interface for Satellite Digital Multimedia Broadcasting Systems," *International Journal Of Satellite Communication And Networking*, vol. 24, no. 2, 2006.
- [12] C. Keip, "Physical Layer Interleaving and FEC," Digital Video Broadcasting (DVB), Tech. Rep. DVB-SSP0019, May 2006.
- [13] K. Lee, D. S. Hani, and K. Kim, "Performance of the Viterbi Decoder for DVB-T in Rayleigh Fading Channel," *IEEE Trans. Consum. Electron.*, vol. 44, no. 3, Aug. 1998.
- [14] T. Stockhammer, "Upper Layer FEC for DVB-SH with Raptor Code," Digital Video Broadcasting (DVB), Tech. Rep. DVB-SSP0251, Jun. 2007.
- [15] O. A. U. Demir, "Raptor Versus Reed Solomon Forward Error Correction Codes," *International Symposium on Computer Networks*, pp. 264–269, Jun. 2006.
- [16] "Report of MBMS FEC Status in SA4," TSG SA WG4 Codec, Quebec, Canada, Tech. Rep. TSGS28 (05)0246, Jun. 2005.
- [17] DVB Forum home page. [Online]. Available: <http://www.dvb.org>
- [18] J. Paavola, H. Himmanen, T. Jokela, J. Poikonen, and V. Ipatov, "The Performance Analysis of MPE-FEC Decoding Methods at the DVB-H Link Layer for Efficient IP Packet Retrieval," *IEEE Trans. Broadcast.*, vol. 53, no. 1, Mar. 2007.
- [19] G. Faria, J. A. Henriksson, E. Stare, and P. Talmola, "DVB-H: Digital Broadcast Services to Handheld Devices," in *Proceedings of the IEEE*, vol. 94, no. 1, Jan. 2006, pp. 194–209.
- [20] O. Rousset and J. L. Pavy, *SSH-2000-DVB-SH Signal Generator Technical Specification*, Teamcast, Mar. 2008, release 4.3.
- [21] *MPE-IFEC specification*, Digital Video Broadcasting (DVB) Working Draft Proposed Standard SSP0329, Rev. 2, May 2008.
- [22] *DVB-SH Implementation Guidelines*, Digital Video Broadcasting (DVB) Working Draft Proposed Standard DVB-SSP 0252r9f, Rev. 14, Apr. 2008.

Contents

1	Introduction	3
2	Possible solutions to avoid long fading time	6
2.1	Physical layer long interleaver	6
2.2	Link layer block encoding	7
3	The Multi Burst Sliding Encoding	9
3.1	Encoder algorithm	10
3.2	Decoder algorithm	12
4	Performance Analysis	13
5	Experimental Performance of the sliding encoding	15
5.1	Trace files based simulations	15
5.1.1	Simulation tools	15
5.1.2	Simulation results	16
5.2	Experiments with an emulated link	17
5.2.1	Test bed description	17
5.2.2	Experiments Results	18
6	Conclusion	19



Centre de recherche INRIA Sophia Antipolis – Méditerranée
2004, route des Lucioles - BP 93 - 06902 Sophia Antipolis Cedex (France)

Centre de recherche INRIA Bordeaux – Sud Ouest : Domaine Universitaire - 351, cours de la Libération - 33405 Talence Cedex
Centre de recherche INRIA Grenoble – Rhône-Alpes : 655, avenue de l'Europe - 38334 Montbonnot Saint-Ismier
Centre de recherche INRIA Lille – Nord Europe : Parc Scientifique de la Haute Borne - 40, avenue Halley - 59650 Villeneuve d'Ascq
Centre de recherche INRIA Nancy – Grand Est : LORIA, Technopôle de Nancy-Brabois - Campus scientifique
615, rue du Jardin Botanique - BP 101 - 54602 Villers-lès-Nancy Cedex
Centre de recherche INRIA Paris – Rocquencourt : Domaine de Voluceau - Rocquencourt - BP 105 - 78153 Le Chesnay Cedex
Centre de recherche INRIA Rennes – Bretagne Atlantique : IRISA, Campus universitaire de Beaulieu - 35042 Rennes Cedex
Centre de recherche INRIA Saclay – Île-de-France : Parc Orsay Université - ZAC des Vignes : 4, rue Jacques Monod - 91893 Orsay Cedex

Éditeur
INRIA - Domaine de Voluceau - Rocquencourt, BP 105 - 78153 Le Chesnay Cedex (France)
<http://www.inria.fr>
ISSN 0249-6399