

Matching of asymptotic expansions for the wave propagation in media with thin slot

Sébastien Tordeux, Patrick Joly

► **To cite this version:**

Sébastien Tordeux, Patrick Joly. Matching of asymptotic expansions for the wave propagation in media with thin slot. AG Analysis und Numerik, 2005, Baal, Switzerland. 2005. <inria-00528070>

HAL Id: inria-00528070

<https://hal.inria.fr/inria-00528070>

Submitted on 21 Oct 2010

HAL is a multi-disciplinary open access archive for the deposit and dissemination of scientific research documents, whether they are published or not. The documents may come from teaching and research institutions in France or abroad, or from public or private research centers.

L'archive ouverte pluridisciplinaire **HAL**, est destinée au dépôt et à la diffusion de documents scientifiques de niveau recherche, publiés ou non, émanant des établissements d'enseignement et de recherche français ou étrangers, des laboratoires publics ou privés.

Matching of asymptotic expansions for the wave propagation in media with thin slot

Sébastien Tordeux and Patrick Joly

AG Analysis und Numerik, January 2005

INRIA-Rocquencourt-Projet POEMS

ETH-SAM

A typical application

How can we study the scattering in media with **thin slot** ?

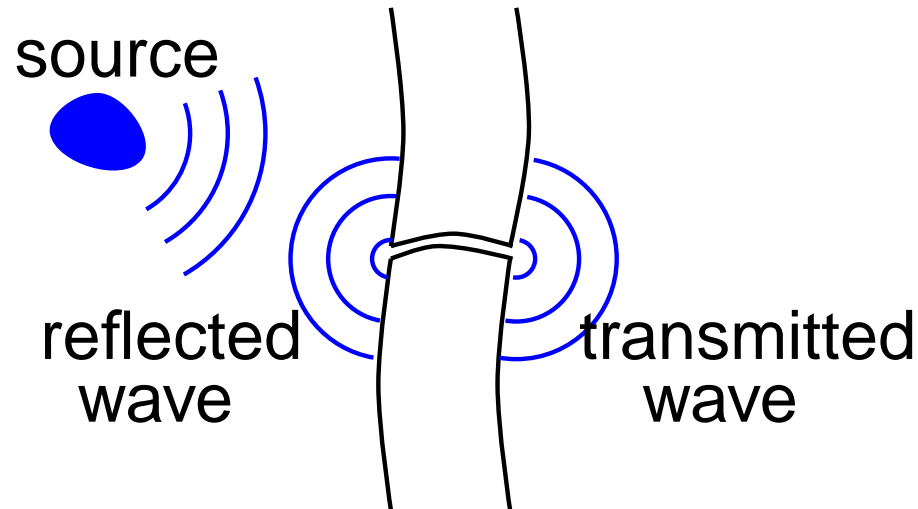

A physical problem with two **characteristical** lengthes

- The **wavelength** λ
- The **width** of the slot ε

A typical application

How can we study the scattering in media with **thin slot** ?

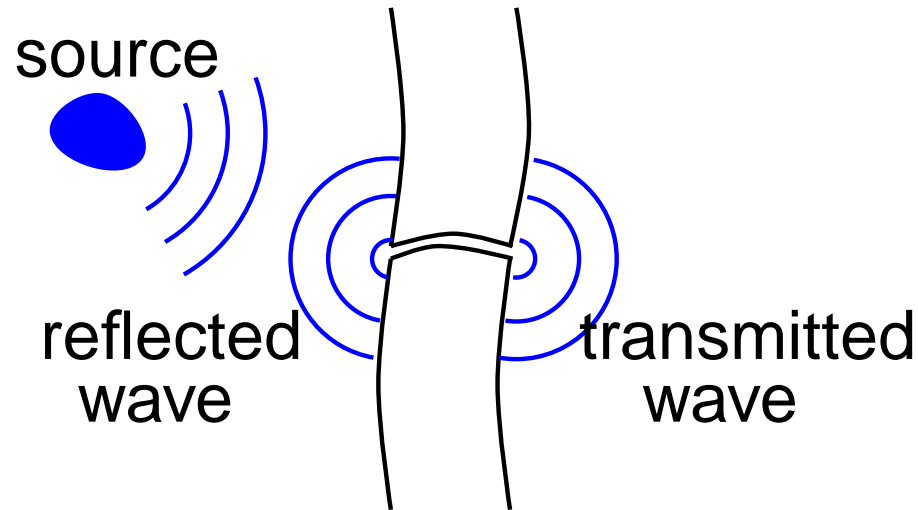

An **asymptotic** case:

$$\varepsilon \ll \lambda$$

The numerical difficulty

A **mesh step** smaller than ε

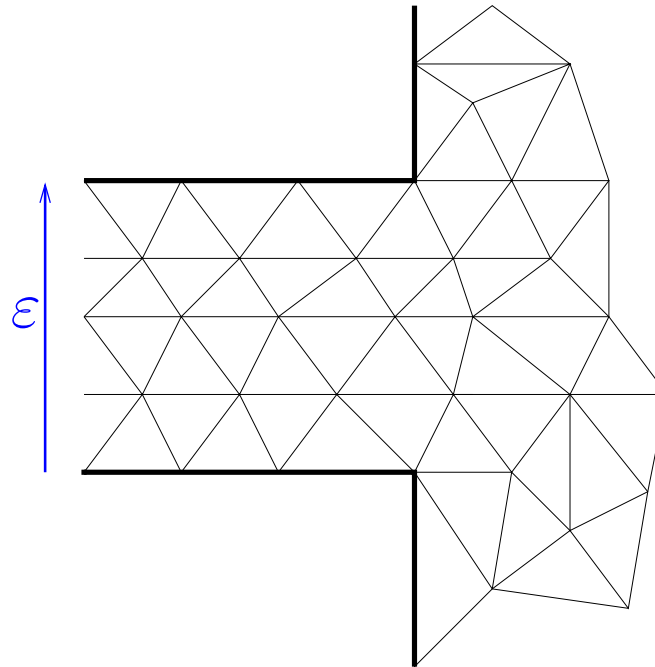

This leads to **costly** computations

Some references

- Thin slot:
[Harrington, Auckland](#) (1980), [Tatout](#) (1996).
- Finite differences:
[Taflove](#) (1995).
- Thin plates and junction theory,...
[Ciarlet, Le Dret, Dauge-Costabel](#).
- Matching of asymptotic expansions:
[McIver, Rawlins](#) (1993), [Il'in](#) (1992).
- multiscale analysis
[Maz'ya, Nazarov, Plamenevskii](#) (1991)
[Oleinik, Shamaev, Yosifian](#) (1992)

A simple problem

Scalar wave equation:

$$\frac{\partial^2 p^\varepsilon}{\partial t^2} - \Delta p^\varepsilon = f$$

Harmonic solution:

$$p^\varepsilon(x, y, t) = \exp(-i\omega t) u^\varepsilon(x, y)$$

Helmholtz Equation:

$$\Delta u^\varepsilon + \omega^2 u^\varepsilon = -f \quad \text{in } \Omega^\varepsilon$$

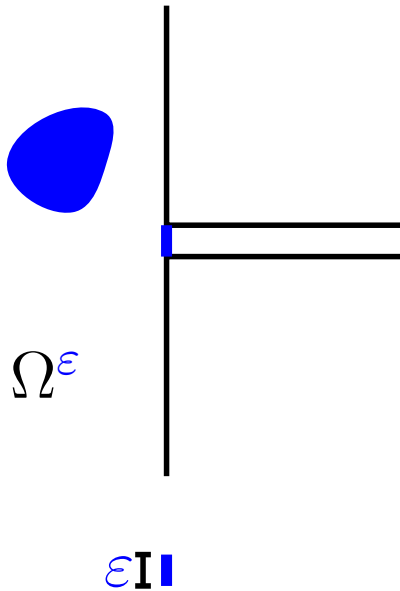

A simple problem

Outgoing solution at infinity:

$$\frac{\partial u^\varepsilon}{\partial n} - i\omega u^\varepsilon \leq \frac{C}{r^2}, \quad \text{for } r \text{ large,}$$

Neumann limit condition
(rigid wall)

$$\frac{\partial u^\varepsilon}{\partial n} = 0 \quad \text{on } \partial\Omega^\varepsilon$$

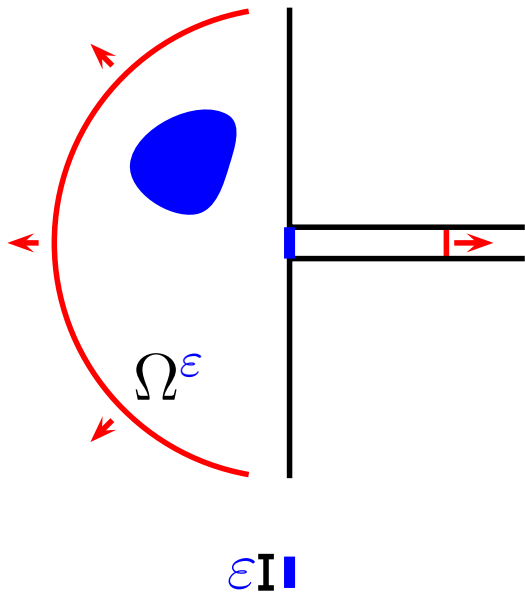

A simple problem

Outgoing solution at infinity:

$$\frac{\partial u^\varepsilon}{\partial n} - i\omega u^\varepsilon \leq \frac{C}{r^2}, \quad \text{for } r \text{ large,}$$

Neumann limit condition
(rigid wall)

$$\frac{\partial u^\varepsilon}{\partial n} = 0 \quad \text{on } \partial\Omega^\varepsilon$$

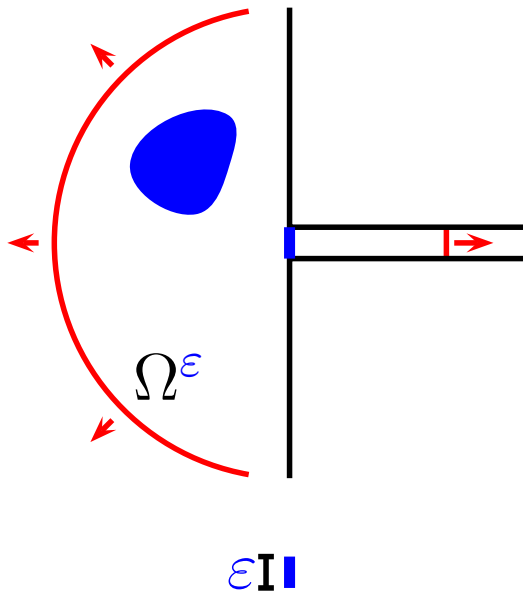

With the **Dirichlet** limit condition, the transmission inside the slot is **negligible** ($o(\varepsilon^\infty)$).

A numerical computation

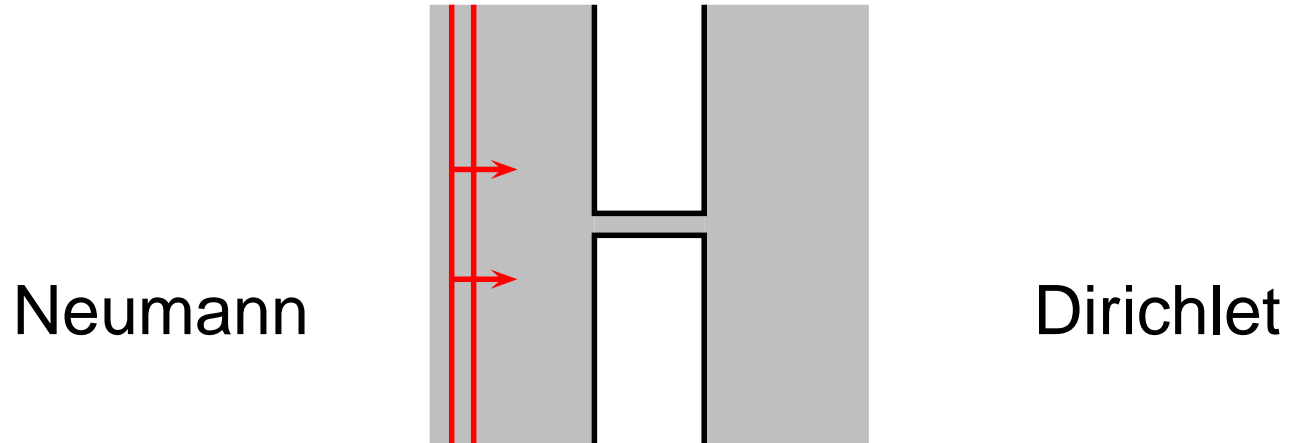

Numerical computation done with the **high order finite elements code** of (M. Duruflé, INRIA)

A numerical computation

Neumann

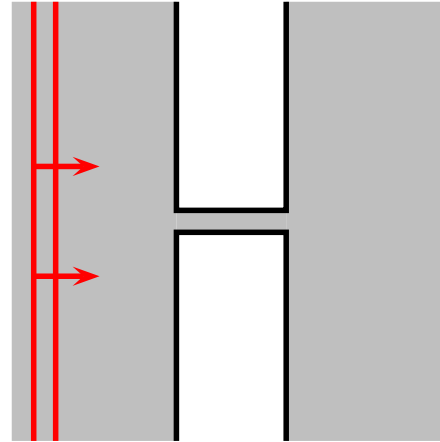

Dirichlet

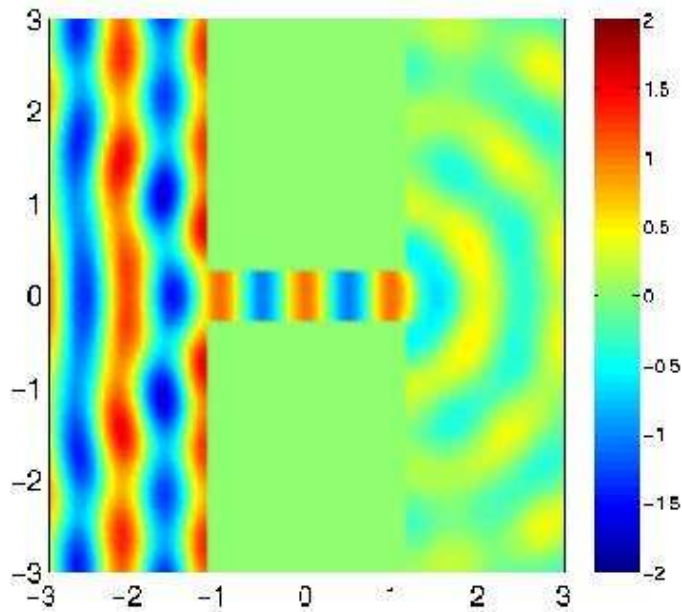

$$\frac{\varepsilon}{\lambda} = 0.5$$

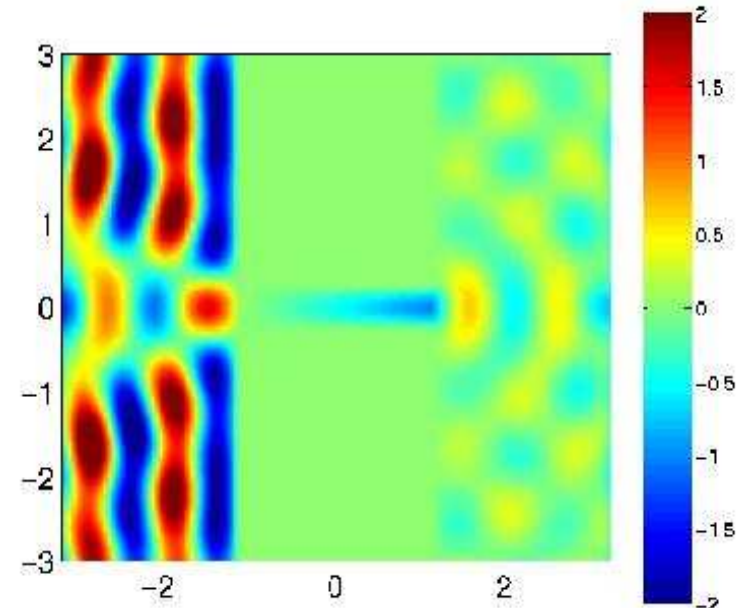

A numerical computation

Neumann

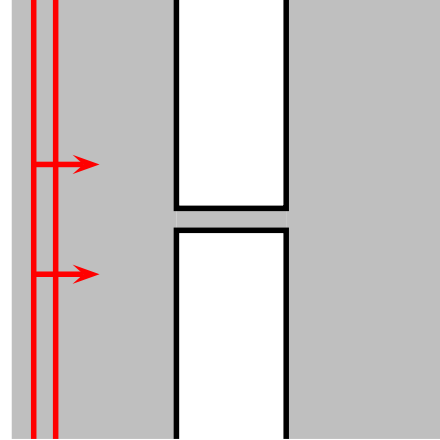

Dirichlet

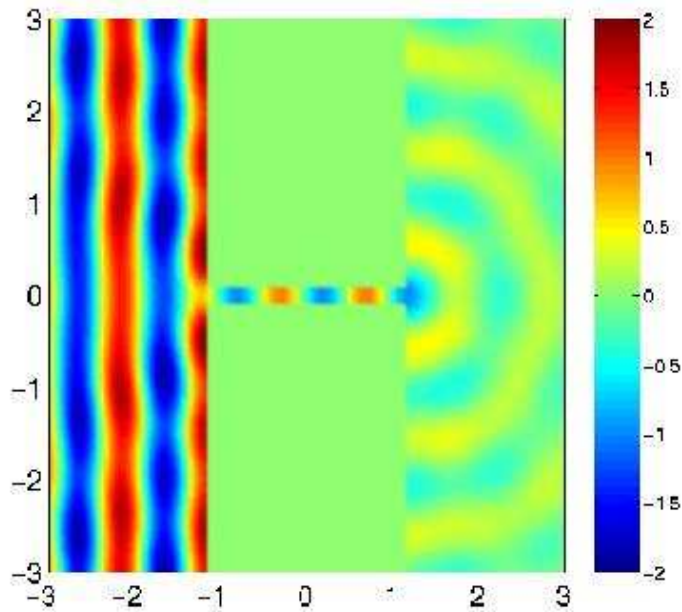

$$\frac{\varepsilon}{\lambda} = 0.2$$

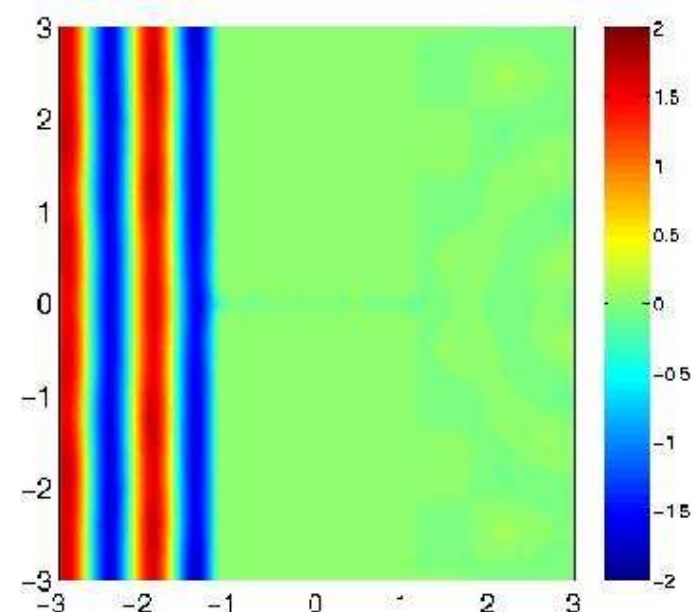

A numerical computation

Neumann

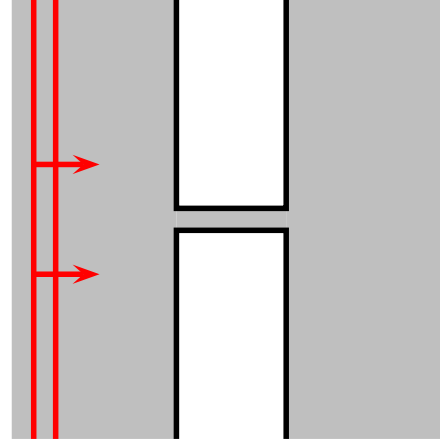

Dirichlet

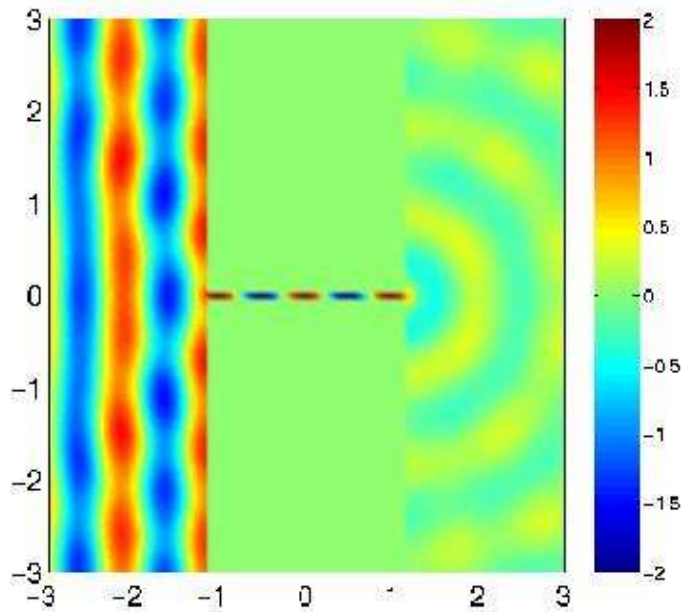

$$\frac{\varepsilon}{\lambda} = 0.1$$

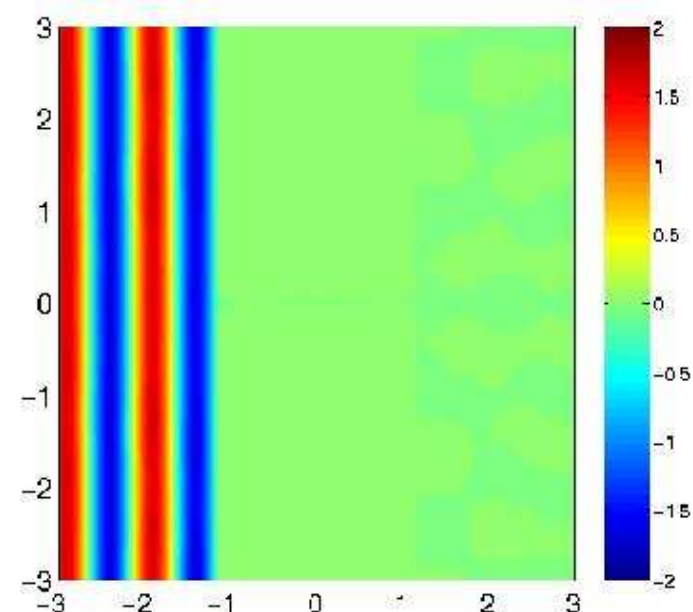

Objectives

- Introduce **accurate** numerical methods

Objectives

- Introduce **accurate** numerical methods
- We need an **intermediate zone**

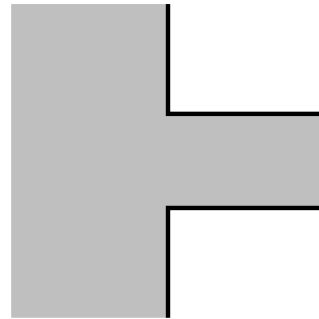

Objectives

- Introduce **accurate** numerical methods
- We need an **intermediate zone**

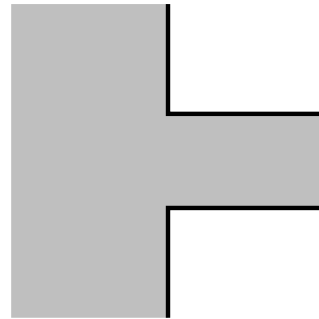

- A technique **the matching of asymptotic expansions**
 - Define **new approximate models** to compute the solution.
 - Use effectively “universal” technique of numerical computation (mesh reffinement).

Contributions to the match. of as. exp.

- A new presentation of the **matching principle** (not allways clear) postulated by the english school.

Contributions to the match. of as. exp.

- A new presentation of the **matching principle** (not always clear) postulated by the english school.
- The **mathematical justification** of this technique.
 - The proof are **inspired** by the multiscale technique
 - **Existence and unicity** of the terms of the expansions.
 - Specific technique: **error estimates**.

Three zones

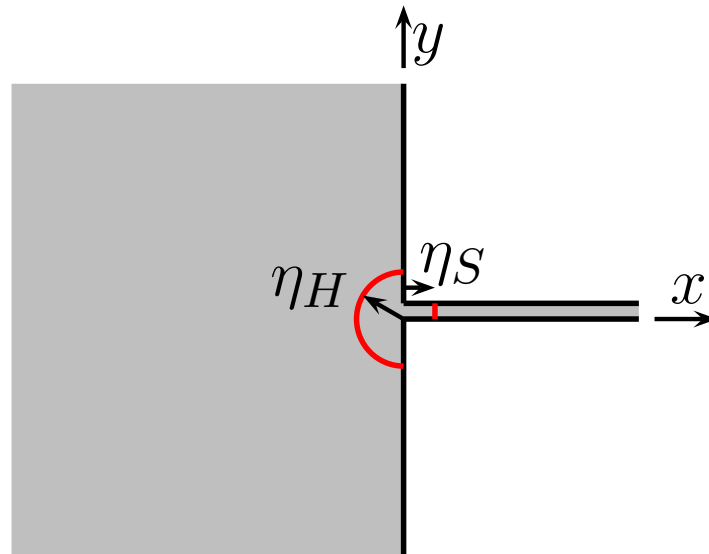

- Far field (2D field)
- Near field (boundary layer)
- Slot field (1D field)

Three zones

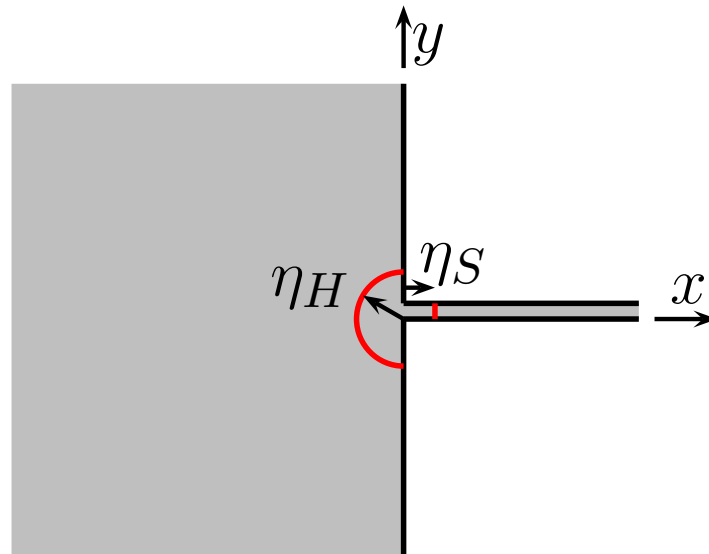

The **asymptotic assumptions**:

$$\varepsilon \ll \eta_H(\varepsilon) \ll \lambda, \quad \varepsilon \ll \eta_S(\varepsilon) \ll \lambda.$$

$$\varepsilon \rightarrow 0 \quad \eta(\varepsilon) \rightarrow 0 \quad \eta(\varepsilon)/\varepsilon \rightarrow +\infty$$

Three zones

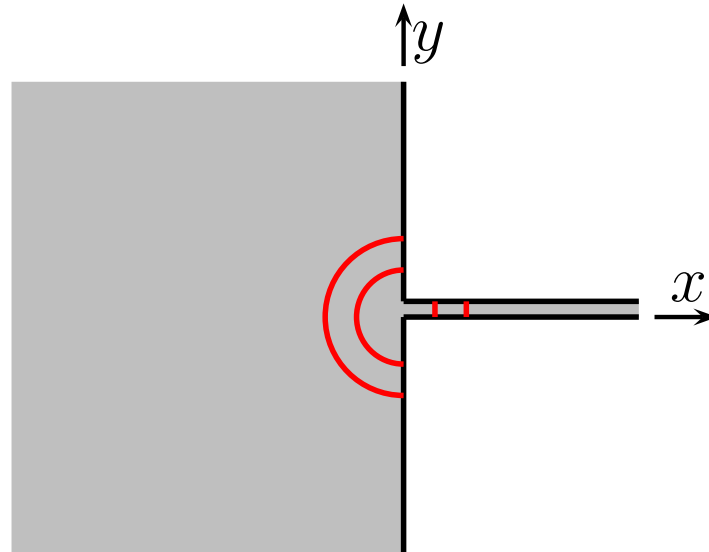

The asymptotic assumptions:

$$\varepsilon \ll \eta_H(\varepsilon) \ll \lambda, \quad \varepsilon \ll \eta_S(\varepsilon) \ll \lambda.$$

$$\varepsilon \rightarrow 0 \quad \eta(\varepsilon) \rightarrow 0 \quad \eta(\varepsilon)/\varepsilon \rightarrow +\infty$$

Three zones

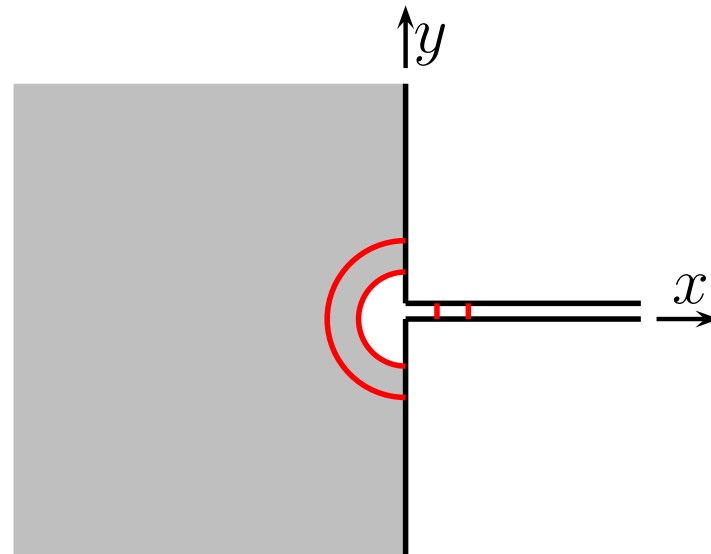

Far field

The **asymptotic assumptions**:

$$\varepsilon \ll \eta_H(\varepsilon) \ll \lambda,$$

$$\varepsilon \ll \eta_S(\varepsilon) \ll \lambda.$$

$$\varepsilon \rightarrow 0$$

$$\eta(\varepsilon) \rightarrow 0$$

$$\eta(\varepsilon)/\varepsilon \rightarrow +\infty$$

Three zones

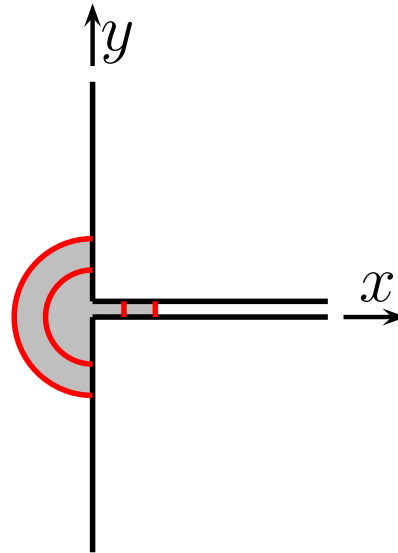

Near field

The **asymptotic assumptions**:

$$\varepsilon \ll \eta_H(\varepsilon) \ll \lambda, \quad \varepsilon \ll \eta_S(\varepsilon) \ll \lambda.$$

$$\varepsilon \rightarrow 0 \quad \eta(\varepsilon) \rightarrow 0 \quad \eta(\varepsilon)/\varepsilon \rightarrow +\infty$$

Three zones

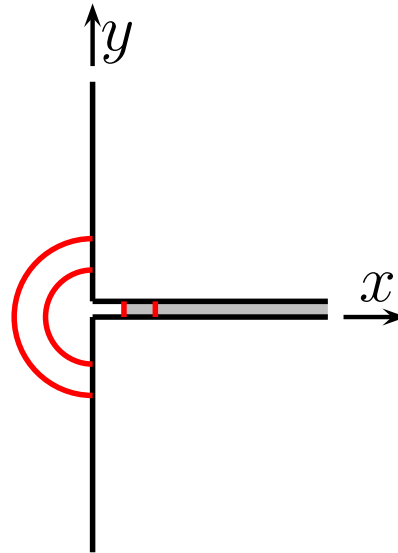

Slot field

The **asymptotic assumptions**:

$$\varepsilon \ll \eta_H(\varepsilon) \ll \lambda, \quad \varepsilon \ll \eta_S(\varepsilon) \ll \lambda.$$

$$\varepsilon \rightarrow 0 \quad \eta(\varepsilon) \rightarrow 0 \quad \eta(\varepsilon)/\varepsilon \rightarrow +\infty$$

Three zones

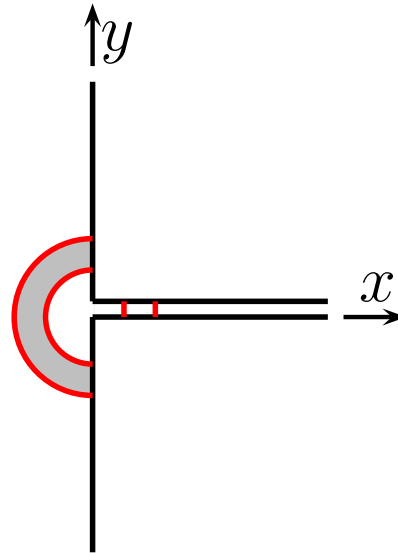

Far and near

The **asymptotic assumptions**:

$$\varepsilon \ll \eta_H(\varepsilon) \ll \lambda, \quad \varepsilon \ll \eta_S(\varepsilon) \ll \lambda.$$

$$\varepsilon \rightarrow 0 \quad \eta(\varepsilon) \rightarrow 0 \quad \eta(\varepsilon)/\varepsilon \rightarrow +\infty$$

Three zones

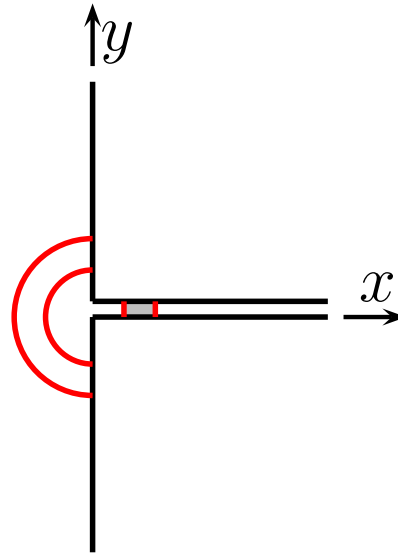

Slot and near

The **asymptotic assumptions**:

$$\varepsilon \ll \eta_H(\varepsilon) \ll \lambda, \quad \varepsilon \ll \eta_S(\varepsilon) \ll \lambda.$$

$$\varepsilon \rightarrow 0 \quad \eta(\varepsilon) \rightarrow 0 \quad \eta(\varepsilon)/\varepsilon \rightarrow +\infty$$

The different steps of the method

- **Derivate** the asymptotic expansions:
 - **Formal** part
 - Several presentations are possible

The different steps of the method

- **Derivate** the asymptotic expansions:
 - **Formal** part
 - Several presentations are possible
- **Describe** the asymptotic expansions
 - **Rigorous** part
 - **Definition** of the terms of the asymptotic expansions

The different steps of the method

- **Derivate** the asymptotic expansions:
 - **Formal** part
 - Several presentations are possible
- **Describe** the asymptotic expansions
 - **Rigorous** part
 - **Definition** of the terms of the asymptotic expansions
- **Mathematical validation** of the asymptotic expansions
 - **Rigorous** part
 - **Error estimates**

The different steps of the method

- 2 **Derivate** the asymptotic expansions:
 - **Formal** part
 - Several presentations are possible
- 1 **Describe** the asymptotic expansions
 - **Rigorous** part
 - **Definition** of the terms of the asymptotic expansions
- 3 **Mathematical validation** of the asymptotic expansions
 - **Rigorous** part
 - **Error estimates**

Far field

Asymptotic context: $\varepsilon \ll \eta_H \ll \lambda.$

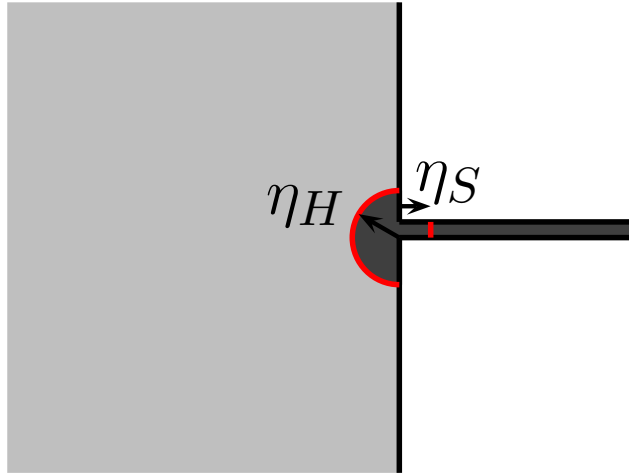

Far field

Asymptotic context: $\varepsilon \ll \eta_H \ll \lambda.$

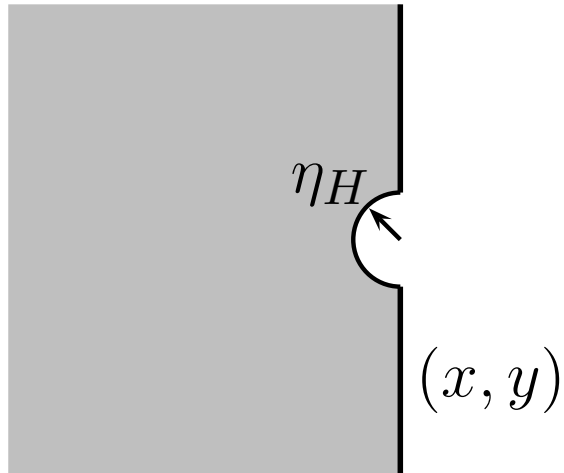

No **normalization**:

$$X = x,$$

$$Y = y.$$

Far field

Asymptotic context:

$$\varepsilon \ll \eta_H \ll \lambda.$$

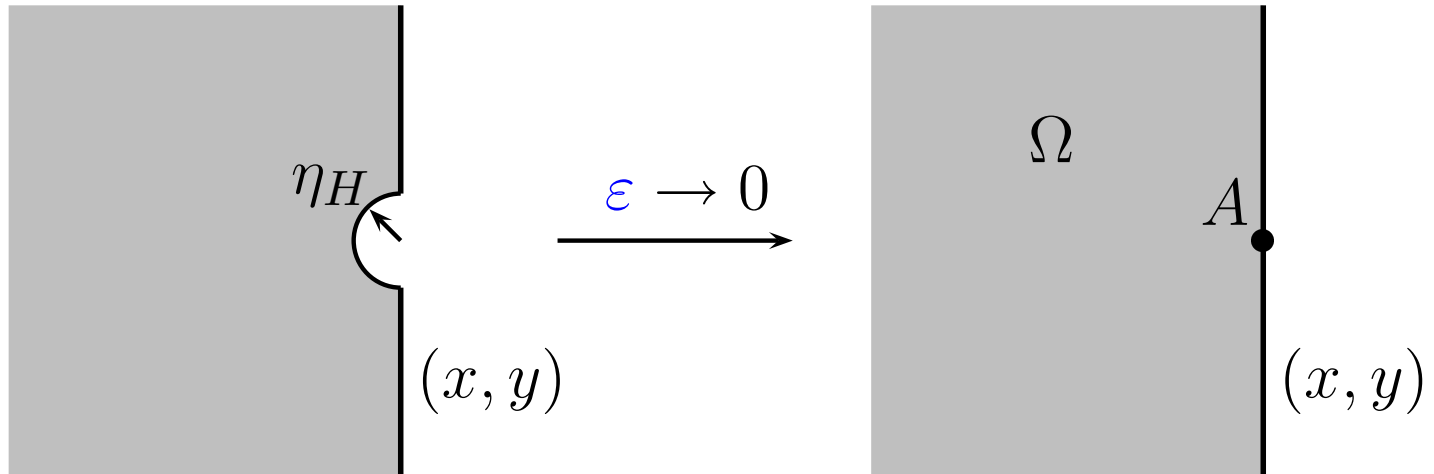

No **normalization**:

$$X = x,$$

$$Y = y.$$

Far field

Asymptotic context:

$$\varepsilon \ll \eta_H \ll \lambda.$$

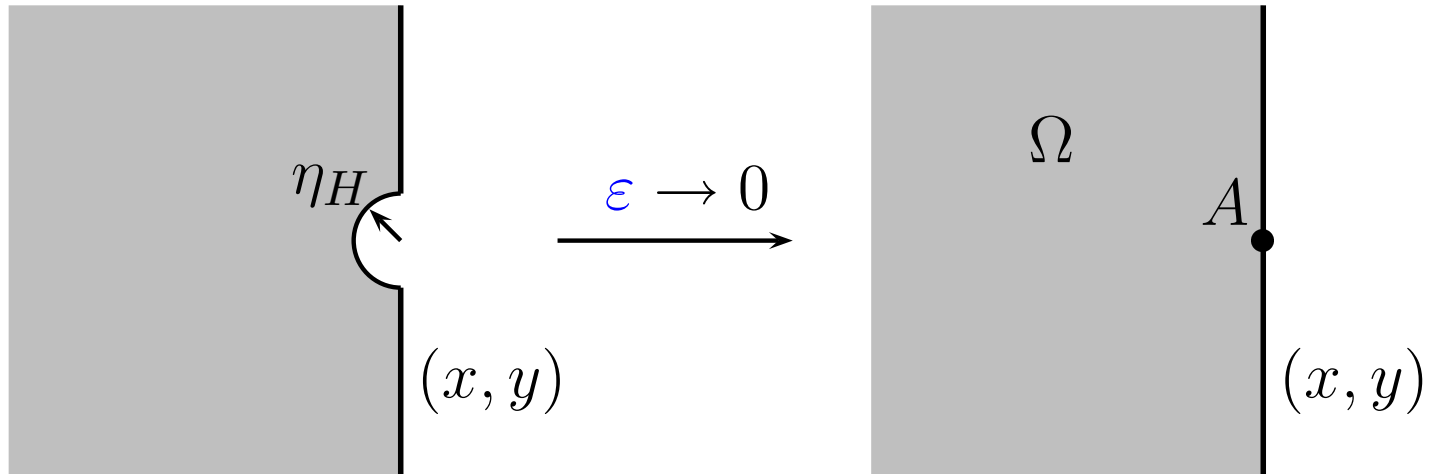

$$u^\varepsilon = u^0 + \sum_{i=1}^{+\infty} \sum_{k=0}^{i-1} \varepsilon^i (\log \varepsilon)^k u_i^k + o(\varepsilon^\infty), \quad \text{in } \Omega.$$

Far field

Asymptotic context:

$$\varepsilon \ll \eta_H \ll \lambda.$$

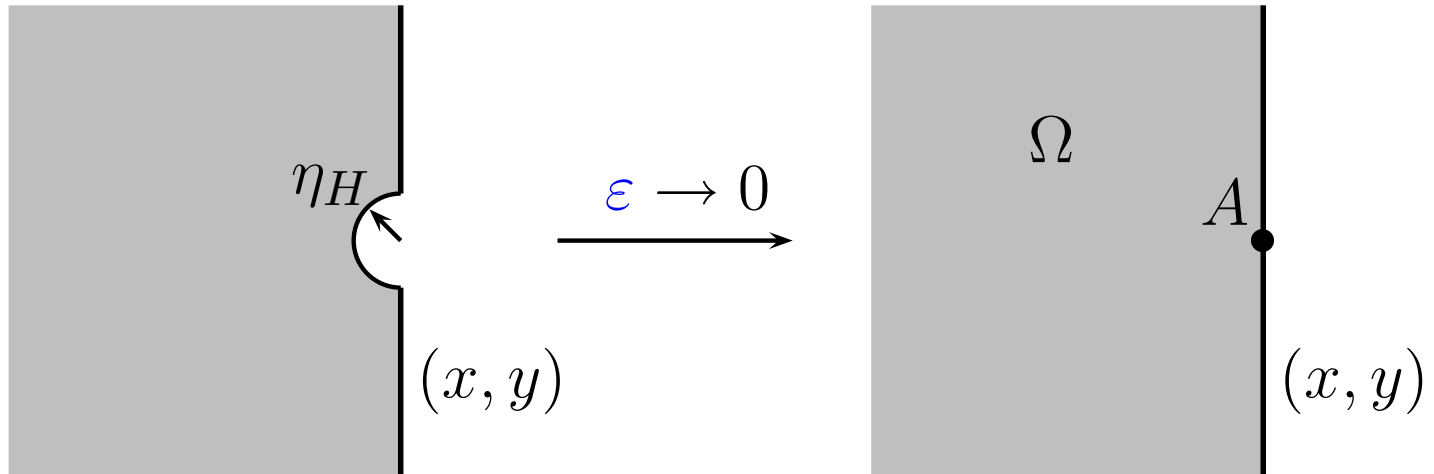

where the u_i^k satisfy the **homogeneous Helmholtz** equation

$$\Delta u_i^k + \omega^2 u_i^k = 0.$$

Slot field

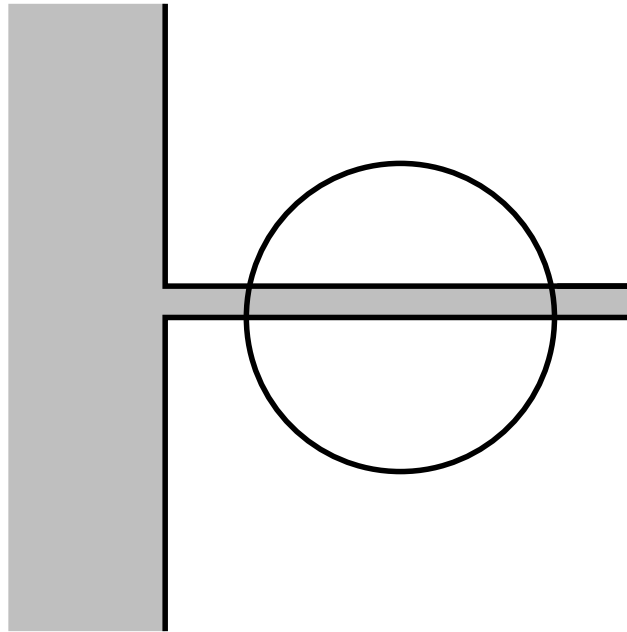

Slot field

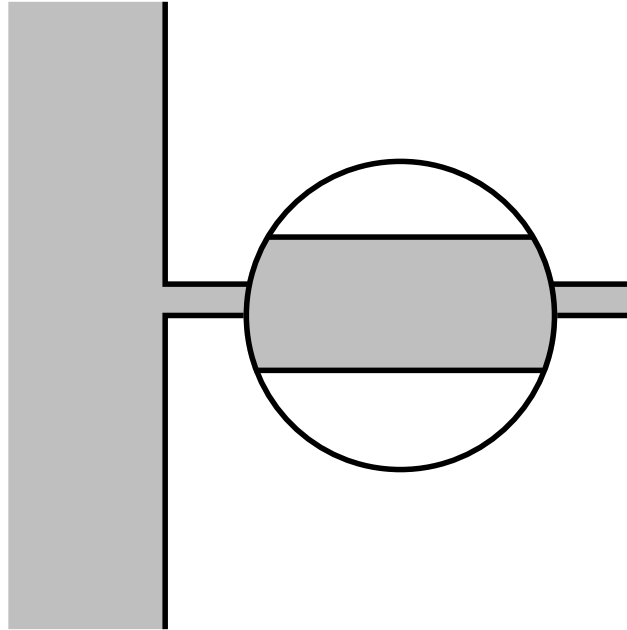

$$u^\varepsilon(x, y) = U^\varepsilon\left(x, \frac{y}{\varepsilon}\right)$$

Slot field

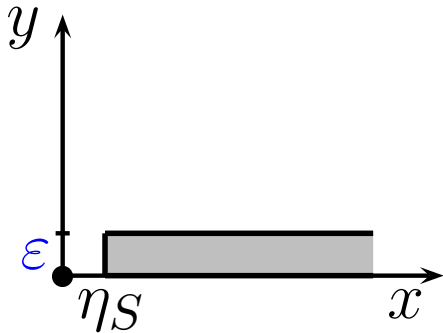

The **asymptotic** context: $\varepsilon \ll \eta_S \ll \lambda$.

The **normalization**: $X = x, \quad Y = \frac{y}{\varepsilon}$

Slot field

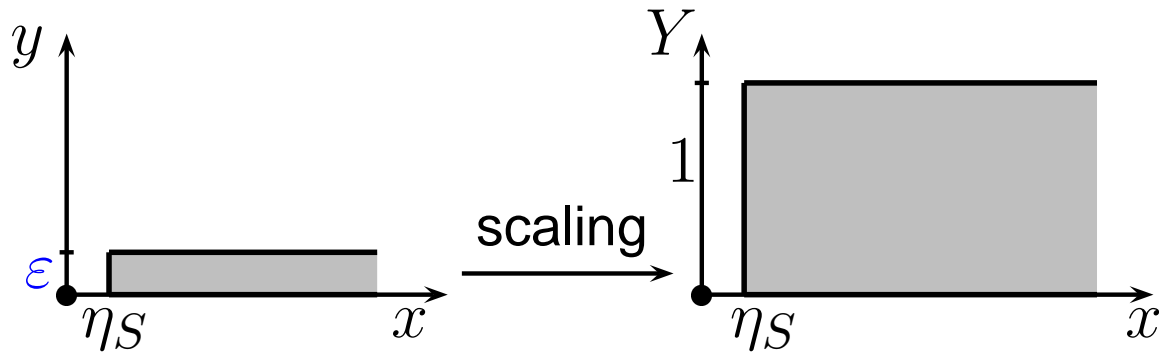

The **asymptotic** context: $\varepsilon \ll \eta_S \ll \lambda$.

The **normalization**: $X = x, \quad Y = \frac{y}{\varepsilon}$

Slot field

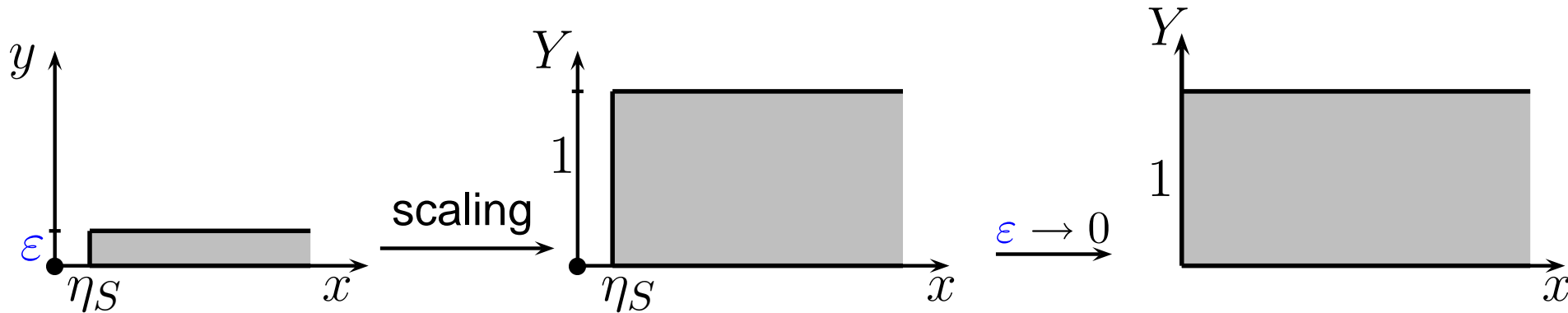

The **asymptotic** context: $\epsilon \ll \eta_S \ll \lambda$.

The **normalization**: $X = x, \quad Y = \frac{y}{\epsilon}$

Slot field

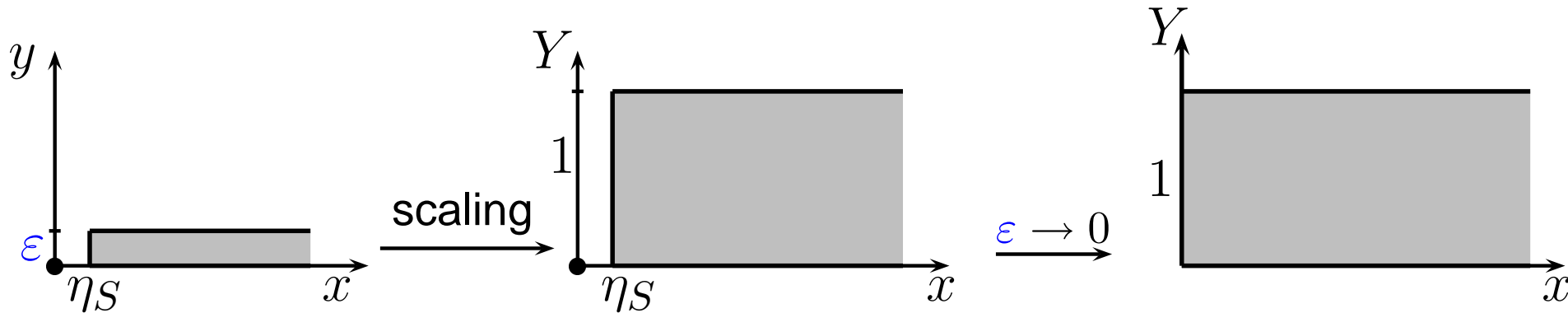

$$u^\varepsilon(x, Y\varepsilon) = U^\varepsilon(x, Y) = \sum_{i=0}^{+\infty} \sum_{k=0}^i \varepsilon^i (\log \varepsilon)^k U_i^k(x, Y) + o(\varepsilon^\infty),$$

Slot field

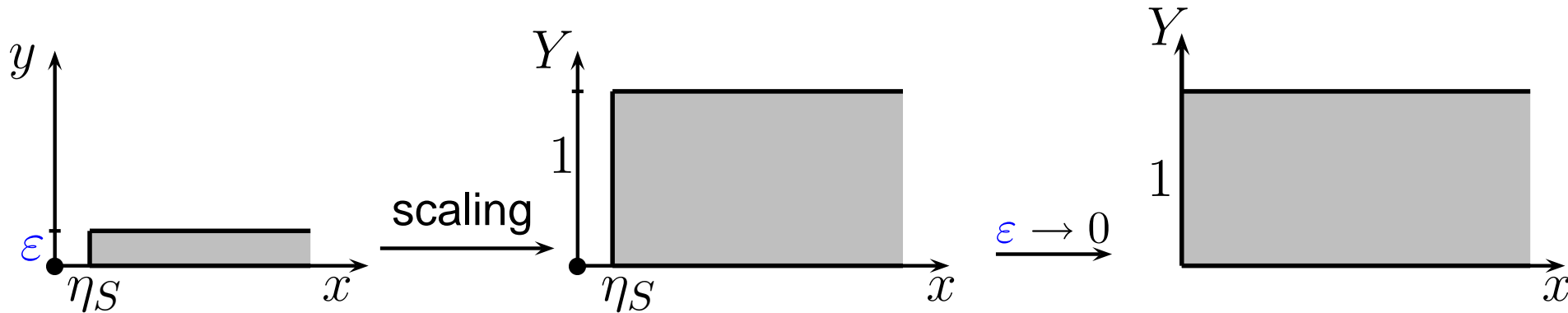

where the U_i^k satisfy the **1D Helmholtz** equation:

$$\frac{d^2 U_i^k}{dx^2} + \omega^2 U_i^k = 0$$

Near field

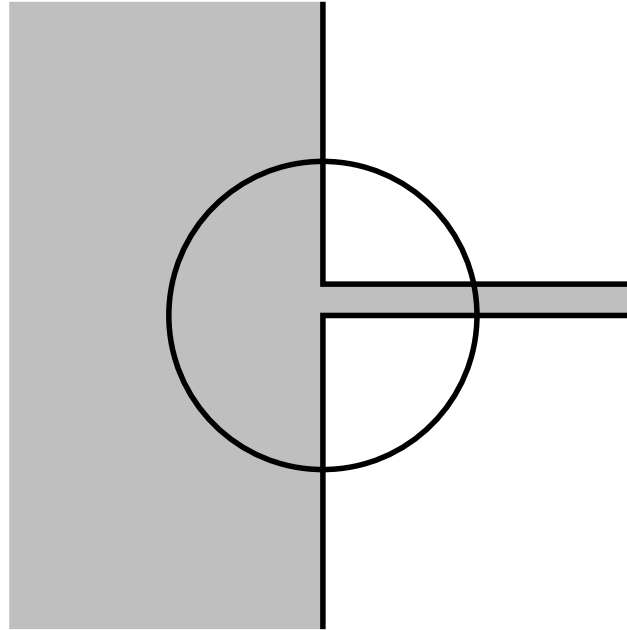

Near field

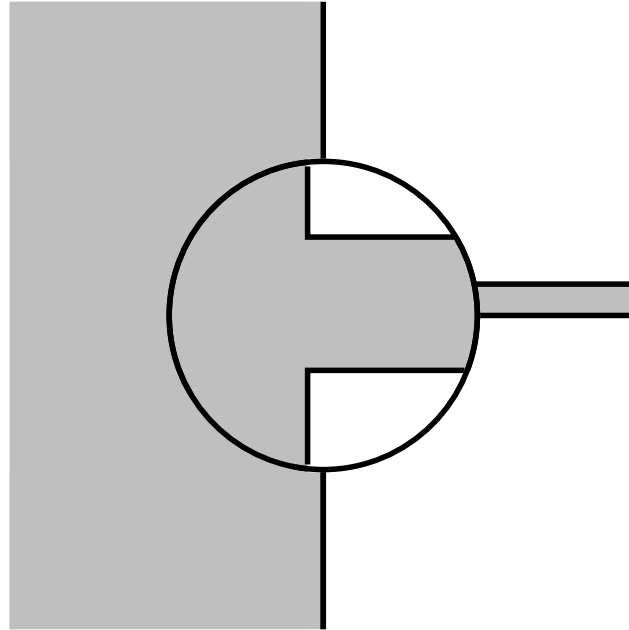

$$u^\varepsilon(x, y) = u_p^\varepsilon\left(\frac{x}{\varepsilon}, \frac{y}{\varepsilon}\right)$$

Near field

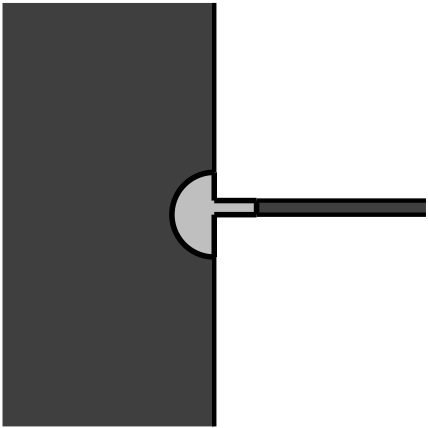

The **Asymptotic** context: $\varepsilon \ll \eta_H \ll \lambda$, $\varepsilon \ll \eta_S \ll \lambda$.

The **normalization**: $X = \frac{x}{\varepsilon}$, $Y = \frac{y}{\varepsilon}$

Near field

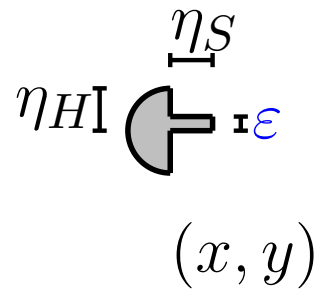

The **Asymptotic** context: $\epsilon \ll \eta_H \ll \lambda$, $\epsilon \ll \eta_S \ll \lambda$.

The **normalization**: $X = \frac{x}{\epsilon}$, $Y = \frac{y}{\epsilon}$

Near field

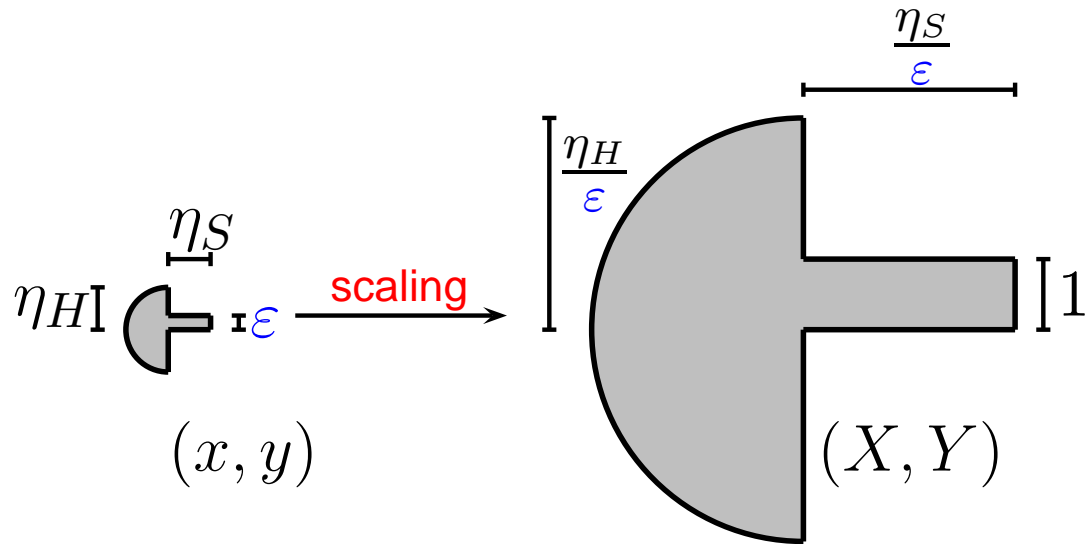

The **Asymptotic** context: $\epsilon \ll \eta_H \ll \lambda$, $\epsilon \ll \eta_S \ll \lambda$.

The **normalization**: $X = \frac{x}{\epsilon}$, $Y = \frac{y}{\epsilon}$

Near field

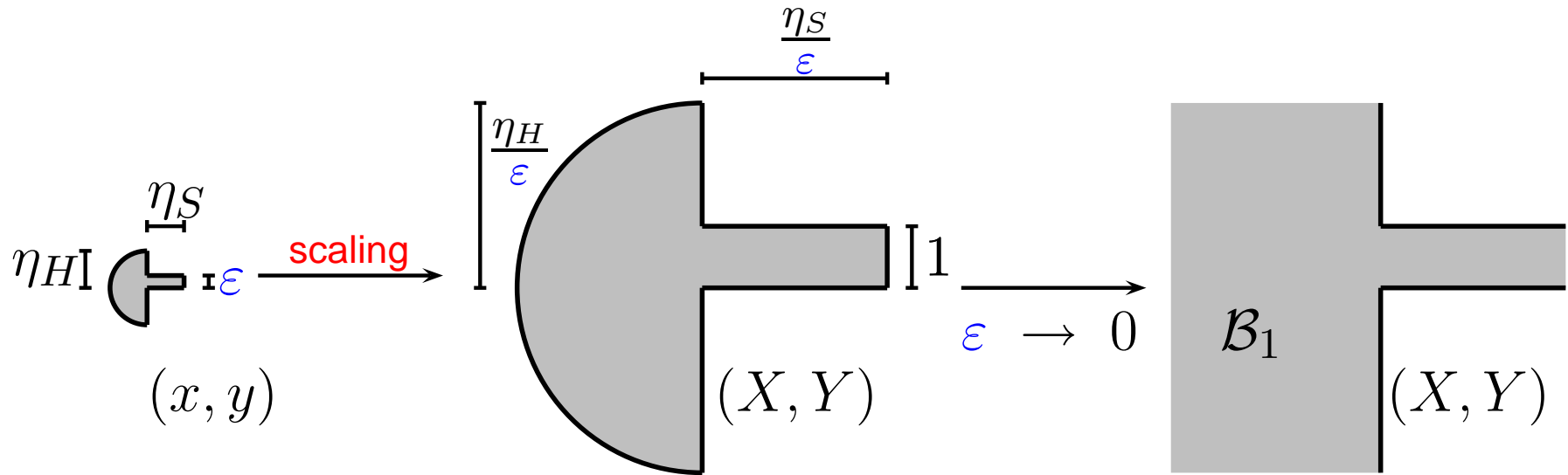

The **Asymptotic** context: $\varepsilon \ll \eta_H \ll \lambda$, $\varepsilon \ll \eta_S \ll \lambda$.

The **normalization**: $X = \frac{x}{\varepsilon}$, $Y = \frac{y}{\varepsilon}$

Near field

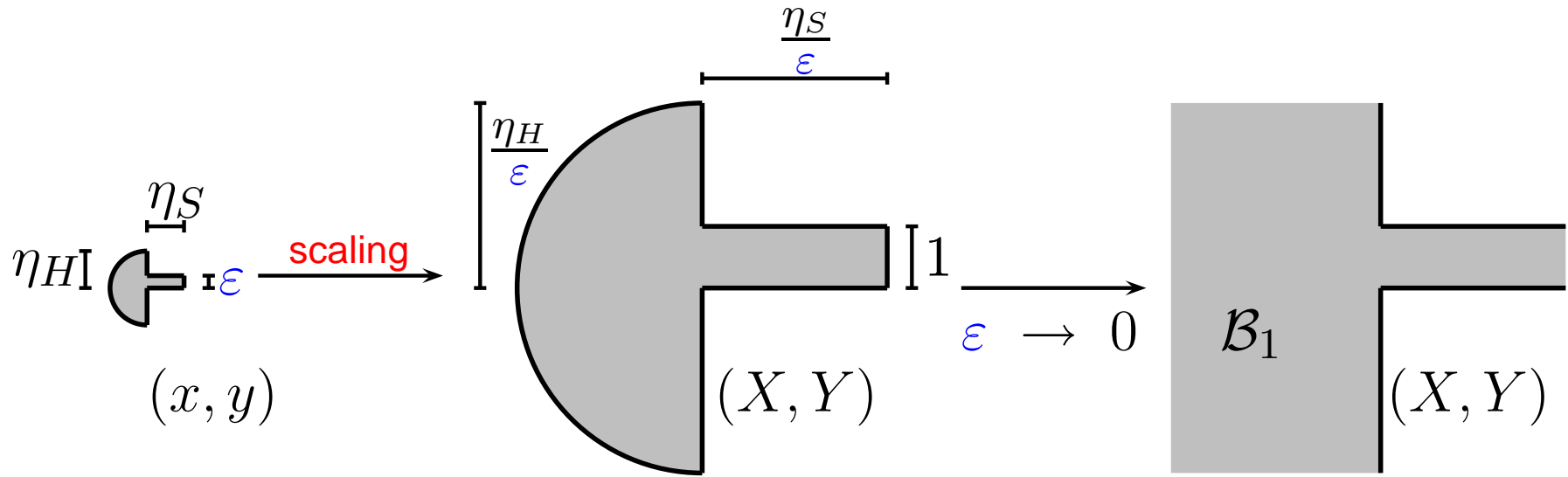

$$u^\epsilon(\epsilon X, \epsilon Y) = u_p^\epsilon(X, Y) = \sum_{i=0}^{+\infty} \sum_{k=0}^i \epsilon^i (\log \epsilon)^k (u_p)_i^k(X, Y) + o(\epsilon^\infty)$$

Near field

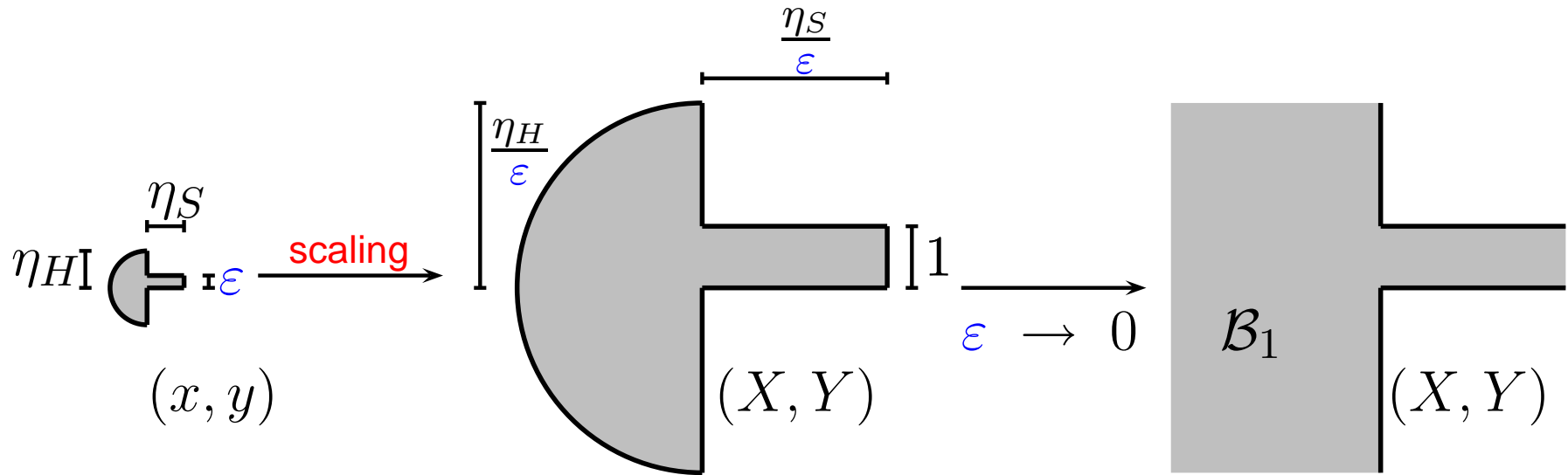

where the $(u_p)_i^k$ satisfy the (in)-homogeneous Laplace equation.

$$\begin{cases} \Delta(u_p)_i^k = 0, & \text{if } i = k \text{ or } k + 1, \\ \Delta(u_p)_i^k = -\omega^2 (u_p)_{i-2}^k, & \text{else.} \end{cases}$$

Order 0 : \underline{u}^0 , $(u_p)_0^0$, U_0^0

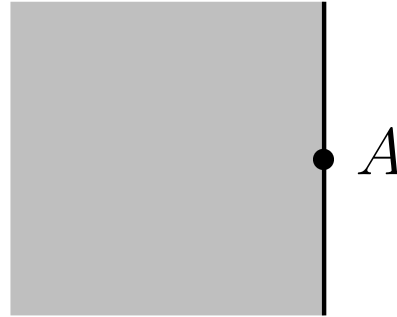

Far field:

$$\left\{ \begin{array}{l} \text{Find } u^0 \in H_{loc}^1(\Omega) \text{ such that :} \\ -\Delta u^0 - \omega^2 u^0 = f, \quad \text{in } \Omega, \\ \frac{\partial u^0}{\partial n} = 0, \quad \text{on } \partial\Omega, \\ u^0 \text{ is outgoing.} \end{array} \right.$$

Order 0 : u^0 , $\underline{(u_p)_0^0}$, U_0^0

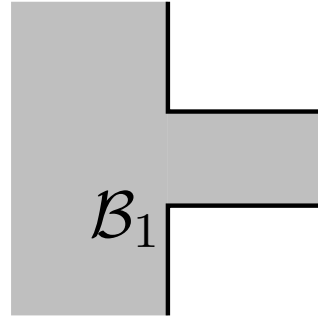

Near field:

$$(u_p)_0^0(X, Y) = u^0(A), \quad \text{in } \mathcal{B}_1.$$

Order 0 : u^0 , $(u_p)_0^0$, U_0^0

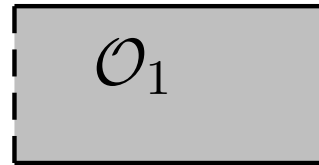

Slot field:

$$U_0^0(x, Y) = u^0(A) \exp(i\omega x), \quad \text{in } \mathcal{O}_1.$$

Order 1 : \underline{u}_1^0 , $(u_p)_1^0$, $(u_p)_1^1$, U_1^0 , U_1^1

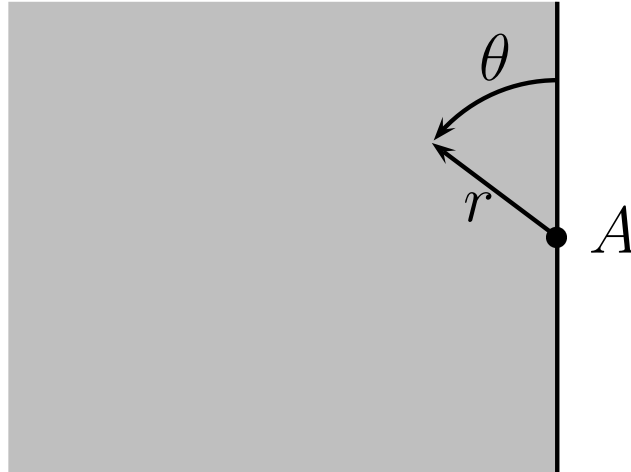

Approximation of the exact Solution:

$$u^\varepsilon \approx u^0 + \varepsilon u_1^0$$

Order 1 : \underline{u}_1^0 , $(u_p)_1^0$, $(u_p)_1^1$, U_1^0 , U_1^1

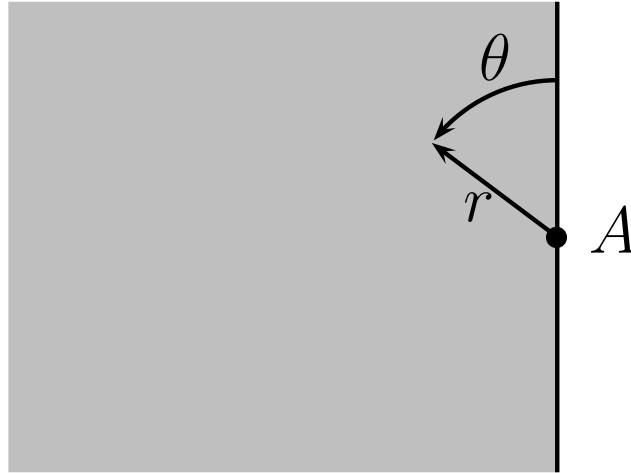

explicit form of u_1^0

$$u_1^0(r, \theta) = -\frac{\omega}{2} u^0(A) H_0^{(1)}(\omega r).$$

Order 1 : u_1^0 , $\underline{(u_p)_1^0}$, $\underline{(u_p)_1^1}$, U_1^0 , U_1^1

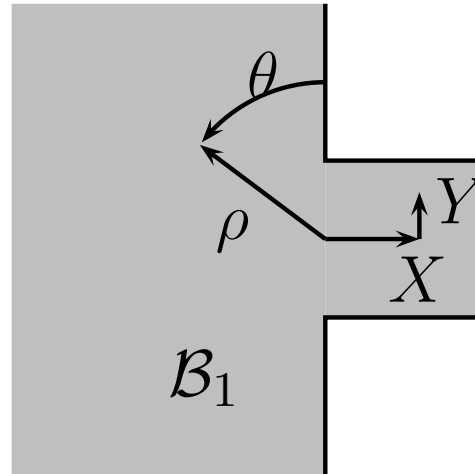

Approximation of the exact solution:

$$\begin{cases} u^\varepsilon(\varepsilon X, \varepsilon Y) = u_p^\varepsilon(X, Y), \\ u_p^\varepsilon \simeq (u_p)_0^0 + \varepsilon (u_p)_1^0 + \varepsilon \log \varepsilon (u_p)_1^1. \end{cases}$$

Order 1 : u_1^0 , $\underline{(u_p)_1^0}$, $(u_p)_1^1$, U_1^0 , U_1^1

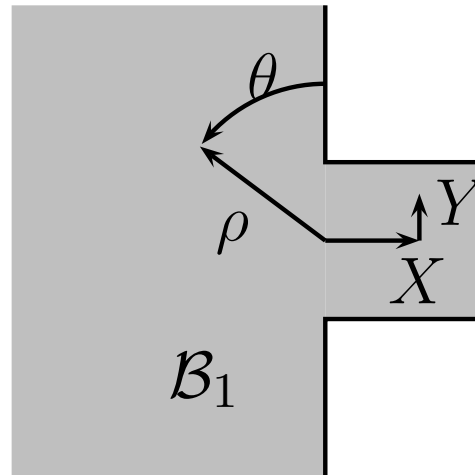

Near field:

Find $(u_p)_1^0 \in H_{loc}^1(\mathcal{B}_1)$ such that:

$$\begin{cases} \Delta(u_p)_1^0 = 0, & \text{in } \mathcal{B}_1 \\ \frac{\partial(u_p)_1^0}{\partial n} = 0, & \text{on } \partial\mathcal{B}_1. \end{cases}$$

Order 1 : u_1^0 , $\underline{(u_p)_1^0}$, $(u_p)_1^1$, U_1^0 , U_1^1

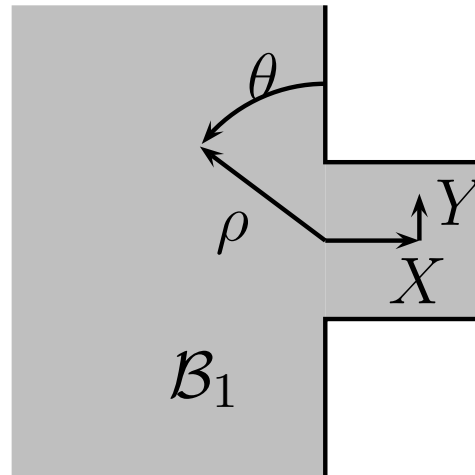

Behavior at infinity in the half-space:

$$(u_p)_1^0(\rho, \theta) - \frac{\partial u^0}{\partial y}(A) \rho \cos \theta + \frac{\omega}{2} u^0(A) \left[1 + \frac{2i}{\pi} (\log \rho + \gamma) \right] = O\left(\frac{1}{\rho}\right).$$

Order 1 : u_1^0 , $\underline{(u_p)_1^0}$, $(u_p)_1^1$, U_1^0 , U_1^1

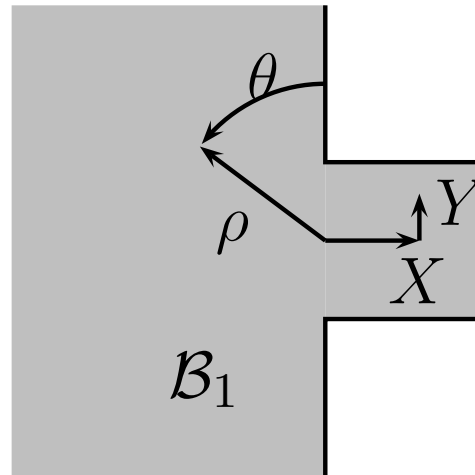

Behavior at infinity in the half-space:

$$(u_p)_1^0(\rho, \theta) - \frac{\partial u^0}{\partial y}(A) \rho \cos \theta + \frac{\omega}{2} u^0(A) \left[1 + \frac{2i}{\pi} (\log \rho + \gamma) \right] = O\left(\frac{1}{\rho}\right).$$

Behavior at infinity in the slot:

$$(u_p)_1^0(X, Y) - i \omega u^0(A) X = O(1).$$

Order 1 : u_1^0 , $(u_p)_1^0$, $\underline{(u_p)_1^1}$, U_1^0 , U_1^1

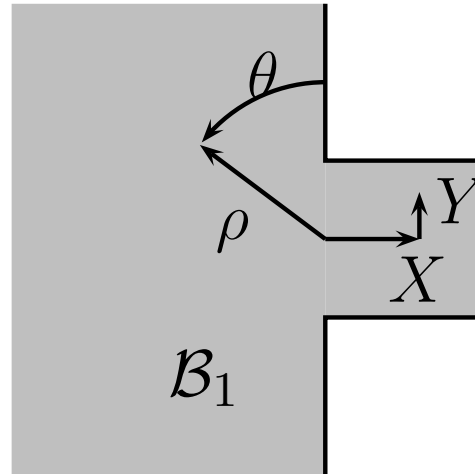

$$(u_p)_1^1 = -\frac{\mathbf{i}\omega}{\pi} u^0(A)$$

Order 1 : u_1^0 , $(u_p)_1^0$, $(u_p)_1^1$, U_1^0 , U_1^1

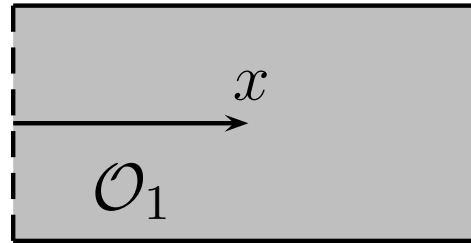

Approximation of the exact solution:

$$\begin{cases} u^\varepsilon(x, \varepsilon Y) = U^\varepsilon(x, Y), \\ U^\varepsilon \simeq U_0^0 + \varepsilon U_1^0 + \varepsilon \log \varepsilon U_1^1. \end{cases}$$

Order 1 : u_1^0 , $(u_p)_1^0$, $(u_p)_1^1$, U_1^0 , U_1^1

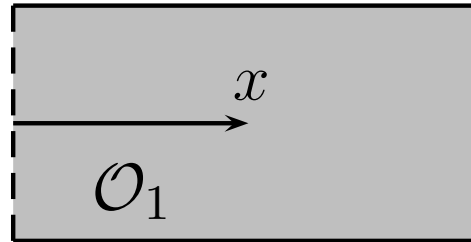

The slot field:

$$U_1^0(x) = \int_0^1 \mathcal{U}_1^0(0, Y) dY \exp(\mathbf{i}\omega x),$$

Order 1 : u_1^0 , $(u_p)_1^0$, $(u_p)_1^1$, U_1^0 , U_1^1

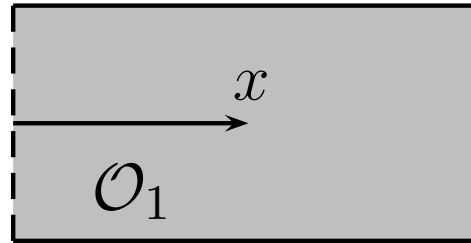

The slot field:

$$U_1^1(x) = -\frac{\mathbf{i}\omega}{\pi} u^0(A) \exp(\mathbf{i}\omega x).$$

The far field of order $i > 1$

- The field u_i^k are defined in the **half space**:

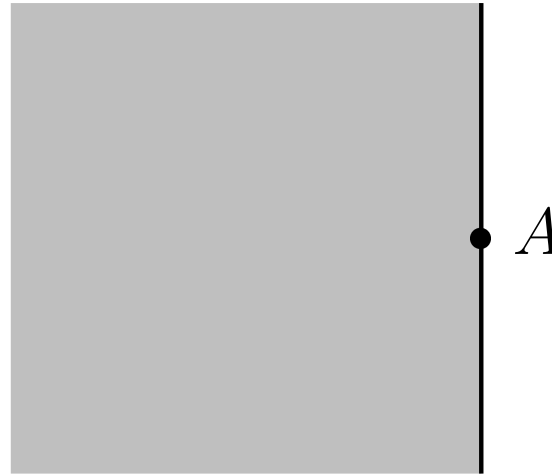

The far field of order $i > 1$

- The field u_i^k are defined in the **half space**:

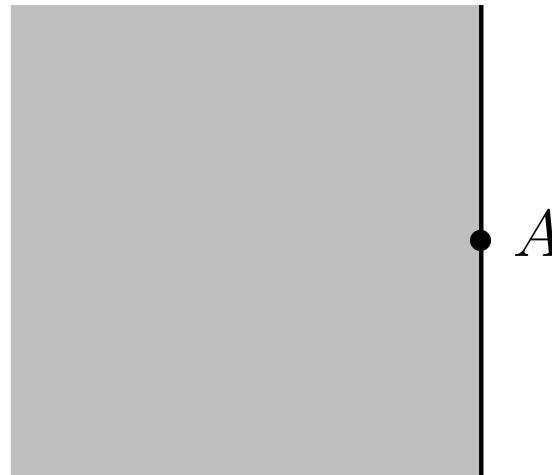

- The far fields u_i^k
 - satisfy the **homogeneous Helmholtz** equation
 - are **singular** at the neighborhood of the origin
 - are outgoing at infinity

The far field of order $i > 1$

- The field u_i^k are defined in the **half space**:

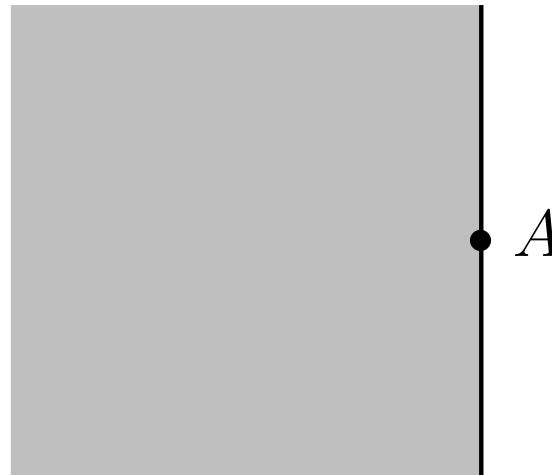

- $$u_i^k = \sum_{p=0}^{+\infty} a_p H_p^{(1)}(\omega r) \cos p\theta$$

The far field of order $i > 1$

- The field u_i^k are defined in the **half space**:

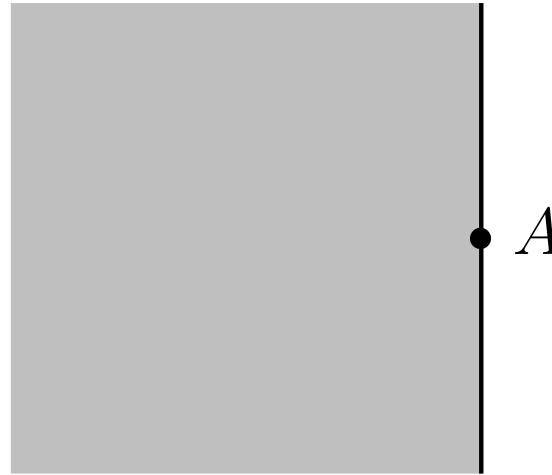

- $$u_i^k = \sum_{p=0}^{i-k-1} a_p H_p^{(1)}(\omega r) \cos p\theta$$

The far field of order $i > 1$

- The field u_i^k are defined in the **half space**:

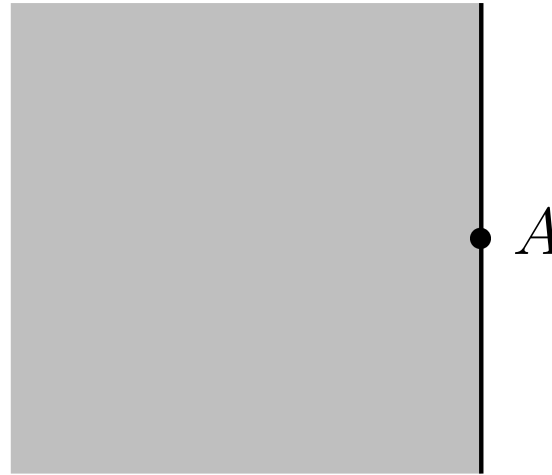

- $$u_i^k = \sum_{p=0}^{i-k-1} a_p H_p^{(1)}(\omega r) \cos p\theta$$

The a_p are functions of **lower order** terms

The far field of order $i > 1$

- The field u_i^k are defined in the **half space**:

$$\text{Im}(H_0^{(1)}(\omega r))$$

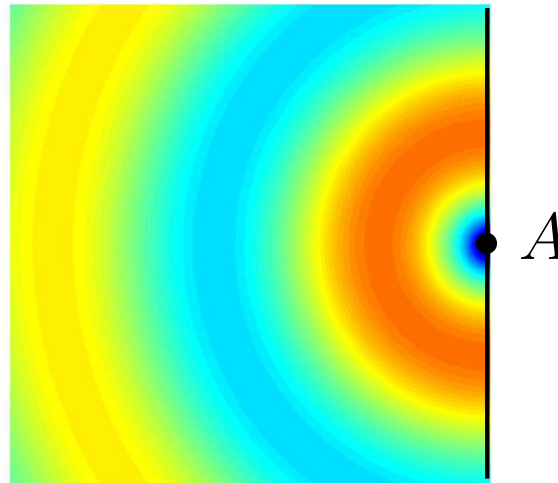

- $$u_i^k = \sum_{p=0}^{i-k-1} a_p H_p^{(1)}(\omega r) \cos p\theta$$

The a_p are functions of **lower order** terms

The far field of order $i > 1$

- The field u_i^k are defined in the **half space**:

$$\text{Im}(H_1^{(1)}(\omega r) \cos \theta)$$

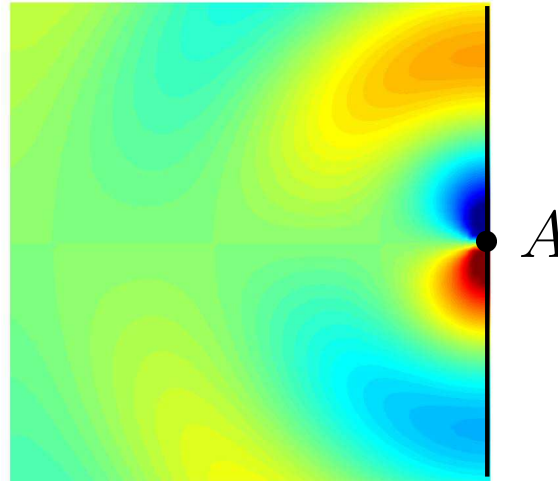

- $$u_i^k = \sum_{p=0}^{i-k-1} a_p H_p^{(1)}(\omega r) \cos p\theta$$

The a_p are functions of **lower order** terms

The near fields of order $i > 1$

- The $(u_p)_i^k(X, Y)$ are defined in the **canonical** domain:

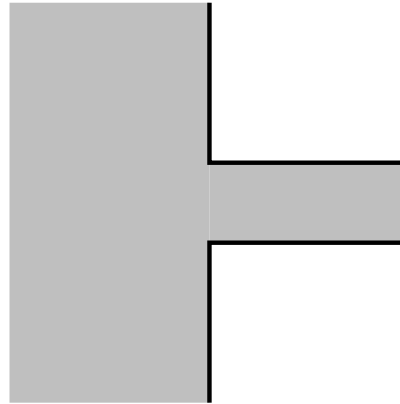

The near fields of order $i > 1$

- The $(u_p)_i^k(X, Y)$ are defined in the **canonical** domain:

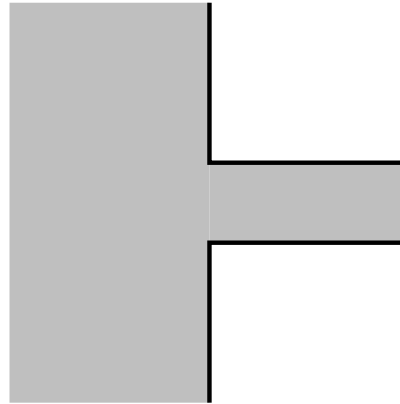

- by **Laplace** equation:

$$\Delta(u_p)_i^k = 0, \quad (i = k \text{ ou } k + 1),$$

$$\Delta(u_p)_i^k = -\omega^2 (u_p)_{i-2}^k, \quad (i \geq k + 2),$$

The near fields of order $i > 1$

- The $(u_p)_i^k(X, Y)$ are defined in the **canonical** domain:

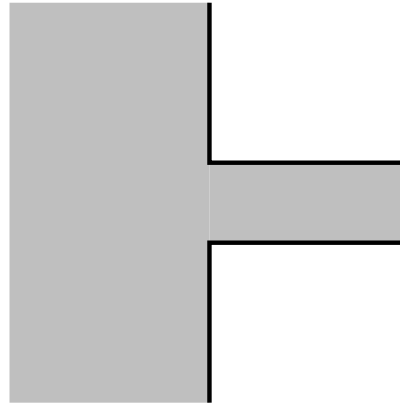

- by **Laplace** equation:
- by polynomial **growings** at infinity:
 - The **growings** in the half space are functions of **far field of lower (or equal) order**
 - The **growings** in the slot are functions of the slot fields **of lower order**

The near fields of order $i > 1$

- The $(u_p)_i^k(X, Y)$ are defined in the **canonical** domain:

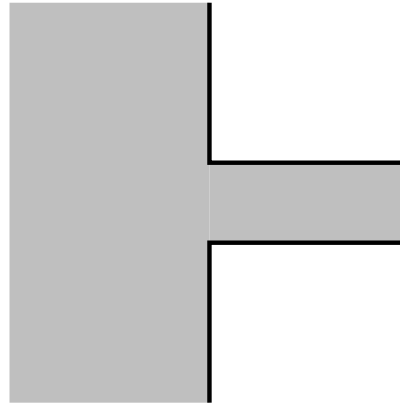

- Proof of the **existence-unicity**:
 - with truncature functions, we subtract the growing behavior at infinity of the $(u_p)_i^k$
 - We use the “classical” **variational theory** (wheighted Sobolev spaces, Leroux, Hardy,...)

The slot field of order $i > 1$

- The U_i^k are defined on the **canonical** domain:

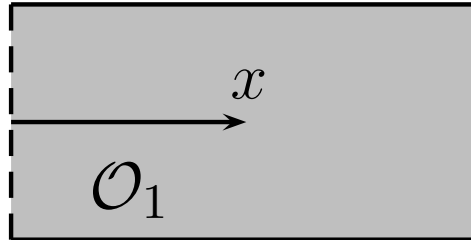

The slot field of order $i > 1$

- The U_i^k are defined on the **canonical** domain:

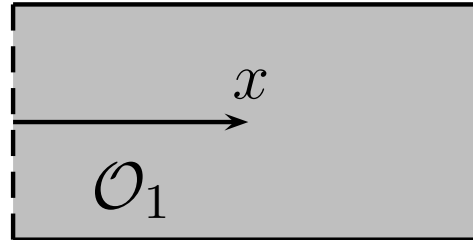

- The U_i^k does not depend on y .

The slot field of order $i > 1$

- The U_i^k are defined on the **canonical** domain:

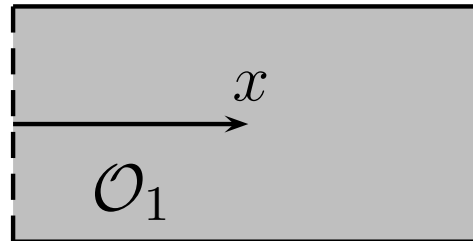

- The U_i^k does not depend on y .

- $$U_i^k(x) = \int_0^1 (u_p)_i^k(0, Y) dY \exp i\omega x$$

Some properties

We see that:

- More $i - k$ is **large** more u_i^k is **singular** at the origin:

$$r^{-p} \text{ terms, } p = 0, \dots, i - k - 1$$

Some properties

We see that:

- More $i - k$ is **large** more u_i^k is **singular** at the origin:

$$r^{-p} \text{ terms, } p = 0, \dots, i - k - 1$$

- More $i - k$ is **large** more $(u_p)_i^k$ is **growing**:

$$\begin{cases} \rho^p \text{ terms, } p = 0, \dots, i - k, \\ X^p \text{ terms, } p = 0, \dots, i - k, \end{cases}$$

Some properties

We see that:

- More $i - k$ is **large** more u_i^k is **singular** at the origin:

$$r^{-p} \text{ terms, } p = 0, \dots, i - k - 1$$

- More $i - k$ is **large** more $(u_p)_i^k$ is **growing**:

$$\begin{cases} \rho^p \text{ terms, } p = 0, \dots, i - k, \\ X^p \text{ terms, } p = 0, \dots, i - k, \end{cases}$$

- When the **order** i grows, one has $O(\frac{i^2}{2})$ ($\times 3$) terms to compute...

Dependance diagram of the asymp. terms

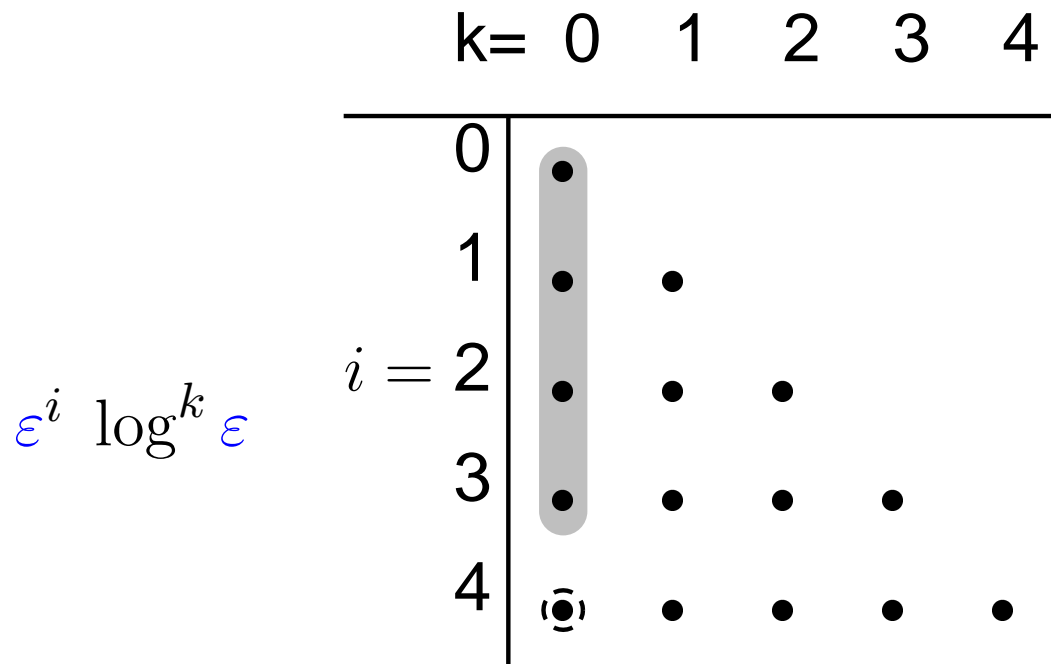

Any point corresponds to the 3 functions $(u_i^k, (u_p)_i^k, U_i^k)$.

Dependance diagram of the asymp. terms

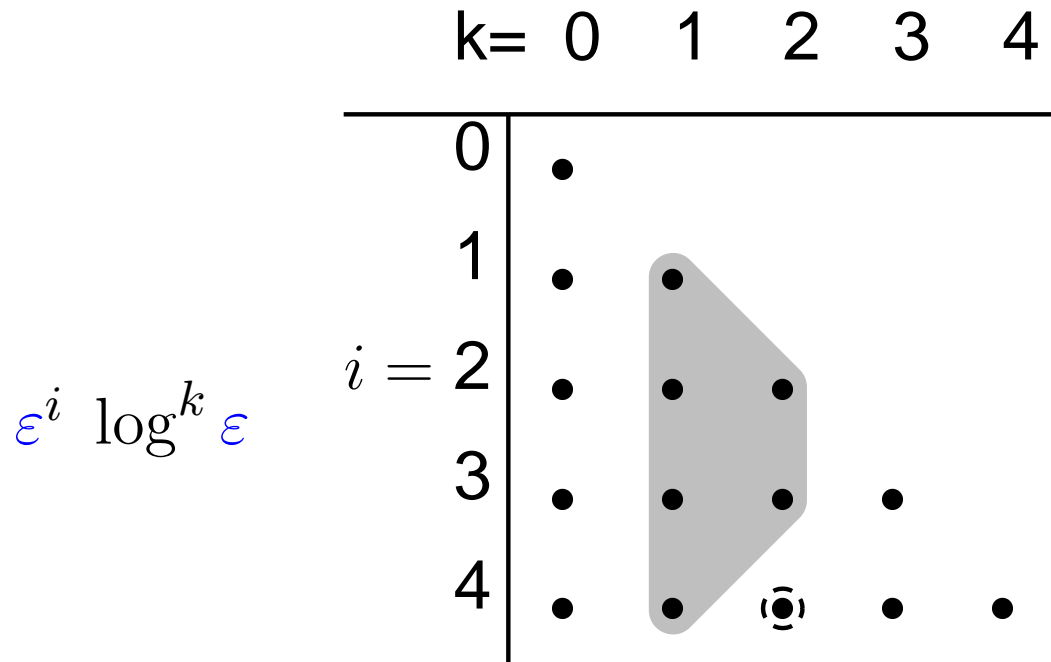

Any point corresponds to the 3 functions $(u_i^k, (u_p)_i^k, U_i^k)$.

Natural scheduling of the computations

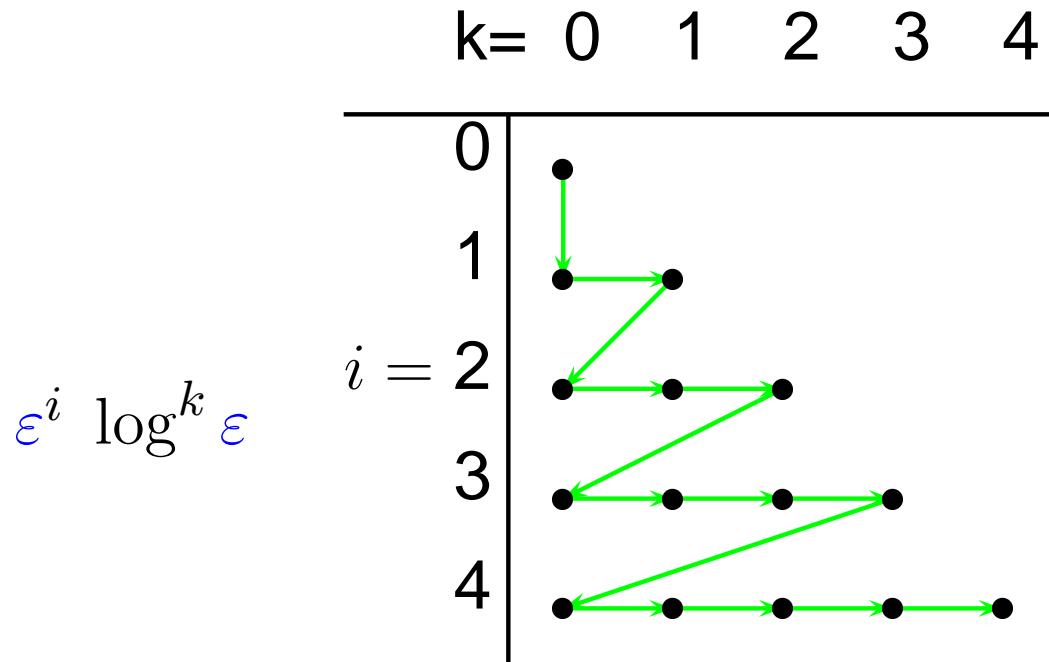

Any point corresponds to the three functions $(u_i^k, (u_p)_i^k, U_i^k)$.

Devirvate the terms of the as. exp.

- We search for solutions of the form:

$$\sum_{i \in \mathbb{Z}} \sum_{k \in \mathbb{Z}} \varepsilon^i (\log \varepsilon)^k u_i^k \quad (\text{far field})$$

$$\sum_{i \in \mathbb{Z}} \sum_{k \in \mathbb{Z}} \varepsilon^i (\log \varepsilon)^k (u_p)_i^k \quad (\text{near field})$$

$$\sum_{i \in \mathbb{Z}} \sum_{k \in \mathbb{Z}} \varepsilon^i (\log \varepsilon)^k U_i^k \quad (\text{slot field})$$

Devirvate the terms of the as. exp.

- We search for solutions of the form:

$$\sum_{i \in \mathbb{Z}} \sum_{k \in \mathbb{Z}} \varepsilon^i (\log \varepsilon)^k u_i^k \quad (\text{far field})$$

$$\sum_{i \in \mathbb{Z}} \sum_{k \in \mathbb{Z}} \varepsilon^i (\log \varepsilon)^k (u_p)_i^k \quad (\text{near field})$$

$$\sum_{i \in \mathbb{Z}} \sum_{k \in \mathbb{Z}} \varepsilon^i (\log \varepsilon)^k U_i^k \quad (\text{slot field})$$

- We **inject** the equations (Helmholtz, Neumann)

Devirvate the terms of the as. exp.

- We search for solutions of the form:

$$\sum_{i \in \mathbb{Z}} \sum_{k \in \mathbb{Z}} \varepsilon^i (\log \varepsilon)^k u_i^k \quad (\text{far field})$$

$$\sum_{i \in \mathbb{Z}} \sum_{k \in \mathbb{Z}} \varepsilon^i (\log \varepsilon)^k (u_p)_i^k \quad (\text{near field})$$

$$\sum_{i \in \mathbb{Z}} \sum_{k \in \mathbb{Z}} \varepsilon^i (\log \varepsilon)^k U_i^k \quad (\text{slot field})$$

- We **inject** the equations (Helmholtz, Neumann)
- We obtain the **coupling** conditions: (**the difficulty**)

Far-Near coupling

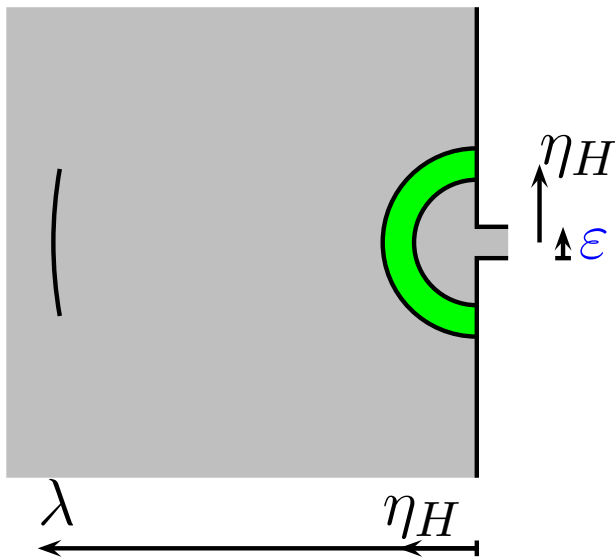

In a **thick zone**:

$$\varepsilon \ll \eta_H \ll \lambda.$$

We write the coupling condition:

$$u^\varepsilon(\eta_H, \theta) = (u_p)^\varepsilon\left(\frac{\eta_H}{\varepsilon}, \theta\right).$$

$$\sum_{i \in \mathbb{Z}} \sum_{k \in \mathbb{Z}} \varepsilon^i (\log \varepsilon)^k u_i^k(\eta_H, \theta) \simeq \sum_{i \in \mathbb{Z}} \sum_{k \in \mathbb{Z}} \varepsilon^i (\log \varepsilon)^k (u_p)_i^k\left(\frac{\eta_H}{\varepsilon}, \theta\right)$$

$$\eta_H \rightarrow 0 \qquad \frac{\eta_H}{\varepsilon} \rightarrow +\infty$$

Far-Near coupling

$$\sum_{i \in \mathbb{Z}} \sum_{k \in \mathbb{Z}} \varepsilon^i (\log \varepsilon)^k u_i^k(\eta_H, \theta) \simeq \sum_{i \in \mathbb{Z}} \sum_{k \in \mathbb{Z}} \varepsilon^i (\log \varepsilon)^k (u_p)_i^k\left(\frac{\eta_H}{\varepsilon}, \theta\right)$$

$\eta_H \rightarrow 0$ $\frac{\eta_H}{\varepsilon} \rightarrow +\infty$

We **expand**

- the left serie according to η_H near **0**
- The right serie according to η_H/ε tending ot **infinity**

We **identify** all the terms of the two series.

The conclusion of the coupling

- The **far** field-**near** field coupling:

The **singular** behavior of the **far field** is coupled with the **none growing** behavior of the **near field at infinity** .

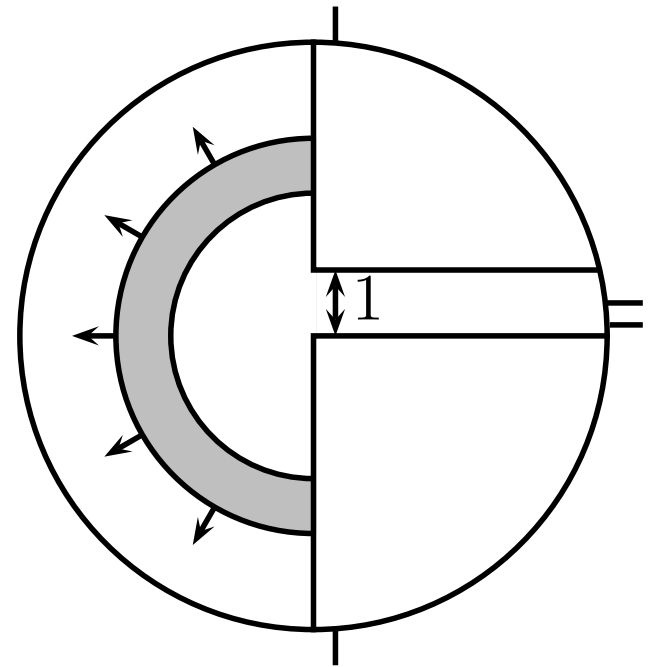
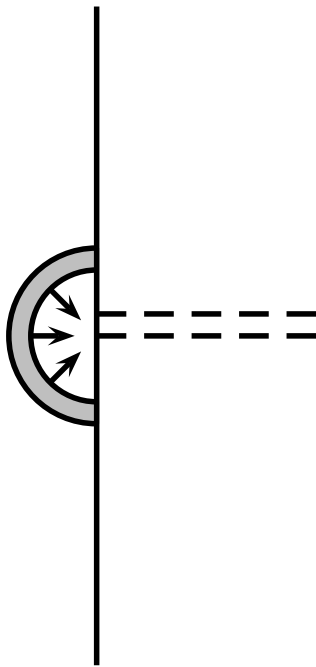

The conclusion of the coupling

- The **far** field-**near** field coupling:

The **growing** behavior of the **near field at infinity** is coupled with the **none singular** behavior of the **far field**.

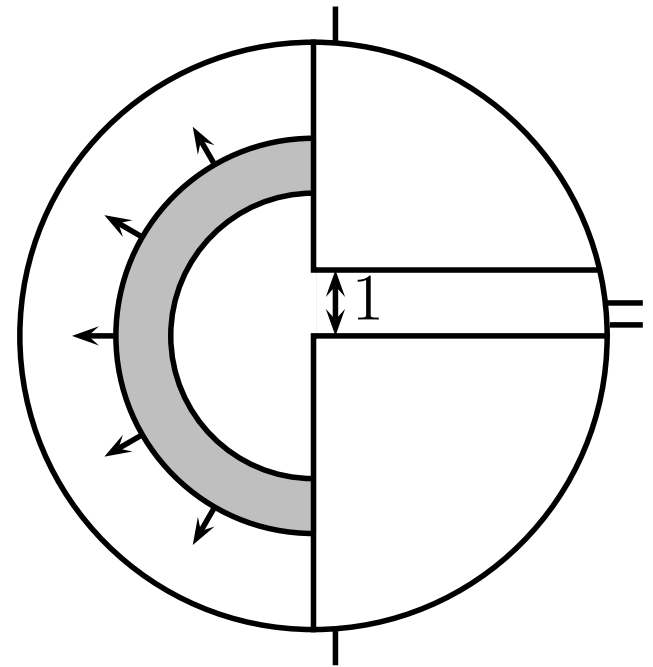
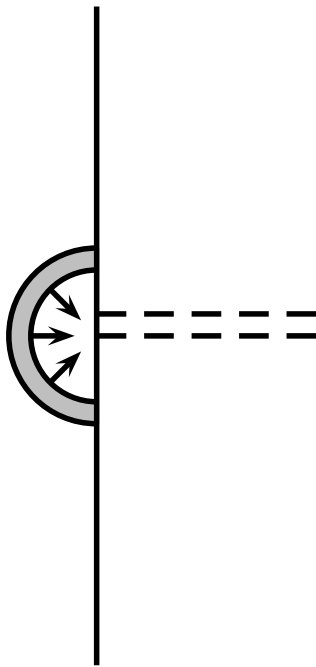

The conclusion of the coupling

- The **far** field-**near** field coupling:
- The **near** field-**slot** field coupling:

The **growing** behavior of the **near field** is coupled with the **none growing** behavior of the **slot field** (derivative values)

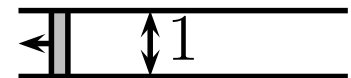
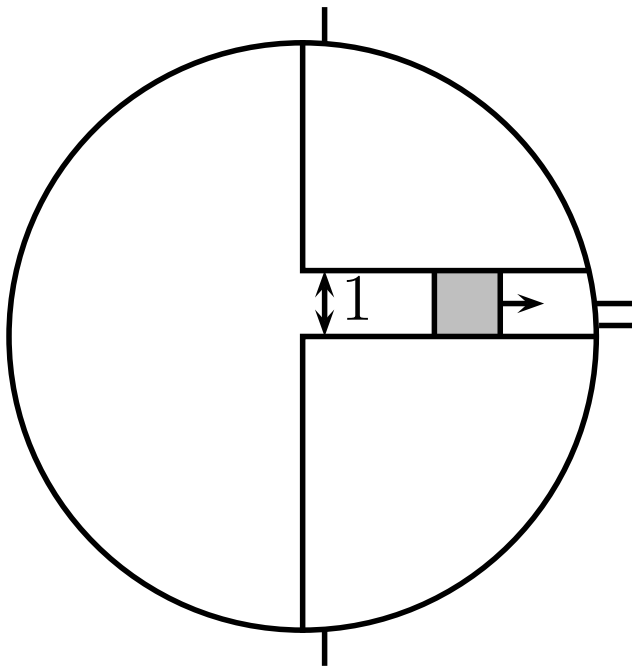

Mathematical analysis

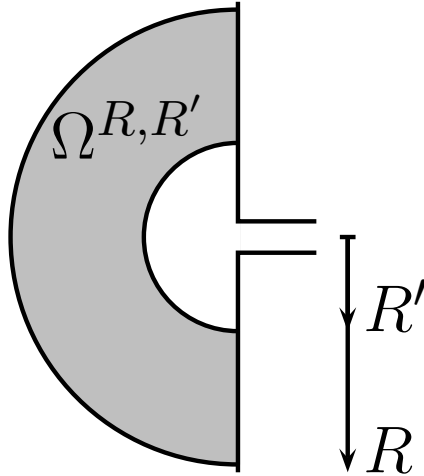

$$\left\| u^\epsilon - u^0 - \sum_{i=1}^n \sum_{k=0}^{i-1} \epsilon^i (\log \epsilon)^k u_i^k \right\|_{H^1(\Omega^{R,R'})} \leq C \epsilon^{n+1} (\log \epsilon)^n \|f\|_{L^2(\Omega)}.$$

Mathematical analysis

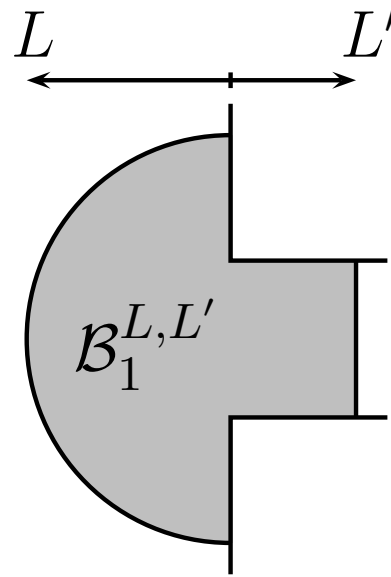
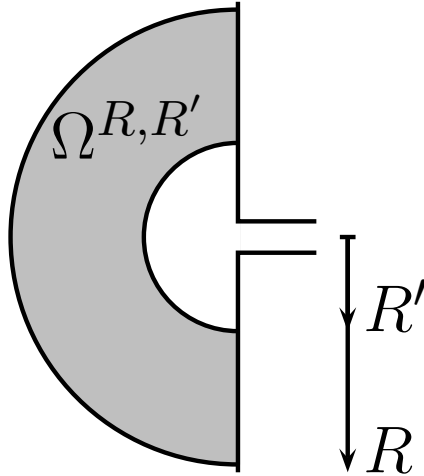

$$\left\| u^\varepsilon - u^0 - \sum_{i=1}^n \sum_{k=0}^{i-1} \varepsilon^i (\log \varepsilon)^k u_i^k \right\|_{H^1(\Omega^{R,R'})} \leq C \varepsilon^{n+1} (\log \varepsilon)^n \|f\|_{L^2(\Omega)}.$$

$$\left\| u_p^\varepsilon - \sum_{i=0}^n \sum_{k=0}^i \varepsilon^i (\log \varepsilon)^k (u_p)_i^k \right\|_{H^1(\mathcal{B}_1^{L,L'})} \leq C \varepsilon^{n+1} (\log \varepsilon)^{n+1} \|f\|_{L^2(\Omega)}.$$

Mathematical analysis

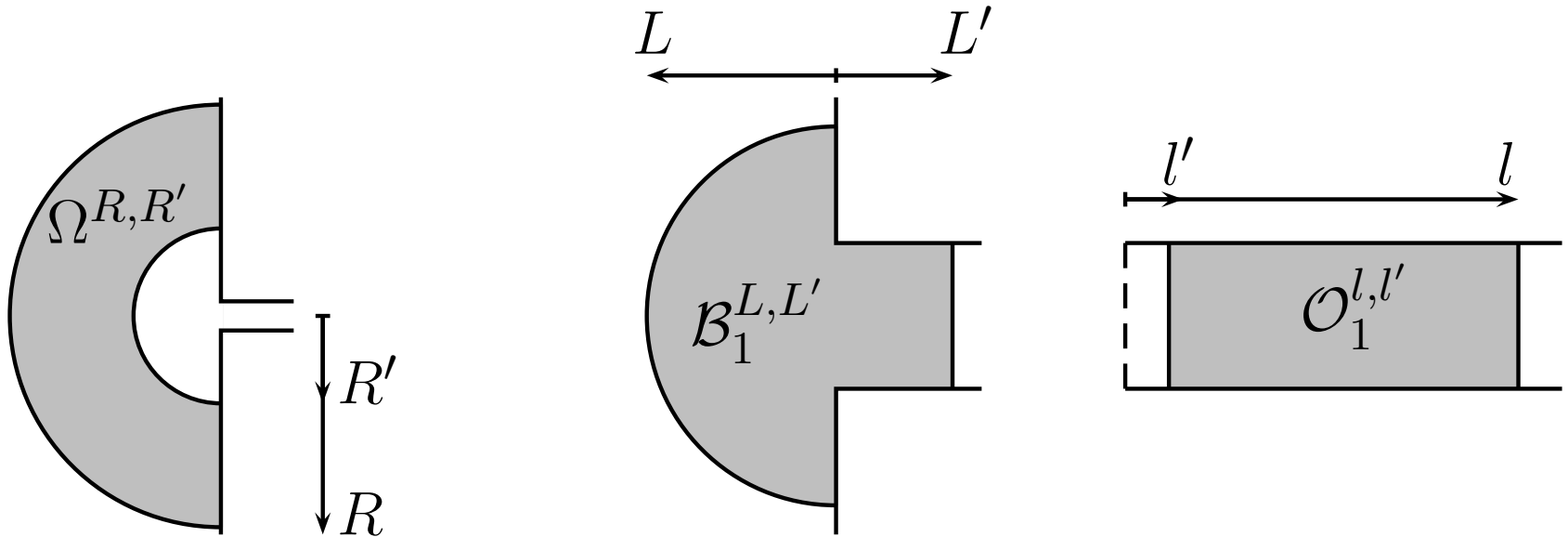

$$\left\| u^\varepsilon - u^0 - \sum_{i=1}^n \sum_{k=0}^{i-1} \varepsilon^i (\log \varepsilon)^k u_i^k \right\|_{H^1(\Omega^{R,R'})} \leq C \varepsilon^{n+1} (\log \varepsilon)^n \|f\|_{L^2(\Omega)}.$$

$$\left\| u_p^\varepsilon - \sum_{i=0}^n \sum_{k=0}^i \varepsilon^i (\log \varepsilon)^k (u_p)_i^k \right\|_{H^1(\mathcal{B}_1^{L,L'})} \leq C \varepsilon^{n+1} (\log \varepsilon)^{n+1} \|f\|_{L^2(\Omega)}.$$

$$\left\| U^\varepsilon - \sum_{i=0}^n \sum_{k=0}^i \varepsilon^i (\log \varepsilon)^k U_i^k \right\|_{H^1(\mathcal{O}_1^{l,l'})} \leq C \varepsilon^{n+1} (\log \varepsilon)^{n+1} \|f\|_{L^2(\Omega)}.$$

Idea of the proof

We want to define an **approximation** \tilde{u}_n^ε of the exact solution which **coincide** with:

- the **truncated** expansion of the **far field** away from the slot in the half space.

$$u_n^{H,\varepsilon}(x, y) = u^0(x, y) + \sum_{i=1}^n \sum_{k=0}^{i-1} \varepsilon^i (\log \varepsilon)^k u_i^k(x, y)$$

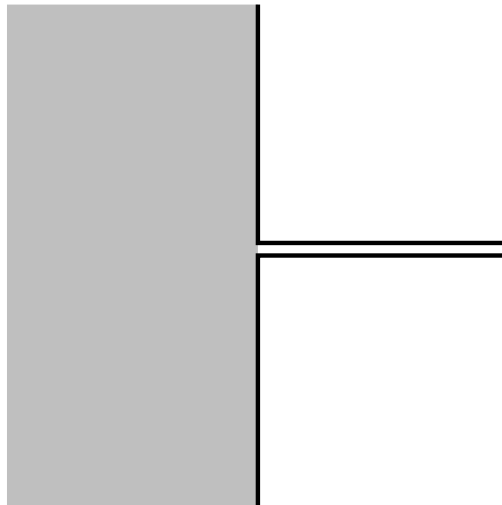

Idea of the proof

We want to define an **approximation** \tilde{u}_n^ε of the exact solution which **coincide** with:

- The **truncated** expansion of the **near field** in the neighbourhood of the end of the slot

$$u_n^{N,\varepsilon}(x, y) = \sum_{i=0}^n \sum_{k=0}^i \varepsilon^i (\log \varepsilon)^k (u_p)_i^k \left(\frac{x}{\varepsilon}, \frac{y}{\varepsilon} \right)$$

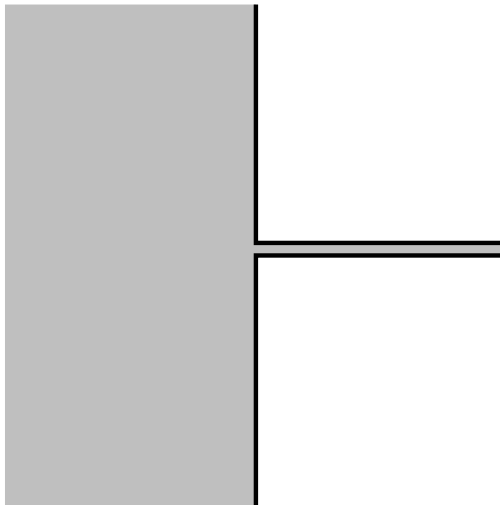

Idea of the proof

We want to define an **approximation** \tilde{u}_n^ε of the exact solution which **coincide** with:

- the **truncated** expansion of the **slot field** far away in the slot

$$u_n^{S,\varepsilon}(x, y) = \sum_{i=0}^n \sum_{k=0}^i \varepsilon^i (\log \varepsilon)^k U_i^k(x, \frac{y}{\varepsilon})$$

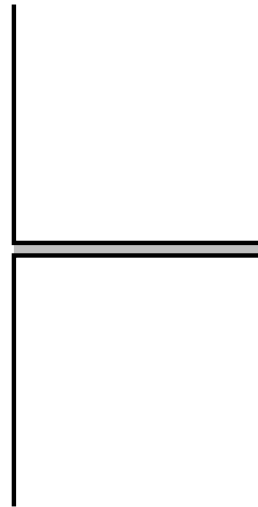

Idea of the proof

Introduce a partition of unity

$$\tilde{u}_n^\varepsilon(r, \theta) = \chi_H^\varepsilon u_n^{H,\varepsilon} + \chi_N^\varepsilon u_n^{N,\varepsilon} + \chi_S^\varepsilon u_n^{S,\varepsilon}$$

with

$$\chi_H^\varepsilon + \chi_N^\varepsilon + \chi_S^\varepsilon = 1.$$

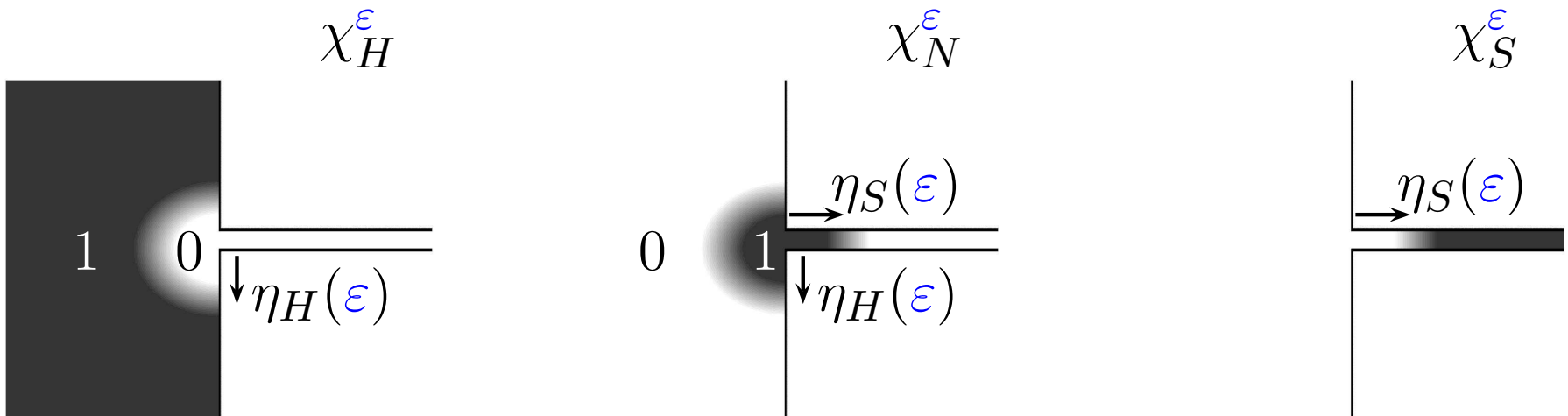

Idea of the proof

The **error** equation: $e_n^\varepsilon = \tilde{u}_n^\varepsilon - u^\varepsilon$

$$\left\{ \begin{array}{l} \Delta e_n^\varepsilon + \omega^2 e_n^\varepsilon = (\delta_N)_n^\varepsilon + (\delta_{H-N})_n^\varepsilon + (\delta_{S-N})_n^\varepsilon, \quad \text{in } \Omega_\varepsilon, \\ \frac{\partial e_n^\varepsilon}{\partial n} = 0, \quad \text{on } \partial\Omega_\varepsilon, \\ e_n^\varepsilon \text{ is outgoing.} \end{array} \right.$$

$(\delta_N)_n^\varepsilon$ is related to the **approximation** of the **Helmholtz** equation by the **near** field

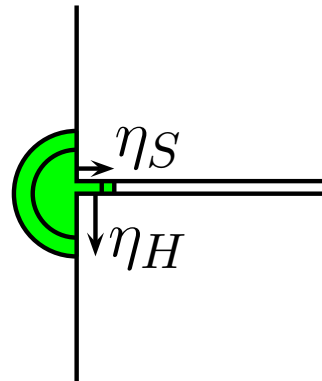

Idea of the proof

The **error** equation $e_n^\varepsilon = \tilde{u}_n^\varepsilon - u^\varepsilon$

$$\left\{ \begin{array}{l} \Delta e_n^\varepsilon + \omega^2 e_n^\varepsilon = (\delta_N)^\varepsilon_n + (\delta_{H-N})^\varepsilon_n + (\delta_{S-N})^\varepsilon_n, \quad \text{dans } \Omega_\varepsilon, \\ \frac{\partial e_n^\varepsilon}{\partial n} = 0, \quad \text{on } \partial\Omega_\varepsilon, \\ e_n^\varepsilon \text{ is outgoing.} \end{array} \right.$$

$(\delta_{H-N})^\varepsilon_n$ is related to the **matching error** between the **far** field and the **near** field

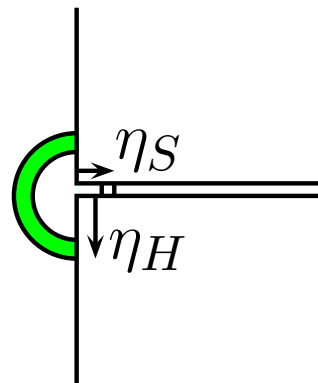

Idea of the proof

The **error** equation $e_n^\varepsilon = \tilde{u}_n^\varepsilon - u^\varepsilon$

$$\left\{ \begin{array}{l} \Delta e_n^\varepsilon + \omega^2 e_n^\varepsilon = (\delta_N)^\varepsilon_n + (\delta_{H-N})^\varepsilon_n + (\delta_{S-N})^\varepsilon_n, \quad \text{dans } \Omega_\varepsilon, \\ \frac{\partial e_n^\varepsilon}{\partial n} = 0, \quad \text{sur } \partial\Omega_\varepsilon, \\ e_n^\varepsilon \text{ is outgoing.} \end{array} \right.$$

$(\delta_{S-N})^\varepsilon_n$ is related to the **matching error** between the **slot** field and the **near** champ

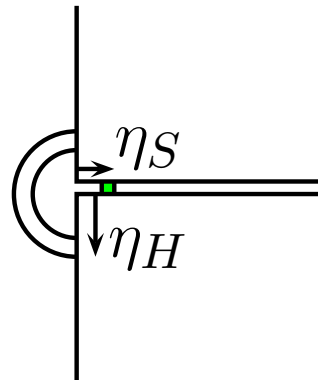

Idea of the proof

The **error** equation: $e_n^\varepsilon = \tilde{u}_n^\varepsilon - u^\varepsilon$

$$\left\{ \begin{array}{l} \Delta e_n^\varepsilon + \omega^2 e_n^\varepsilon = (\delta_N)^\varepsilon_n + (\delta_{H-N})^\varepsilon_n + (\delta_{S-N})^\varepsilon_n, \quad \text{in } \Omega_\varepsilon, \\ \frac{\partial e_n^\varepsilon}{\partial n} = 0, \quad \text{on } \partial\Omega_\varepsilon, \\ e_n^\varepsilon \text{ os outgoing.} \end{array} \right.$$

classical asymptotic techniques:

- **Stability**: proof by **contradiction** (Helmholtz)
- **Consistency**: A little bit more difficult (study of the singularities and of the growings by separation of variable)

Idea of the proof

Global error estimates

$$\left\{ \begin{array}{l} \|u^\varepsilon - \tilde{u}_n^\varepsilon\|_{H^1(\Omega_\varepsilon^{R,\delta})} \leq C \left[\left(\eta_H(\varepsilon)\right)^n + \left(\frac{\varepsilon}{\eta_H(\varepsilon)}\right)^n \right] \\ + C \left[\left(\eta_S(\varepsilon)\right)^n + \left(\frac{\varepsilon}{\eta_S(\varepsilon)}\right)^n \right]. \end{array} \right.$$

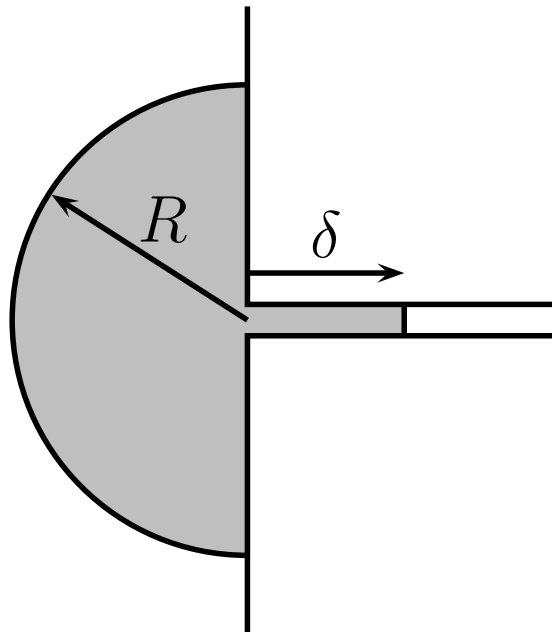

Idea of the proof

Global error estimate

$$\left\{ \begin{array}{l} \|u^\varepsilon - \tilde{u}_n^\varepsilon\|_{H^1(\Omega_\varepsilon^{R,\delta})} \leq C \left[\left(\eta_H(\varepsilon)\right)^n + \left(\frac{\varepsilon}{\eta_H(\varepsilon)}\right)^n \right] \\ \quad + C \left[\left(\eta_S(\varepsilon)\right)^n + \left(\frac{\varepsilon}{\eta_S(\varepsilon)}\right)^n \right]. \end{array} \right.$$

One can choose $\eta_H(\varepsilon)$ and $\eta_S(\varepsilon)$ to **optimize** this relation

$$\eta_H(\varepsilon) = \eta_S(\varepsilon) = \sqrt{\varepsilon}$$

This leads to

$$\|u^\varepsilon - \tilde{u}_n^\varepsilon\|_{H^1(\Omega_\varepsilon^{R,\delta})} \leq C \varepsilon^{\frac{n}{2}}$$

Idea of the proof

$$\|u^\varepsilon - \tilde{u}_n^\varepsilon\|_{H^1(\Omega_\varepsilon^{R,\delta})} \leq C \varepsilon^{\frac{n}{2}}$$

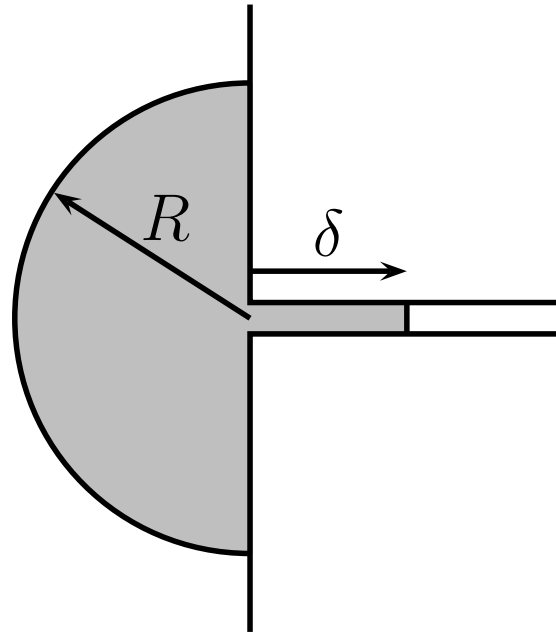

Idea of the proof

$$\|u^\varepsilon - \tilde{u}_n^\varepsilon\|_{H^1(\Omega_\varepsilon^{R,\delta})} \leq C \varepsilon^{\frac{n}{2}} \implies \|u^\varepsilon - \tilde{u}_n^\varepsilon\|_{H^1(\Omega^{R,R'})} \leq C \varepsilon^{\frac{n}{2}}$$

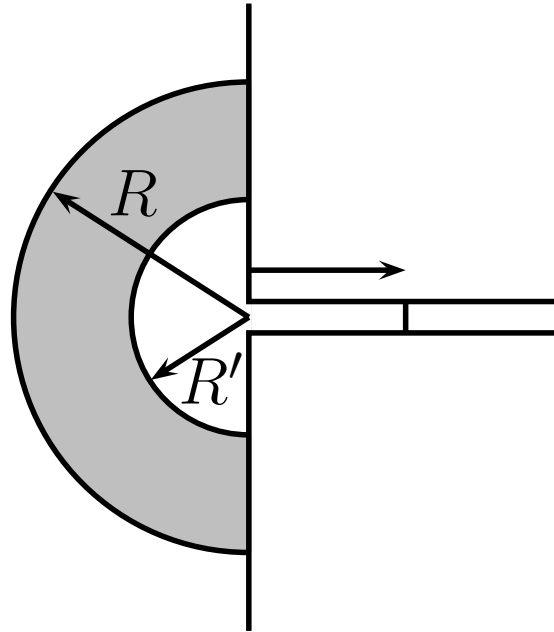

Idea of the proof

$$\|u^\varepsilon - \tilde{u}_n^\varepsilon\|_{H^1(\Omega_\varepsilon^{R,\delta})} \leq C \varepsilon^{\frac{n}{2}} \implies \|u^\varepsilon - \tilde{u}_n^\varepsilon\|_{H^1(\Omega^{R,R'})} \leq C \varepsilon^{\frac{n}{2}}$$

In the **far field** zone:

$$\tilde{u}_n^\varepsilon = u_n^{H,\varepsilon} = u^0 + \sum_{i=1}^n \sum_{k=0}^{i-1} \varepsilon^i (\log \varepsilon)^k u_i^k$$

Idea of the proof

$$\|u^\varepsilon - \tilde{u}_n^\varepsilon\|_{H^1(\Omega_\varepsilon^{R,\delta})} \leq C \varepsilon^{\frac{n}{2}} \implies \|u^\varepsilon - \tilde{u}_n^\varepsilon\|_{H^1(\Omega^{R,R'})} \leq C \varepsilon^{\frac{n}{2}}$$

In the **far field** zone:

$$\tilde{u}_n^\varepsilon = u_n^{H,\varepsilon} = u^0 + \sum_{i=1}^n \sum_{k=0}^{i-1} \varepsilon^i (\log \varepsilon)^k u_i^k$$

$$\left\{ \begin{array}{l} \|u^\varepsilon - u_{3n}^{H,\varepsilon}\|_{H^1(\Omega^{R,R'})} \leq C \varepsilon^{\frac{3n}{2}} \\ \|u_{3n}^{H,\varepsilon} - u_n^{H,\varepsilon}\|_{H^1(\Omega^{R,R'})} \leq C \varepsilon^{n+1} \log^n \varepsilon \end{array} \right.$$

Idea of the proof

$$\|u^\varepsilon - \tilde{u}_n^\varepsilon\|_{H^1(\Omega_\varepsilon^{R,\delta})} \leq C \varepsilon^{\frac{n}{2}} \implies \|u^\varepsilon - \tilde{u}_n^\varepsilon\|_{H^1(\Omega^{R,R'})} \leq C \varepsilon^{\frac{n}{2}}$$

In the **far field** zone:

$$\tilde{u}_n^\varepsilon = u_n^{H,\varepsilon} = u^0 + \sum_{i=1}^n \sum_{k=0}^{i-1} \varepsilon^i (\log \varepsilon)^k u_i^k$$

$$\begin{cases} \|u^\varepsilon - u_{3n}^{H,\varepsilon}\|_{H^1(\Omega^{R,R'})} \leq C \varepsilon^{\frac{3n}{2}} \\ \|u_{3n}^{H,\varepsilon} - u_n^{H,\varepsilon}\|_{H^1(\Omega^{R,R'})} \leq C \varepsilon^{n+1} \log^n \varepsilon \end{cases}$$

One can conclude using the **triangular inequality**.

Mathematical analysis

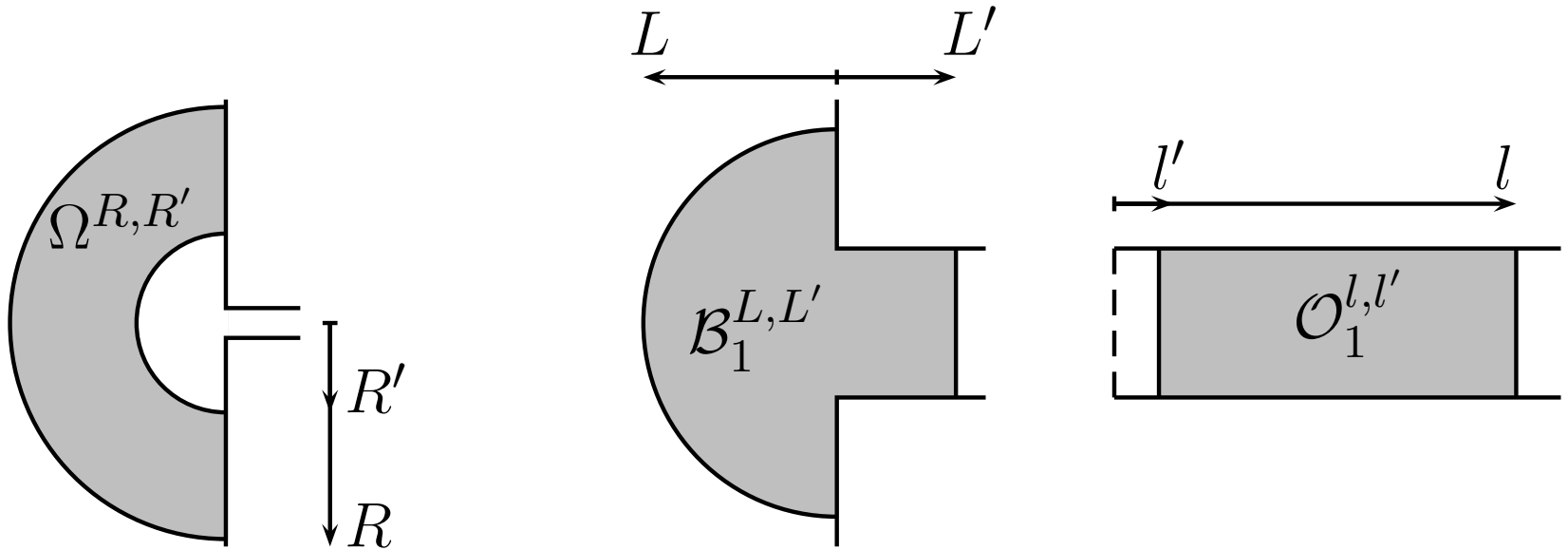

$$\left\| u^\varepsilon - u^0 - \sum_{i=1}^n \sum_{k=0}^{i-1} \varepsilon^i (\log \varepsilon)^k u_i^k \right\|_{H^1(\Omega^{R,R'})} \leq C \varepsilon^{n+1} (\log \varepsilon)^n \|f\|_{L^2(\Omega)}.$$

$$\left\| u_p^\varepsilon - \sum_{i=0}^n \sum_{k=0}^i \varepsilon^i (\log \varepsilon)^k (u_p)_i^k \right\|_{H^1(\mathcal{B}_1^{L,L'})} \leq C \varepsilon^{n+1} (\log \varepsilon)^{n+1} \|f\|_{L^2(\Omega)}.$$

$$\left\| U^\varepsilon - \sum_{i=0}^n \sum_{k=0}^i \varepsilon^i (\log \varepsilon)^k U_i^k \right\|_{H^1(\mathcal{O}_1^{l,l'})} \leq C \varepsilon^{n+1} (\log \varepsilon)^{n+1} \|f\|_{L^2(\Omega)}.$$

Perspectives

1. Mathematical analysis of the finite slot (**resonance** phenomena)

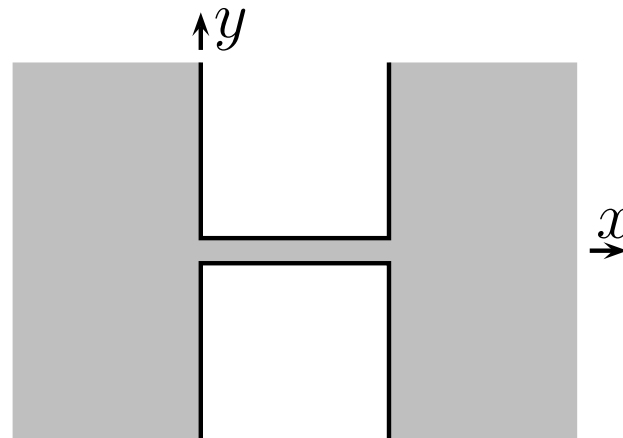

The difficulty: the **stability** result.

Perspectives

1. Mathematical analysis of the finite slot (**resonance** phenomena)
2. Comparison with the **multi-scale** technique

Perspectives

1. Mathematical analysis of the finite slot (**resonance** phenomena)
2. Comparison with the **multi-scale** technique
3. The 3D **Maxwell** equation

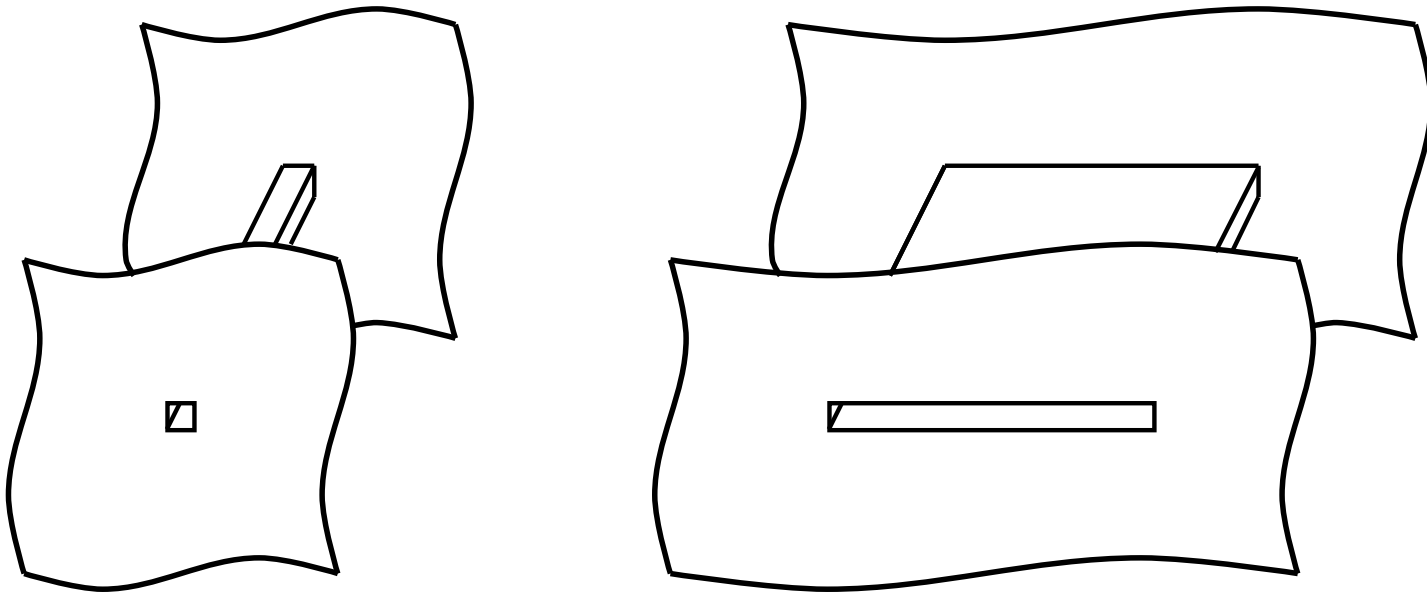

Perspectives

1. Mathematical analysis of the finite slot (**resonance** phenomena)
2. Comparison with the **multi-scale** technique
3. The 3D **Maxwell** equation
4. The **time domain** (evolution equation)

$$\frac{\partial^2 u}{\partial t^2} - c^2 \Delta u = 0.$$